

**Наименование на материала:**

**Триполюсни и еднополюсни стопяем  
цилиндричен**

**предпазител-прекъсвач-разединители,  
размер 10x38 mm**

**Номер на техническа спецификация на  
стандарт - 20 17 60zzкъм**

**МКТП(II) 20/800(630) – Т53**

**и**

**МКТП(II)-20/2x800(630) – Т56**

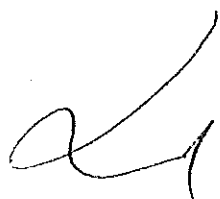

98e

№ по ред	Документ	Приложение № или текст
1.	Точно означение на типа, производителя и страната на производство (произход) и последно издание на каталога на производителя	OPV10S-1 OPV10S-3 OEZ Чехия Приложение 1
2.	Техническо описание и чертежи с нанесени на тях размери	Приложение 1
3.	ЕО декларация за съответствие	Приложение 2
4.	Протоколи от типови изпитвания на английски или български език, проведени от независима изпитвателна лаборатория – заверени копия, с приложен списък на отделните изпитвания на български език	Приложение 3
5.	Сертификат/акредитация на независимата изпитвателна лаборатория, провели типовите изпитвания по т. 4 – заверено копие	Приложение 4

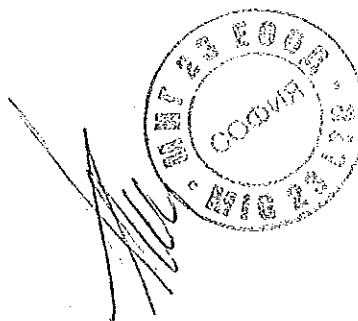
THE INTERNATIONAL CERTIFICATION NETWORK

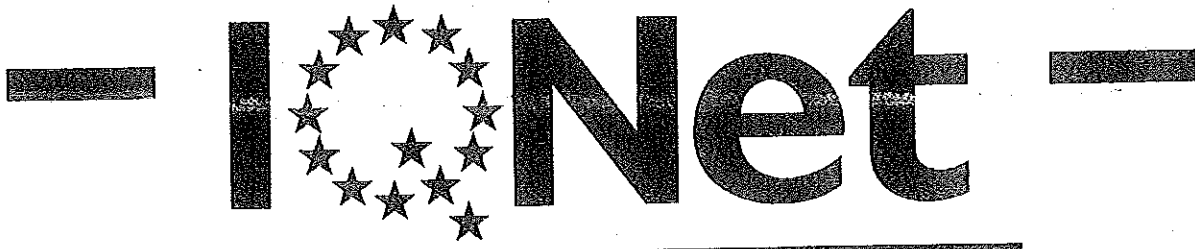
# CERTIFICATE

IQNet and CQS  
hereby certify that the organization

**OEZ s.r.o.**

Šedivská 339, 561 51 Letohrad, Czech Republic

for the following processes

- **Development and Production of Low Voltage Circuit Breakers and Fuses, Tools, Moulds, Special-purpose Machines and Devices**

has implemented and maintains a

**Environmental Management System**

which fulfills the requirements of the following standard

## ISO 14001 : 2004

Issued on: 2013 - 04 - 10  
Validity date: 2016 - 04 - 10

Registration Number: **CZ - 56/2013**

Michael Drechsel  
President of IQNet

Vladimír Filiáč  
President of CQS



**IQNet Partners\*:**

- AENOR Spain AFNOR Certification France AIB-Vincotte International Belgium ANCE Mexico APCER Portugal CCC Cyprus  
 CISQ Italy CQC China CQM China CQS Czech Republic Cro Cert Croatia DQS Holding GmbH Germany DS Denmark  
 ELOT Greece FCAV Brazil FONDONORMA Venezuela ICONTEC Colombia IMNC Mexico INNORPI Tunisia  
 Inspecta Certification Finland IRAM Argentina JQA Japan KFQ Korea MSZT Hungary Nemko AS Norway NSAI Ireland  
 PCBC Poland Quality Austria Austria RR Russia SII Israel SIQ Slovenia SIRIM QAS International Malaysia SQS Switzerland  
 SRAC Romania TEST St Petersburg Russia TSE Turkey YUQS Serbia

IQNet is represented in the USA by: AFNOR Certification, CISQ, DQS Holding GmbH and NSAI Inc.

\* The list of IQNet partners is valid at the time of issue of this certificate. Updated information is available under [www.iqnet-certification.com](http://www.iqnet-certification.com)

**CQS – Asociación para la certificación de sistemas de calidad**  
**Pod Lisem 129, 171 02 Praha 8 - Troja**  
**República Checa**

CQS es órgano de certificación acreditado según la norma EN ISO/IEC 17021:2011 por el Instituto Checo de Acreditación, o. p. s. bajo el número de registración 3029 para la certificación de sistemas de calidad

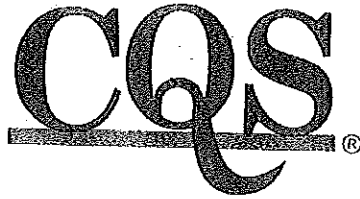

*[Handwritten signature]*

**CERTIFICADO**  
**número: CQS 2085/2013**

CQS – Asociación para la Certificación de Sistemas de Calidad en base del resultado positivo del control de certificación declara que el sistema de calidad

**OEZ s.r.o.**  
**Šedivská 339, 561 51 Letohrad, República Checa**

ha sido revisado y se ha llegado a la conclusión de que dicho sistema cumple los requisitos de

**EN ISO 9001 : 2008**

El presente certificado es válido para las siguientes esferas de producción (servicios):

- **Desarrollo y producción especializados en el ramo de los interruptores y los fusibles de baja tensión así como en herramientas, moldes y máquinas y dispositivos para usos especiales**

*[Handwritten signature]*

\*\*\*\*\*

*[Large handwritten signature]*

**Lubomír Krůta**  
**Subdirector del órgano de certificaciones**

El certificado es válido hasta: 10. 04. 2016  
Resolución de certificación: 10. 04. 2013  
Fecha de expedición: 10. 04. 2013  
Fecha de otorgamiento del primer certificado: 12. 12. 1997



**Miembros de CQS \*:**

Elektrotechnický zkušební ústav, s.p., Fyzikálně technický zkušební ústav, s.p., Institut pro testování a certifikaci, a.s.,  
Strojírenský zkušební ústav, s.p., Technický a zkušební ústav stavební Praha, s.p., Technický a zkušební ústav stavební Praha,  
s.p. – odštěpný závod – ZÚLP, Textilní zkušební ústav, s.p.

\* Lista de los miembros de CQS vigente en el momento de la expedición del certificado. La lista actual está disponible en [www.cqs.cz](http://www.cqs.cz).

*[Handwritten signature]*  
983

## FUSE SWITCH-DISCONNECTORS FOR CYLINDRICAL FUSE-LINKS UP TO 32 A

Fuse switch-disconnectors OPV10 are intended for cylindrical fuse-links PV10 size 10x38. They can safely switch off rated current and overcurrent up to 1.5 rated current and meet the requirements for safe disconnection. Inverse connection is permissible and it affects neither the technical parameters nor the safety of the operator.

- Switch-disconnectors OPV can be sealed in the closed state.
- The devices are designed as modular for 45 mm cutout in the switchboard.
- Optional light indication of fuse state.
- Mounted on „U“ rail of type TH35 according to EN 60715 or on the panel (steel rail recommended).
- Fuse-link state can be indicated by means of electronic signalling, see page D17.

### Fuse switch-disconnectors

Type	Product code	I <sub>n</sub> (A)	Number of poles	Weight (kg)	Package (pcs)
OPV10S-1	38819		1	0.100	12
OPV10-N	38825		N	0.107	12
OPV10S-1N	38820		1+N	0.187	6
OPV10S-2	38821	32	2	0.180	6
OPV10S-3	38822		3	0.280	4
OPV10S-3N	38823		3+N	0.360	3
OPV10S-4	38824		4	0.360	3

<sup>1)</sup> OPV10-N design is without the possibility of signalling of fuse state.

### Accessories

Description	Type	Product code	Weight (kg)	Package (pcs)
Light indication, operating voltage 100 ÷ 500 V a.c., d.c.	S-OPV10	08703	0.002	1
Light indication, operating voltage 12 ÷ 48 V d.c., a.c. (+ pole up)	S-OPV10/48	11812	0.002	1
Light indication, operating voltage 12 ÷ 48 V d.c., a.c. (+ pole down)	S-OPV10/48PD	18234	0.002	1
1-pole interconnecting busbar, cross-section 12 mm <sup>2</sup> , max. current 65 A, rated operating voltage 415 V, max. operating voltage 500 V, length 1 m	G1L-1000-12	37355	0.300	1
2-pole interconnecting busbar, cross-section 16 mm <sup>2</sup> , max. current 80 A, rated operating voltage 415 V, max. operating voltage 500 V, length 1 m	G2L-1000-16	37361	0.477	20
3-pole interconnecting busbar, cross-section 10 mm <sup>2</sup> , max. current 63 A, rated operating voltage 415 V, max. operating voltage 500 V, length 1 m	G3L-1000-10C	37365	0.300	1
End cap, for 1-pole busbars with diameter 10, 12, 16 mm <sup>2</sup>	EKC-1	37383	0.0005	10
End cap, for 3-pole busbars with diameter 10 mm <sup>2</sup>	EKC-3	37385	0.001	10
End cap, for 2-pole and 3-pole busbars with diameter 16 mm <sup>2</sup>	EKC-2+3	37384	0.001	10
Terminal extension, for connection of conductor of cross-section up to 25 mm <sup>2</sup>	AS-25-G	37390	0.012	10
Terminal extension, for connection of Cu/Al conductor of cross-section 2.5 ÷ 50 mm <sup>2</sup>	AS-50-S-AL01	38749	0.02	1
Adapter for busbars with spacing 60 mm, busbar thickness 5 or 10 mm, busbar width 12 ÷ 30 mm, cable outlet bottom, max. current 63 A	GA-60/63/54-1x7,5	11883	0.560	1

### Specifications

Rated operating current	I <sub>n</sub>	32 A
Rated operating voltage (a.c./d.c.)	U <sub>n</sub>	690 V
Utilization category		690 V a.c. AC-21B 250 V d.c. DC-21B 700 V d.c. DC-20B
Rated thermal current with fuse-link	I <sub>th</sub>	
Rated frequency	f <sub>n</sub>	40 ÷ 60 Hz 800 V a.c.
Rated insulation voltage	U <sub>i</sub>	

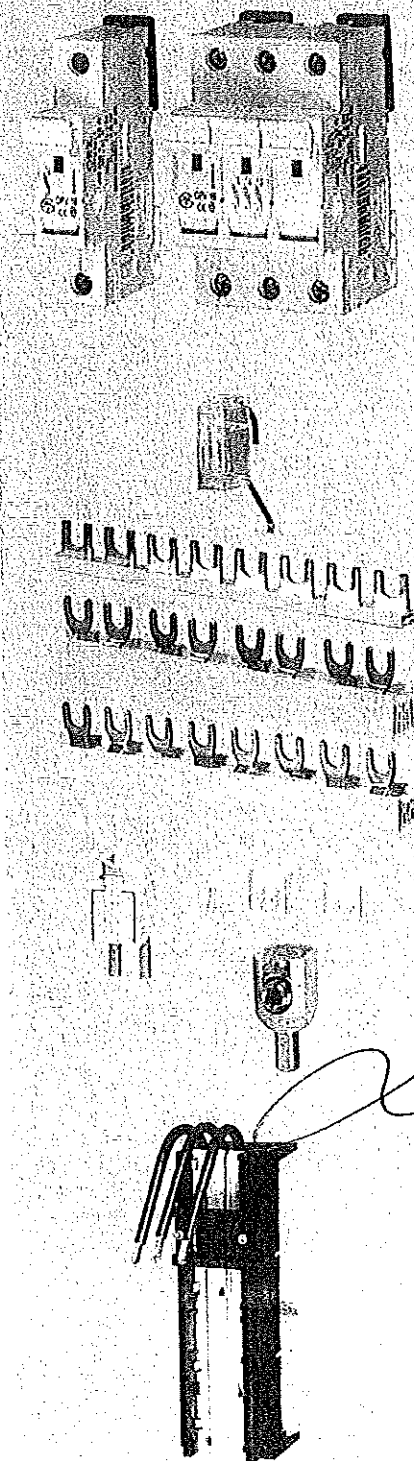

ВЕРНО С  
ОРИГИНАЛА

СЕРТИФИКАТ  
№ 123456789  
01.01.2023

967

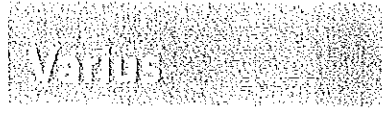

# FUSE SWITCH-DISCONNECTORS FOR CYLINDRICAL FUSE-LINKS UP TO 32 A

## Specifications

Rated conditional short-circuit current with fuse-links PV (RMS)	$I_{sc}$	690 V	110 kA
Rated pulse withstand voltage	$U_{Lsp}$		4 kV
Fuse-link size	diámetro x length		10x38
Max. rated current of the fuse-link	$I_n$		32 A
Max. power losses of the fuse-link**	$P_v$		3.5 W
Rated short-time withstand current	$I_{sw} 1s$		1.6 kA
Rated short-circuit making capacity at 400 V a.c.	$I_{cm}$		4 kA
Electrical endurance			300
Mechanical endurance			1700
Degree of protection, cover closed			IP20
Degree of protection, cover opened			IP20
Connection cross-section			Cu/0.5 + 25 mm <sup>2</sup> (2x 16 mm <sup>2</sup> )
Torque			2 Nm
Operating ambient temperature	t		-25 + +55 °C
Max. sea level			2000 m
Seismic resistance according to VE ŠKODA			3 g/8 ÷ 50 Hz
Overvoltage category/Rated voltage			I (II*)/690 V a.c., II (II*)/500 V a.c., III/400 V a.c.
Standards			IEC 60947-1, -3; EN 60947-1, -3



\* For underground cable distribution systems with overvoltage protection or for exposure to a low thunderstorm electricity (table H2 EN 60947-1, IEC 60947-1).

\*\* Conditions for the use of fuse-links for semiconductor protection PV510 in chapter „Conditions for the use of fuse-links in fuse switch-disconnectors“ see page H33.

EN 60947-3 ed. 2/A2, p. C.5 Instructions for the use of 1-pole controlled devices states:

These devices are intended for distribution systems, with possible necessity of switching and/or safe disconnection of individual phases, and must not be used for switching a primary circuit of a three-phase equipment.

## Reduction of rated current of fuse-links PV gG, aM according to the number of poles

Type	$I_n$ [A]	Reduced rated current [A]				
		(Number of poles)				
		1	3	5	7	10
OPV10	32	32	32	32	32	32

## Neutral pole

		OPV10-N
Rated operating current	$I_n$	32 A
Thermal current with disconnecting link ZPV10	$I_{th}$	110 A/25 mm <sup>2</sup>
Utilization category of the neutral pole at $I_n$		AC-208
Rated short-time withstand current	$I_{sw} 1s$	1.6 kA
Rated short-circuit making capacity at 690 V a.c.	$I_{cm}$ [kA]	5 kA
Rated short-circuit making capacity at 250 V d.c.	$I_{cm}$ [kA]	5.1 kA
Power losses with disconnecting link at $I_n$	$P_v$ [W]	4.8 W
Connection cross-section		0.5 + 25 mm <sup>2</sup>

## Dimensions

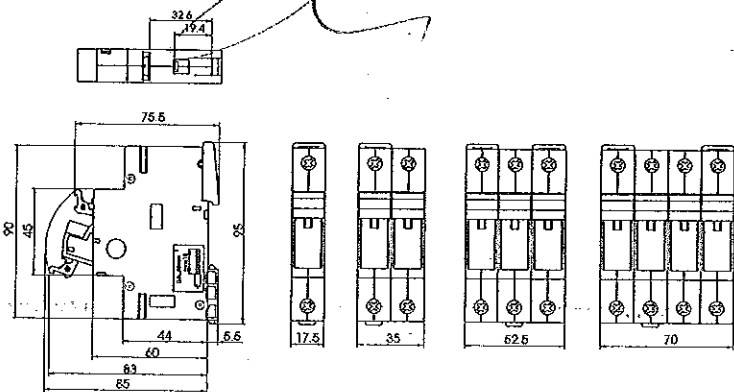

## Diagram

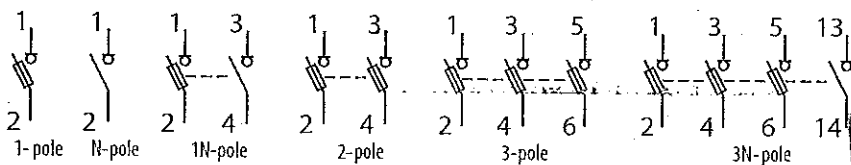

## G1L-1000-12

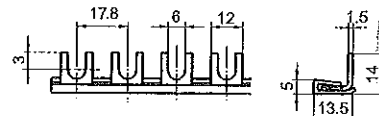

## G2L-1000-16

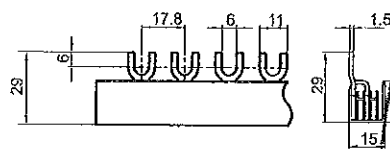

## G3L-1000-10C

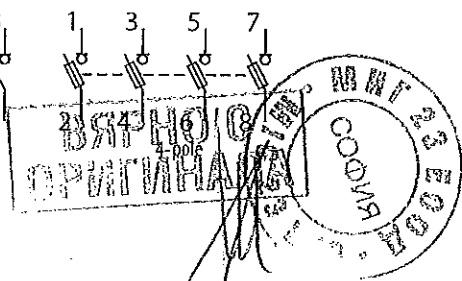
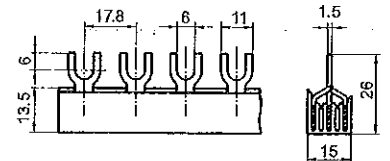

## MINIMAL CONNECTING CROSS-SECTION OF FUSE SWITCH-DISCONNECTORS

Minimal connecting cross-section of cables of fuse switch-disconnectors for cylindrical fuse-links

Fuse-links I <sub>n</sub> (A)	Fuse switch-disconnectors for cylindrical fuse-links			Cable S (mm <sup>2</sup> )	
	OPV10	OPV14	OPV22	Cu	Al
0.25	x	x		1	-
0.5	x	x		1	-
1	x	x		1	-
2	x	x		1	-
4	x	x		1	-
6	x	x		1	-
8	x	x		1	-
10	x	x		1.5	-
12	x	x		1.5	-
16	x	x	x	2.5	-
20	x	x	x	2.5	-
25	x	x	x	4	-
32	x	x	x	4	-
40		x	x	10	-
50		x	x	10	16
63		x	x	16	25
80			x	25	35
100			x	35	50
125			x	50	70

Notes:

- 1) Applies to ambient temperature of switch-disconnectors max. 40 °C
- 2) Applies to HRC fuse-links PV10, PV14, PV22

Minimal connecting cross-section of cables and busbars of fuse switch-disconnectors and fuse rails

Fuse-links I <sub>n</sub> (A)	Fuse switch-disconnectors and fuse rails										Cable S (mm <sup>2</sup> )		Busbar w x h	
	FH000	FH00	FH1	FH2	FH3	FD00 FR00	FD1 FR1	FD2 FR2	FD3 FR3	Cable		Busbar		
										Cu	Al	Cu	Al	
4	x	x				x					1	-	-	-
6	x	x	x			x	x				1	-	-	-
8	x	x	x			x	x				1	-	-	-
10	x	x	x			x	x				1.5	-	-	-
12	x	x	x			x	x				1.5	-	-	-
16	x	x	x			x	x				2.5	-	-	-
20	x	x	x			x	x				2.5	-	-	-
25	x	x	x			x	x				4	-	-	-
32	x	x	x	x		x	x	x			4	-	-	-
35	x	x	x	x		x	x	x			6	-	-	-
40	x	x	x	x		x	x	x			10	-	-	-
50	x	x	x	x		x	x	x			10	16	-	-
63	x	x	x	x		x	x	x			16	25	-	-
80	x	x	x	x	x	x	x	x	x		25	35	-	-
100	x	x	x	x	x	x	x	x	x		35	50	20 x 2	25 x 2
125	x	x	x	x	x	x	x	x	x		50	70	25 x 2	25 x 3
160	x	x	x	x	x	x	x	x	x		70	95	25 x 3	25 x 4
200			x	x	x		x	x	x		95	120	25 x 4	25 x 5
224			x	x	x		x	x	x		95	120	25 x 4	25 x 5
250			x	x	x		x	x	x		120	150	25 x 5	25 x 6
315				x	x			x	x		150	185	32 x 5	32 x 6
350				x	x			x	x		185	240	32 x 6	32 x 8
400				x	x			x	x		240	2x 150	32 x 8	40 x 8
500					x				x		2x 150	2x 185	2x 30 x 5	2x 40 x 5
630					x				x		2x 185	2x 240	2x 40 x 5	2x 40 x 8

Notes:

- 1) Applies to ambient temperature of switch-disconnectors max. 40 °C
- 2) Applies to HRC fuse-links PNA, PHNA

ВЯРНО С  
ОРИГИНАЛА

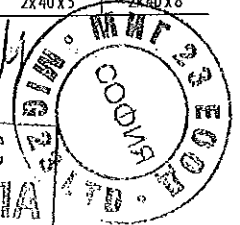



FUSE-LINKS PV

- Small dimensions.
- High limiting and breaking capacity.
- Low power losses.
- The fuse-links do not contain harmful substances according to the RoHS Regulation (cadmium, lead and other).
- Utilization category gG for protection of lines, cables and other equipment against overload and short-circuit.
- Utilization category aM for protection of motors, overcurrent relays, contactors and similar devices only against short-circuit.

Fuse-links PV

(A)	Utilization category gG					Utilization category aM					
	Type	U <sub>n</sub> (V)	Product code	Power losses (W)	Type	U <sub>n</sub> (V)	Product code	Power losses (W)	Weight (kg)	Package (pcs)	
10 x 38	0,25	-	-	-	PV10 0,25A aM	500	06688	0.11	0.011	20	
	0,5	-	-	-	PV10 0,5A aM	500	06689	0.17	0.011	20	
	1	-	-	-	PV10 1A aM	500	06690	0.29	0.011	20	
	2	PV10 2A gG	500	06691	0.72	PV10 2A aM	500	06692	0.92	0.011	20
	4	PV10 4A gG	500	06693	1.17	PV10 4A aM	500	06694	0.25	0.011	20
	6	PV10 6A gG	500	06695	0.88	PV10 6A aM	500	06696	0.31	0.011	20
	8	PV10 8A gG	500	06697	1.04	PV10 8A aM	500	06698	0.46	0.011	20
	10	PV10 10A gG	500	06699	1.29	PV10 10A aM	500	06700	0.46	0.011	20
	12	PV10 12A gG	500	06701	1.48	PV10 12A aM	500	06702	0.47	0.011	20
	16	PV10 16A gG	500	06703	1.86	PV10 16A aM	500	06704	0.67	0.011	20
	20	PV10 20A gG	500	06705	2.20	PV10 20A aM	400	06706	0.87	0.011	20
	25	PV10 25A gG	500	06707	2.58	PV10 25A aM	400	06708	1.05	0.011	20
	32	PV10 32A gG	500	06709	2.54	PV10 32A aM	400	06710	1.50	0.011	20
14 x 51	0,25	-	-	-	PV14 0,25A aM	690	06711	0.12	0.020	10	
	0,5	-	-	-	PV14 0,5A aM	690	06712	0.18	0.020	10	
	1	-	-	-	PV14 1A aM	690	06713	0.30	0.020	10	
	2	PV14 2A gG	690	06714	0.95	PV14 2A aM	690	06715	0.99	0.020	10
	4	PV14 4A gG	690	06716	1.57	PV14 4A aM	690	06717	0.31	0.020	10
	6	PV14 6A gG	690	06718	2.24	PV14 6A aM	690	06719	0.34	0.020	10
	8	PV14 8A gG	690	06720	1.20	PV14 8A aM	690	06721	0.45	0.020	10
	10	PV14 10A gG	690	06722	1.58	PV14 10A aM	690	06723	0.56	0.020	10
	12	PV14 12A gG	690	06724	1.49	PV14 12A aM	690	06725	0.63	0.020	10
	16	PV14 16A gG	690	06726	2.0	PV14 16A aM	500	06727	1.01	0.020	10
	20	PV14 20A gG	690	06728	2.24	PV14 20A aM	500	06729	1.04	0.020	10
	25	PV14 25A gG	690	06730	2.70	PV14 25A aM	500	06731	1.30	0.020	10
	32	PV14 32A gG	690	06732	3.33	PV14 32A aM	500	06733	1.94	0.020	10
22 x 58	40	PV14 40A gG	500	06734	3.86	PV14 40A aM	500	06735	2.04	0.020	10
	50	PV14 50A gG	500	06736	4.10	PV14 50A aM	400	06737	2.91	0.020	10
	63	PV14 63A gG	500	06738	5.35	PV14 63A aM	400	06739	3.69	0.020	10
	16	PV22 16A gG	690	06740	2.23	PV22 16A aM	690	06741	0.92	0.060	10
	20	PV22 20A gG	690	06742	2.24	PV22 20A aM	690	06743	1.06	0.060	10
	25	PV22 25A gG	690	06744	2.90	PV22 25A aM	690	06745	1.43	0.060	10
	32	PV22 32A gG	690	06746	4.10	PV22 32A aM	690	06747	2.03	0.060	10
	40	PV22 40A gG	690	06748	4.52	PV22 40A aM	690	06749	2.50	0.060	10
50	PV22 50A gG	690	06750	6.45	PV22 50A aM	690	06751	2.55	0.060	10	
63	PV22 63A gG	500	06752	5.82	PV22 63A aM	500	06753	4.05	0.060	10	
80	PV22 80A gG	500	06754	6.82	PV22 80A aM	500	06755	4.85	0.060	10	
100	PV22 100A gG	500	06756	7.81	PV22 100A aM	500	06757	5.59	0.060	10	
125	PV22 125A gG	500	18271	10.5	PV22 125A aM	400	06758	6.31	0.060	10	

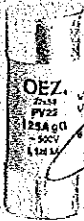

ВЯРНУ  
ОРИГИНАЛ

МНГ 23 ЕОД

968





# FUSE-LINKS PV

## Parameters

Rated voltage	$U_n$	400 ÷ 690 V a.c. 250 V d.c.
Rated breaking capacity (rms)	$I_n$	120 kA/400 ÷ 690 V a.c. (100 kA/PV10 32A gG, 80 kA/PV14 63A gG) 50 kA/250 V d.c.
Utilization category		gG aM
Discrimination		1: 1.6
Standards		IEC 60269 EN 60269

## Approval marks



## Dimensions

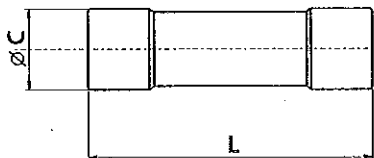

Type	ø C	L
PV10	10.3 ± 0.1	38 ± 0.6
PV14	14.3 ± 0.1	51 <sup>+0.6</sup> <sub>-1</sub>
PV22	22.2 ± 1	58 <sup>+0.1</sup> <sub>-2</sub>

## Characteristics

Prearcing time/current characteristic  
PV10 gG

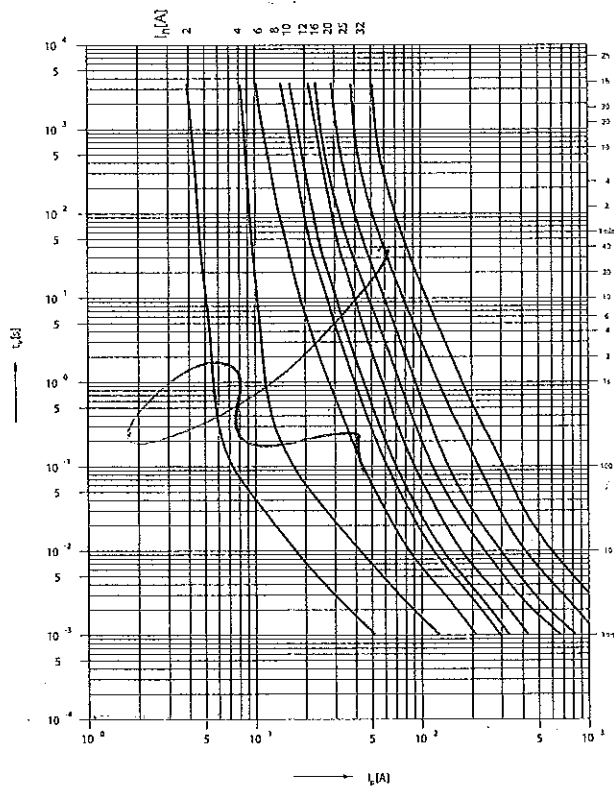

Prearcing time/current characteristic  
PV14 gG

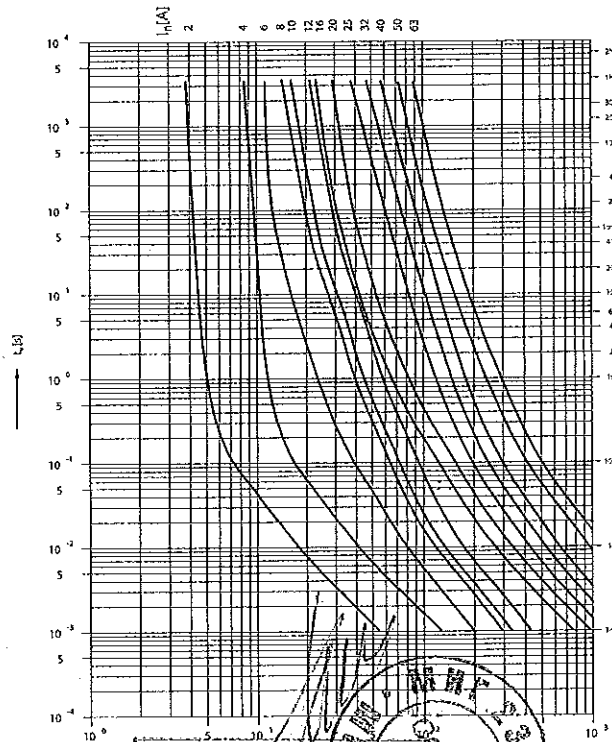

ВЯРНОСТ  
ОРИГИНАЛ

СЕРТИФИКАТ  
ГОДИНА 2008

СЕРИЈА 1000

С.Б.С.

BB

988



### FUSE-LINKS PV

#### Characteristics

Prearcing time/current characteristic  
PV22 gG

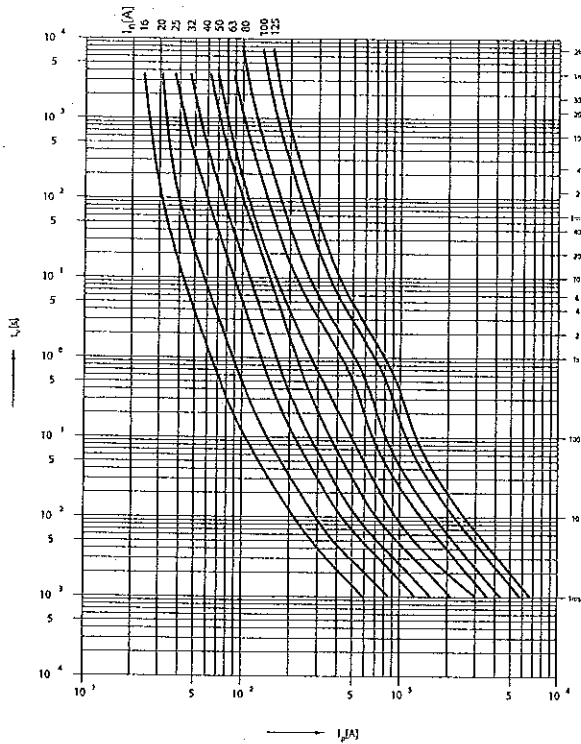

Cut-off characteristic  
PV10, 14, 22 gG pro 500 V a.c.

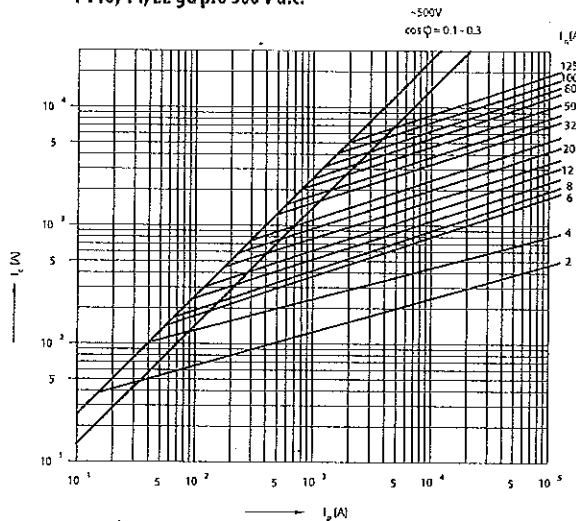

Cut-off characteristic  
PV10, 14, 22 gG pro 690 V a.c.

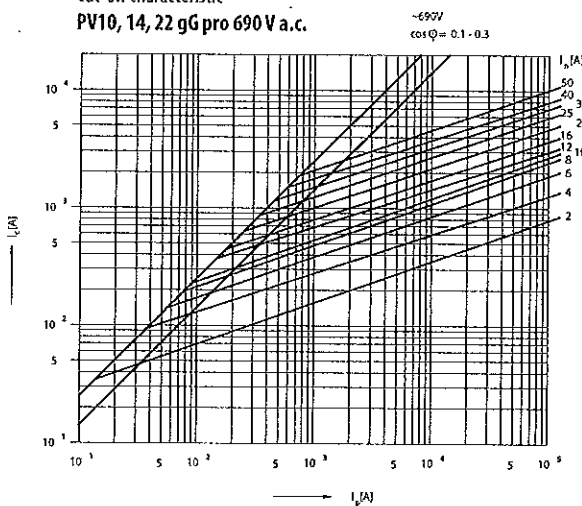

I^2t characteristic  
PV10, 14, 22 gG pro 500 V a.c.

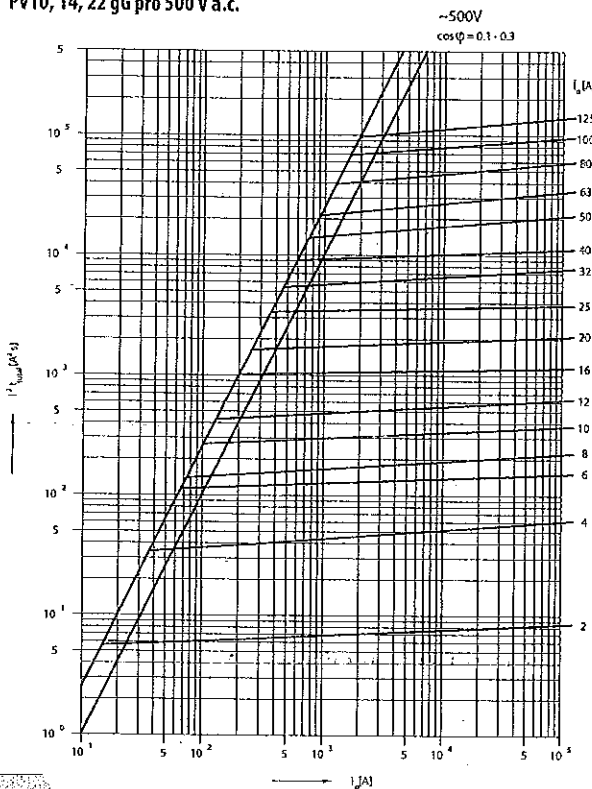

I^2t characteristic  
PV10, 14, 22 gG pro 690 V a.c.

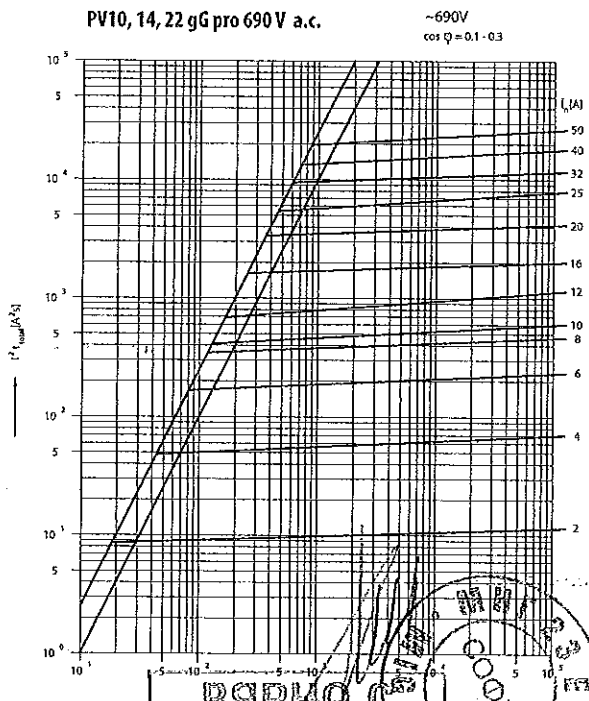

ВАРНО С  
ОРГНИЗАЦИЯ

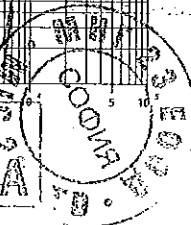

# FUSE-LINKS PV

## Characteristics

Correction factor „k“ of I<sup>2</sup>t dependence on operating voltage U  
 $(I^2 t)_{(U)} = k \times I^2 t_{total}$   
**PV10, 14, 22 aM**

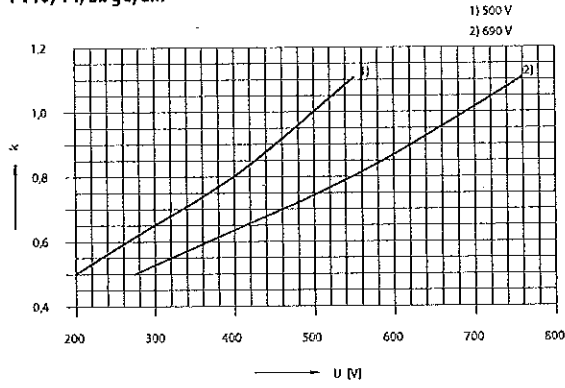

Prearing time/current characteristic  
**PV14 aM**

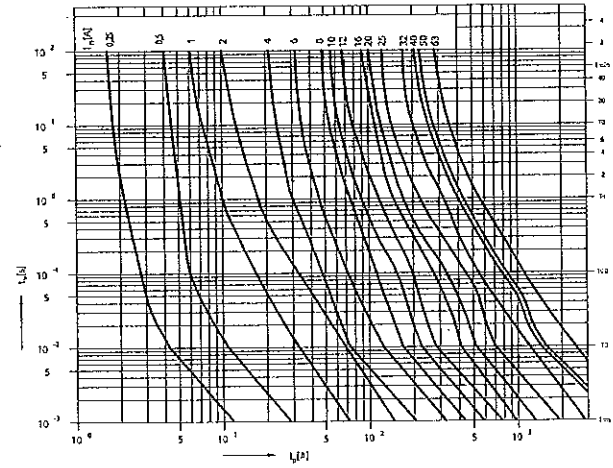

Prearing time/current characteristic  
**PV22 aM**

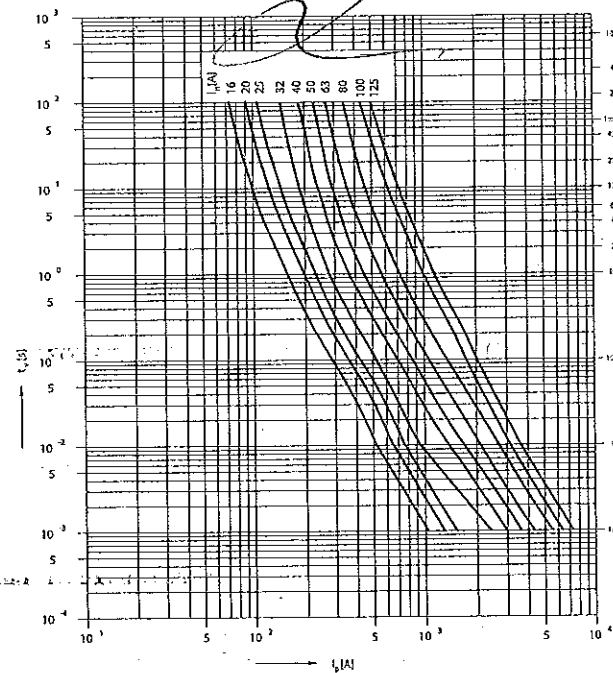

Prearing time/current characteristic  
**PV10 aM**

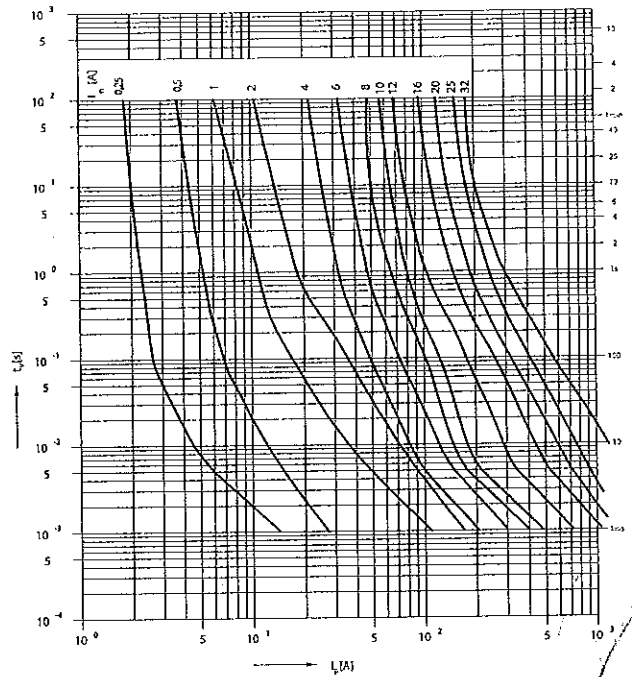

Time/current ranges  
**PV10, 14, 22 aM**

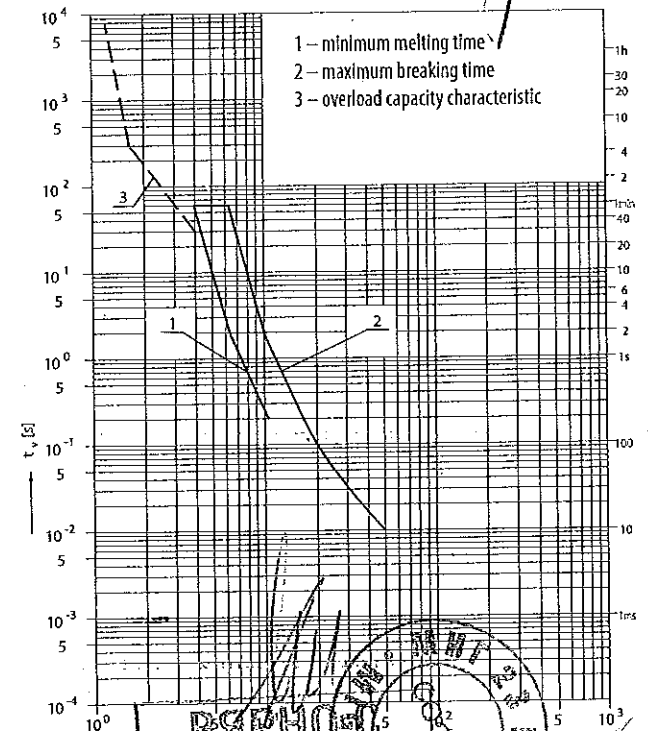

ВЯРНОСТ  
 ОПРИТНА

Handwritten signature and number 970



# FUSE-LINKS PV

## Characteristics

### Cut-off characteristic PV10, 14, 22 aM

PV10 20 ± 32 A for 400 V a.c.    FV22 125 A for 400 V a.c.  
 PV14 50 ± 63 A for 400 V a.c.    FV22 16 ± 50 A for 690 V a.c.  
 PV14 0.25 ± 12 A for 690 V a.c.

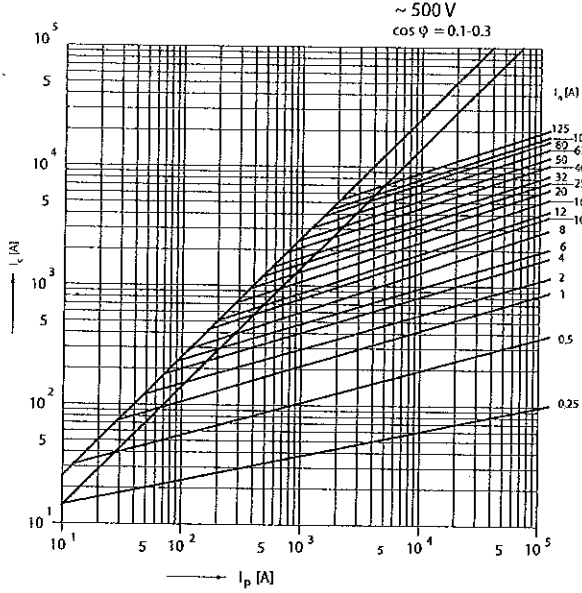

### I<sup>2</sup>t characteristic PV10 aM

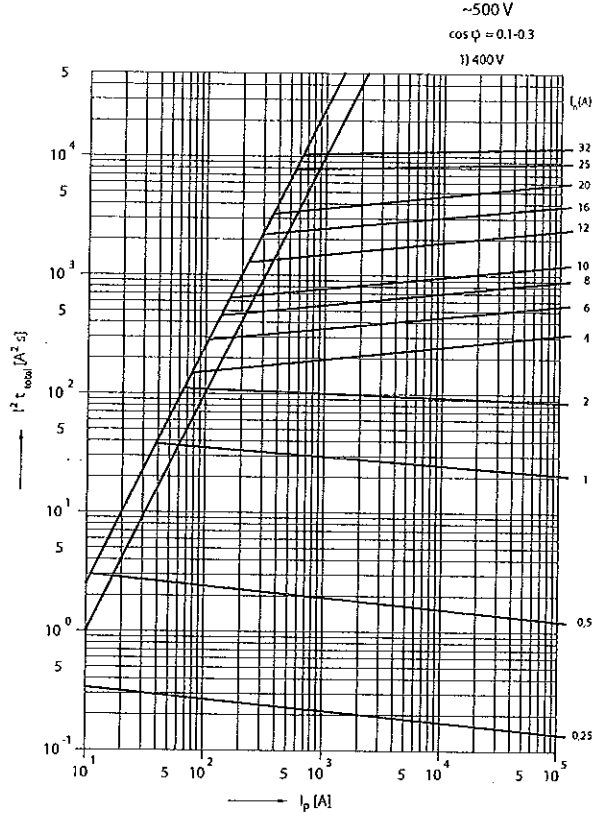

### I<sup>2</sup>t characteristic PV14 aM

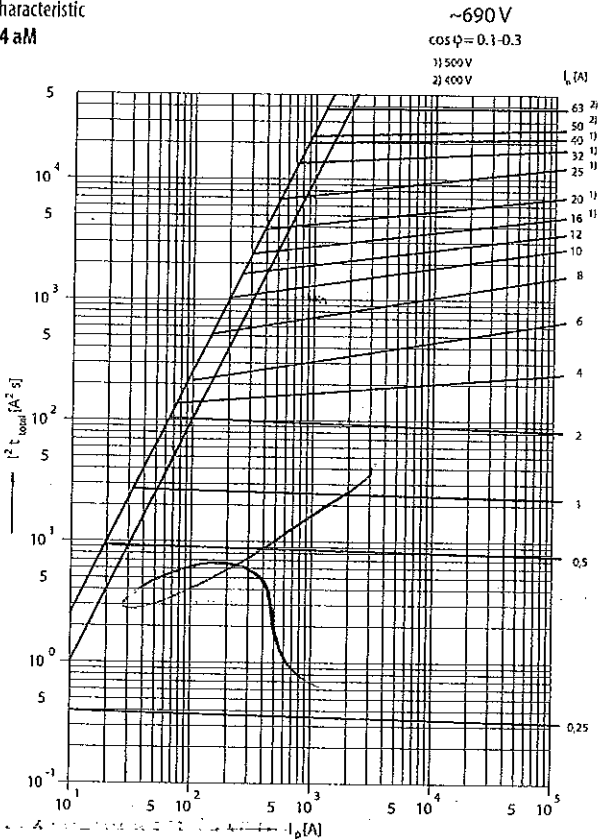

### I<sup>2</sup>t characteristic PV22 aM

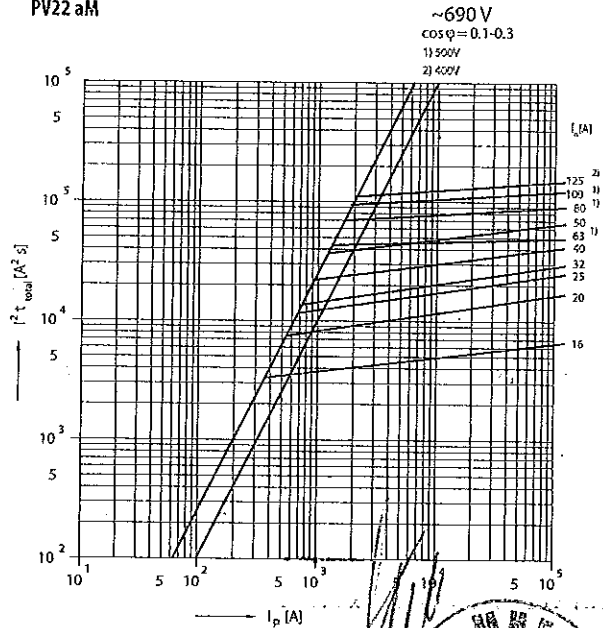

## FUSE SWITCH-DISCONNECTORS OPVP10 UP TO 32 A

- Fuse switch-disconnectors OPVP10 are intended for cylindrical fuse-links size 10x38.
- They can safely switch off rated current and overcurrent. Devices meet the requirements for safe disconnection.
- Inverse connection is permissible and it affects neither the technical parameters nor the safety of the operator.
- Fuse switch-disconnectors OPVP10 can be sealed in the closed state.

- The devices are designed as modular for 45 mm cutout in the switchboard.
- Mounted on „U“ rail of type TH35 according to EN 60715.
- Switch-Disconnector design ...S features LED signalization of the state of fuse-link for each pole.
- Fuse-link state can also be indicated by means of MD-M3 electronic signalling.

### Fuse switch-disconnectors

Type	Order code	I <sub>n</sub> (A)	Number of Poles	Weight (kg)	Package (pcs)
OPVP10-1	OEZ:41013		1	0.063	12
OPVP10-1-S	OEZ:43683		1	0.068	12
OPVP10-1N	OEZ:43686		1+N	0.133	6
OPVP10-2	OEZ:41014	32	2	0.128	6
OPVP10-2-S	OEZ:43684		2	0.137	6
OPVP10-3	OEZ:41015		3	0.193	4
OPVP10-3-S	OEZ:43685		3	0.193	4
OPVP10-3N	OEZ:43687		3+N	0.271	3

### Accessories

Description	Type	Order code	Weight (kg)	Package (pcs)
1-pole interconnecting busbar, cross-section 10 mm <sup>2</sup> , max. current 63 A rated operating voltage AC 690 V / DC 1 000 V, length 210 mm	S1L-210-10	OEZ:38475	0.047	50
1-pole interconnecting busbar, příflez 16 mm <sup>2</sup> , max. current 80 A rated operating voltage AC 690 V / DC 1 000 V, length 1 m	S1L-1000-16	OEZ:37375	0.302	50
2-pole interconnecting busbar, cross-section 10 mm <sup>2</sup> , max. current 63 A rated operating voltage AC 415 V, length 210 mm	S2L-210-10	OEZ:38476	0.110	20
2-pole interconnecting busbar, cross-section 16 mm <sup>2</sup> , max. current 80 A rated operating voltage AC 415 V, length 1 m	S2L-1000-16	OEZ:37378	0.447	20
3-pole interconnecting busbar, cross-section 10 mm <sup>2</sup> , max. current 63 A rated operating voltage AC 415 V, length 210 mm	S3L-210-10	OEZ:38482	0.110	25
3-pole interconnecting busbar, cross-section 16 mm <sup>2</sup> , max. current 80 A rated operating voltage AC 415 V, length 1 m	S3L-1000-16	OEZ:37379	0.737	20
End cap, for single-pole busbars of cross-section 10, 16 mm <sup>2</sup>	EKC-1	OEZ:37383	0.0005	10
End cap, for 2-pole and 3-pole rails 16 mm <sup>2</sup>	EKC-2+3	OEZ:37384	0.001	10
End cap, for 3-pole rails of cross-section 10 mm <sup>2</sup>	EKC-3	OEZ:37385	0.001	10
Terminal extension, with long terminal, cross-section Cu 6 ÷ 50 mm <sup>2</sup>	AL-50-S-L	OEZ:63149	0.033	1
Connection block, enables power supply of interconnecting busbars by conductors of cross-section up to 35 mm <sup>2</sup> , the use of the block extends the mounting with by additional N-poles	ES-35-GS	OEZ:37388	0.03	10
Adapter on „U“ rail TH35, for OPVP10	OD-OPV-AD45	OEZ:43148	0.008	1
Adapter for busbar system with spacing 60 mm, busbar thickness 5 or 10 mm, busbar width 12 ÷ 30 mm, cable outlet bottom, max. current 63 A	GA-60/63/54-1x7,5	OEZ:11883	0.56	1

### Specifications

Rated operating current	I <sub>n</sub>	32 A
Rated operating voltage	U <sub>e</sub>	AC 690 V / DC 440 V
LED signalling voltage range		AC/DC 110 ÷ 690 V
Utilization category		AC 400 V AC-21B
		AC 690 V AC-20B
		DC 250 V DC-21B
Rated thermal current with fuse-link	I <sub>th</sub>	32 A
Rated frequency	f <sub>n</sub>	50 ÷ 60 Hz
Rated insulation voltage	U <sub>i</sub>	AC 800 V
Rated conditional short-circuit current with fuse-links PV (RMS)	I <sub>cc</sub>	AC 400 V 100 kA
		AC 690 V 50 kA
Rated impulse withstand voltage	U <sub>imp</sub>	6 kV
Fuse-link size	diameter x length	10x38
Max. power losses of the fuse-link	P <sub>max</sub>	1.6 kVA
Rated short-time withstand current		3.5 kA
Rated short-circuit making capacity at DC 440 V		



# FUSE SWITCH-DISCONNECTORS OPVP10 UP TO 32 A

## Specifications

Electrical endurance	operating cycles	300
Mechanical endurance	operating cycles	2 000
Degree of protection from front side, built-in device, cover closed		IP20
Connection cross-section		Cu / 0.75 ÷ 25 mm <sup>2</sup> 2x (6 ÷ 16) stranded in the same size
Torque		2 ÷ 2.5 Nm
Operating ambient temperature	t	-25 ÷ +55 °C
Max. sea level		2 000 m
Seismic resistance according to VE ŠKODA		3 g / 8 ÷ 50 Hz
Overvoltage category / Rated voltage		I (II*) / AC 690 V, II (III*) / AC 500 V, III / AC 400 V
Standards		IEC 60947-1, -3; EN 60947-1, -3
Approval marks		

\* For underground cable distribution systems with overvoltage protection or for exposure to a low thunderstorm electricity (table H2 EN 60947-1, IEC 60947-1).

EN 60947-3 ed. 2/A2, p. C.5 Instructions for the use of 1-pole controlled devices states:

These devices are intended for distribution systems, with possible necessity of switching and/or safe disconnection of individual phases, and must not be used for switching a primary circuit of a three-phase equipment.

### Reduction of rated current of fuse-links PV gG, aM according to the number of poles

Type	I <sub>n</sub> [A]	Reduced rated current [A] (number of poles)						
		1	2	3	5	7	10	
OPVP10	32	32	32	32	32	32	32	

### Fuse switch-disconnector with disconnecting link

Rated operating current	I <sub>n</sub>	32 A
Thermal current with disconnecting link ZPV10	I <sub>th</sub>	100 / 25 mm <sup>2</sup>
Utilization category		AC-20B
Rated short-time withstand current	I <sub>cr</sub> 1 s	1.6 kA
Rated short-circuit making capacity	I <sub>cs</sub> AC 690 V	3.5 kA
	I <sub>cs</sub> DC 440 V	4 kA
Power losses with disconnecting link at I <sub>n</sub>	P <sub>v</sub>	4.5 W
Connection cross-section		0.75 ÷ 25 mm <sup>2</sup>

### Diagram

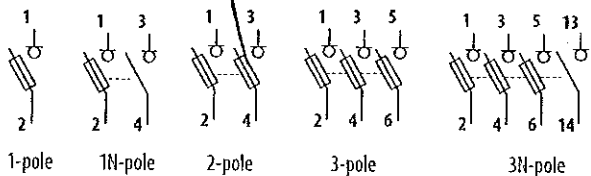

### Interconnecting busbars

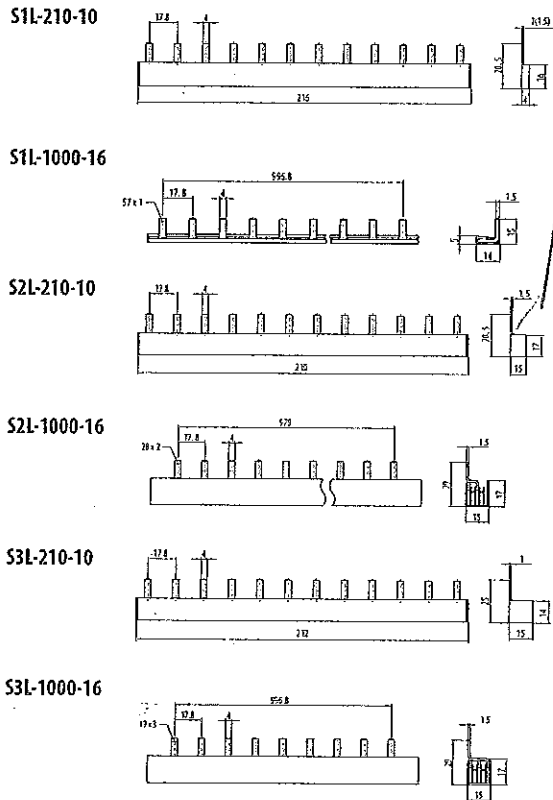

### Dimensions

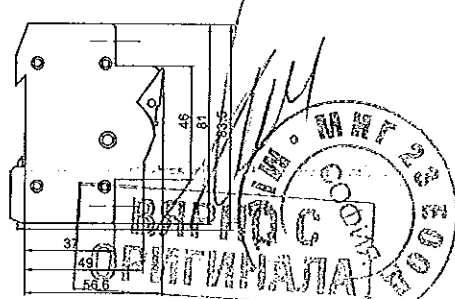
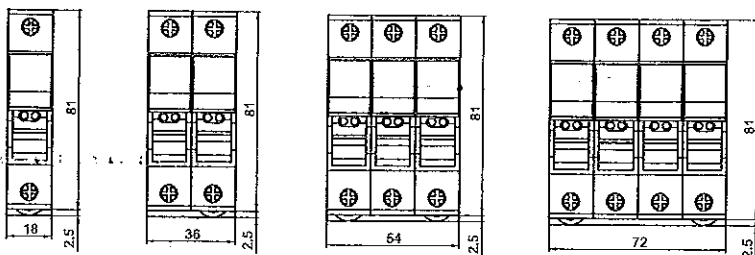

C3  
GTS

# ELEKTROTECHNICKÝ ZKUŠEBNÍ ÚSTAV



ELECTROTECHNICAL TESTING INSTITUTE - CZECH REPUBLIC  
ELEKTROTECHNISCHE PRÜFANSTALT - TSchechISCHE REPUBLIK  
INSTITUT ELECTROTECHNIQUE D'ESSAIS - RÉPUBLIQUE TCHÉQUE  
ЭЛЕКТРОТЕХНИЧЕСКИЙ ИСПЫТАТЕЛЬНЫЙ ИНСТИТУТ - ЧЕШСКАЯ РЕСПУБЛИКА

Pod Lisem 129, 171 02 Praha 8 - Troja

## CERTIFICATE

No.: 1140839

Product: Fuse-disconnector

Type: OPVP10, 14, 22

Rating: 32 A, 50 A, 100 A; 690 V AC, 440 V DC

Ordering firm: OEZ s. r. o.  
Šedivská 339, 561 51 Letohrad, Czech Republic

Manufacturer: OEZ s. r. o.  
Šedivská 339, 561 51 Letohrad, Czech Republic

Trade mark:

The test results are stated in the test-report No.: 403929-01/01 of: 30.09.2014

A sample of the product was found to be in conformity with:  
ČSN EN 60947-3 ed. 3:10+A1:12, ČSN EN 60947-1 ed.4:08+A1:11

The validity of the certificate is limited to: 31.10.2017

7.10.2014

Prague

Miroslav Sedláček  
Head of Certification Body



403929-01

# ELEKTROTECHNICKÝ ZKUŠEBNÍ ÚSTAV



ELECTROTECHNICAL TESTING INSTITUTE - CZECH REPUBLIC  
ELEKTROTECHNISCHE PRÜFANSTALT - TSCHIECHISCHE REPUBLIK  
INSTITUT ELECTROTECHNIQUE D'ESSAIS - RÉPUBLIQUE TCHÈQUE  
ЭЛЕКТРОТЕХНИЧЕСКИЙ ИСПЫТАТЕЛЬНЫЙ ИНСТИТУТ - ЧЕШСКАЯ РЕСПУБЛИКА

Pod Lisem 129, 171 02 Praha 8 - Troja

## CERTIFICATE

No.: 1120754

Product: Fuse switch-disconnector

Type: OPVA10,14,22 / OPVP10,14,22  
(variants see enclosure)

Rating: 32 A, 50 A, 100 A for OPVA; 32 A, 63 A, 125 A for OPVP; 690 V AC, 440 V DC

Ordering firm: OEZ s. r. o.  
Šedivská 339, 561 51 Letohrad, Czech Republic

Manufacturer: Wöhner GmbH & Co. KG  
Münchendorfer Strasse 10, D-96472 Rödental, Germany

Trade mark:

The test results are stated in the test-report No.: 204265-01/01 of: 21.09.2012

A sample of the product was found to be in conformity with:  
ČSN EN 60947-3 ed.3:10, ČSN EN 60947-1 ed.4:08+A1:11

The validity of the certificate is limited to: 30.9.2015

26.9.2012

Prague

Miroslav Sedláček  
Head of Certification Body

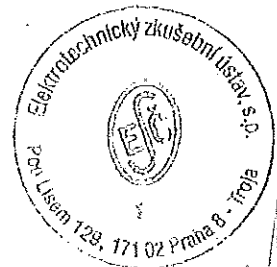

575



marking	type design
OPVA10-1	1-pól
OPVA10-1N	1+N pól
OPVA10-2	2-pól
OPVA10-3	3-pól
OPVA10-3N	3+N pól
OPVA14-1	1-pól
OPVA14-1N	1+N pól
OPVA14-2	2-pól
OPVA14-3	3-pól
OPVA14-3N	3+N pól
OPVA22-1	1-pól
OPVA22-1N	1+N pól
OPVA22-2	2-pól
OPVA22-3	3-pól
OPVA22-3N	3+N pól
OPVA10-1-S	1-pól+signal.
OPVA10-2-S	2-pól+signal.
OPVA10-3-S	3-pól+signal.
OPVA14-1-S	1-pól+signal.
OPVA14-2-S	2-pól+signal.
OPVA14-3-S	3-pól+signal.
OPVA22-1-S	1-pól+signal.
OPVA22-2-S	2-pól+signal.
OPVA22-3-S	3-pól+signal.
OPVP10-1	1-pól
OPVP10-2	2-pól
OPVP10-3	3-pól
OPVP14-1	1-pól
OPVP14-2	2-pól
OPVP14-3	3-pól
OPVP22-1	1-pól
OPVP22-2	2-pól
OPVP22-3	3-pól

*[Handwritten mark]*

*[Handwritten mark]*

*[Handwritten signature]*

*[Handwritten signature]*



*[Handwritten signature]*



**ES PROHLÁŠENÍ O SHODĚ / CE DECLARATION OF CONFORMITY**  
**EU PROHLÁŠENÍ O SHODĚ / EU DECLARATION OF CONFORMITY**

Číslo / No.: 503002/1412

My / We, **OEZ s.r.o.**  
 Šedivská 339, 561 51 Letohrad, Česká republika

prohlašujeme na svou výlučnou odpovědnost, že  
 declare on our own responsibility that

Výrobek: Odpínače válcových pojistek velikosti 10x38  
 Product: Fuse switch-disconnectors for cylindrical fuse-links size 10x38

Typ / Type: OPVP10

Příslušenství / Accessory:

Je ve shodě s následujícími normami:  
 complies with the following standards:

České normy / Czech standards	Evropské normy / European standards
ČSN EN 60947-1:08ed.4 +A1:11	EN 60947-1:07
ČSN EN 60947-3:10ed.3+A1:12	EN 60947-3:09

a následujícími nařízeními vlády, ve znění pozdějších předpisů (NV)  
 and the following government regulations (NV), as amended

NV 17/2003 Sb. v platném znění NV 481/2012 Sb. v platném znění	2006/95/ES - including amendments 2011/65/EU - including amendments
---	--

Elektrotechnický zkušební ústav, Pod Lisem 129, 171 02 Praha 71, Česká republika  
 zkoušel / certifikoval daný výrobek a vydal:  
 tested / certified the product and issued:

EZU Certifikát / EZU Certificate: 1140839 ze dne 7.10.2014  
 EZU zkušební protokol / EZU test report: 403929-01/01 ze dne 30.09.2014

Poslední dvojčíslí roku, v němž bylo označení CE na výrobek umístěno: 14  
 Last two digits of the year in which the CE mark was placed on the product:

Místo vydání: Letohrad  
 Place of issue:  
 signature:

Zástupce výrobce a podpis: Ing. Roman Schiffer  
 Manufacturer's representative and

Datum vydání: 04.12.2014  
 Date of issue:

Funkce: generální ředitel  
 Position: general director

**OEZ**  
 OEZ s.r.o.  
 Šedivská 339, Letohrad 561 51  
 Česká republika  
 IČO: 49810146, DIČ: CZ49810146



*[Handwritten signature]*

*[Large handwritten signature]*

*[Handwritten signature]*

*[Handwritten signature]*

*[Handwritten signature]*

Превод от чешки език

CE Декларация за съответствие на  
Cislo / No.: 209706/1407  
Hne / Hne, OEZ s.r.o.

Šedivská 339, 561 51 Letohrad, Чехия

Декларирам, на нашата собствена отговорност, че

Продукт: На разединители за цилиндрични предпазители размер 10x38

Продукт: Fuse преминаване sdisconnectors за цилиндрични предпазител-връзки размер 10x38

Вид / Тип: OPVP10 Prfslusenstvf / аксесоари:

Тя е в съответствие със следните стандарти:

отговаря на стандарти:

Чешките стандарти / Чешките стандарти на европейските стандарти / Европейски стандарти  
EN 60947-1: 08ed.4 + A1: 11 CSN EN 60947-3: 10ed.3 + A1: 12 EN 60947-1: 07 EN 60947-3: 09  
и след nařizeními правителство, както е изменена (NV) и Правилника за държавен seuraavilla (NV),  
както е изменен  
NV 17/2003 Coll. както е изменен, NV 481/2012 Coll. изменена 2006/95 / EO - включително изменения  
2011/65 / EC - включително изменения

EZU, Pod Lisem 129, 171 02 Prague 71, Чешка република опитан / сертифициран продукт и издава:

тестван / сертифициран продукт и издава:

EZU Сертификат / Удостоверение EZU: 1140839 с дата 07.10.2014

/ Доклад за тест EZU тест протокол EZU: 403929-01 / 01 от 30 септември 2014

Последните две цифри на годината, в която маркировка CE: 14

Последните две цифри на годината, през която маркировката се поставя обект на продукта:

Място на издаване: Letohrad

Място на издаване:

подпис:

Дата на издаване: 04 Декември 2014





Ref. Certif. No.

DE1-49452

IEC SYSTEM FOR MUTUAL RECOGNITION OF TEST CERTIFICATES FOR ELECTRICAL EQUIPMENT (IECEE) CB SCHEME

SYSTEME CEI D'ACCEPTATION MUTUELLE DE CERTIFICATS D'ESSAIS DES EQUIPEMENTS ELECTRIQUES (IECEE) METHODE OC

CB TEST CERTIFICATE CERTIFICAT D'ESSAI OC

Product  
Produit

Fuse-switch-disconnector

Name and address of the applicant  
Nom et adresse du demandeur

Wöhner GmbH & Co. KG Elektrotechnische Systeme  
Mönchrödener Straße 10, 96472 Rödental  
GERMANY

Name and address of the manufacturer  
Nom et adresse du fabricant

Wöhner GmbH & Co. KG Elektrotechnische Systeme  
Mönchrödener Straße 10, 96472 Rödental  
GERMANY

Name and address of the factory  
Nom et adresse de l'usine

Wöhner GmbH & Co. KG Elektrotechnische Systeme  
Mönchrödener Straße 10, 96472 Rödental  
GERMANY

Note: When more than one factory, please report on page 2  
Note: Lorsque il y plus d'une usine, veuillez utiliser la 2<sup>ème</sup> page

Ratings and principal characteristics  
Valeurs nominales et caractéristiques principales

Additional Information on page 2  
Utilization category: AC-21B, AC-22B  
Rated voltage: 400 V, 500 V, 690 V a.c.  
Rated current: 10 A, 25 A, 32 A

**wöhner**

Trademark (if any)  
Marque de fabrique (si elle existe)

Type of Manufacturer's Testing Laboratories used  
Type de programme du laboratoire d'essais constructeur

Model / Type Ref.  
Ref. De type

AES 10x38

Additional information (if necessary may also be reported on page 2)  
Les informations complémentaires (si nécessaire, peuvent être indiqués sur la 2<sup>ème</sup> page)

Numbers of poles: 1/2/3-pol. and 1/3-pol.+Neutral

Additional Information on page 2

PUBLICATION

EDITION

A sample of the product was tested and found to be in conformity with  
Un échantillon de ce produit a été essayé et a été considéré conforme à la

IEC 60947-1(ed.5);am1:2010-12  
IEC 60947-3(ed.3)

As shown in the Test Report Ref. No. which forms part of this Certificate  
Comme indiqué dans le Rapport d'essais numéro de référence qui constitue partie de ce Certificat

249800-4402-0705/152633

This CB Test Certificate is issued by the National Certification Body  
Ce Certificat d'essai OC est établi par l'Organisme National de Certification

VDE Prüf- und Zertifizierungsinstitut GmbH  
VDE Testing and Certification Institute  
Zertifizierungsstelle / Certification

*Handwritten signature: J. B. Bensch*

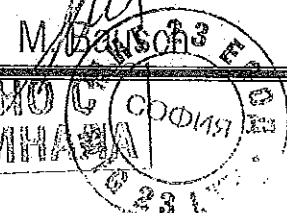

Date: 2011-12-13

Signature:



979

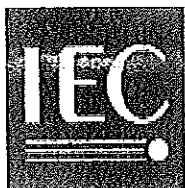

Test Report issued under the responsibility of:



TEST REPORT IEC 60947-3 Low-voltage switchgear and controlgear Part 3: Switches, disconnectors, switch-disconnectors and fuse-combination units	
Report Reference No. ....	249800-4402-0705/152633
Date of issue.....	2011-12-12
Total number of pages .....	116
CB Testing Laboratory.....	VDE Prüf- und Zertifizierungsinstitut GmbH VDE Testing and Certification Institute
Address .....	Merianstraße 28 · 63069 Offenbach , Germany
Applicant's name.....	Wöhner GmbH & Co. KG Elektrotechnische Systeme
Address .....	Mönchrödener Straße 10, 96472 Rödental, Germany
<b>Test specification:</b>	
Standard .....	IEC 60947-3: 3 <sup>rd</sup> Edition (2008) in conjunction with IEC 60947-1: 5 <sup>th</sup> Edition (2007)
Test procedure .....	CB
Non-standard test method.....	N/A
Test Report Form No. ....	IEC60947_3B
Test Report Form(s) Originator .....	OVE
Master TRF .....	Dated 2009-08
<p><b>Copyright © 2009 Worldwide System for Conformity Testing and Certification of Electrical Equipment and Components (IECEE), Geneva, Switzerland. All rights reserved.</b></p> <p>This publication may be reproduced in whole or in part for non-commercial purposes as long as the IECEE is acknowledged as copyright owner and source of the material. IECEE takes no responsibility for and will not assume liability for damages resulting from the reader's interpretation of the reproduced material due to its placement and context.</p> <p>If this Test Report Form is used by non-IECEE members, the IECEE/IEC logo and the reference to the CB Scheme procedure shall be removed.</p> <p><b>This report is not valid as a CB Test Report unless signed by an approved CB Testing Laboratory and appended to a CB Test Certificate issued by an NCB in accordance with IECEE 02.</b></p>	
Test item description .....	Fuse-switch-disconnector
Trade Mark .....	<b>wöhner</b>
Manufacturer .....	Wöhner GmbH & Co. KG Elektrotechnische Systeme
Model/Type reference.....	AES 10x38
Ratings .....	See page 6 and 7

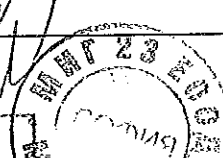

Handwritten signature and number 980

<b>Testing procedure and testing location:</b>	
<input checked="" type="checkbox"/> <b>CB Testing Laboratory:</b>	<b>VDE Prüf- und Zertifizierungsinstitut GmbH</b> VDE Testing and Certification Institute
Testing location/ address .....	Merianstraße 28 , 63069 Offenbach , Germany
<input checked="" type="checkbox"/> <b>Associated CB Test Laboratory:</b>	<b>IPH Institut "Prüffeld für elektrische Hochleistungstechnik" GmbH</b>
Testing location/ address .....	Landsberger Allee 378 A , 12681 Berlin , Germany
Tested by (name + signature) .....	H. Schmidt <i>H. Schmidt</i>
Approved by (+ signature) .....	T. Kohushölter <i>T. Kohushölter</i>
<input type="checkbox"/> Testing procedure: TMP	
Testing location/ address .....	
Tested by (name + signature) .....	
Approved by (+ signature) .....	
<input type="checkbox"/> Testing procedure: WMT	
Testing location/ address .....	
Tested by (name + signature) .....	
Witnessed by (+ signature) .....	
Approved by (+ signature) .....	
<input type="checkbox"/> Testing procedure: SMT	
Testing location/ address .....	
Tested by (name + signature) .....	
Approved by (+ signature) .....	
Supervised by (+ signature) .....	
<input type="checkbox"/> Testing procedure: RMT	
Testing location/ address .....	
Tested by (name + signature) .....	
Approved by (+ signature) .....	
Supervised by (+ signature) .....	



**Summary of testing:**

The tests are carried-out according to IEC 60947-1 (ed.5);am1:2010-12 and IEC 60947-3 (ed.3).

**Tests performed (name of test and test clause):****Testing location:****Clause 7.1 (Construction) .....****VDE Testing and Certification Institute****Test sequence I: .....****IPH Institut**

Sample No.1: AC-21B, 500 V, 25 A, 1-pole

see page 16 - 20

Sample No.2: AC-21B, 690 V, 10 A, 1-pole

see page 21 - 25

Sample No.3: AC-22B, 400 V, 32 A, 1-pole

see page 26 - 30

Sample No.4: AC-22B, 400 V, 32 A, 2-pole

see page 31 - 35

Sample No.5: AC-22B, 500 V, 25 A, 2-pole

see page 36 - 40

Sample No.6: AC-22B, 690 V, 10 A, 2-pole

see page 41 - 45

Sample No.7: AC-22B, 690 V, 32 A, 3-pole+N

see page 46 - 50

**Test sequence II: .....****IPH Institut**

Sample No.8: AC-21B, 500 V, 25 A, 1-pole

see page 51 - 52

Sample No.9: AC-21B, 690 V, 10 A, 1-pole

see page 53 - 54

Sample No.10: AC-22B, 400 V, 32 A, 1-pole

see page 55 - 56

Sample No.11: AC-22B, 400 V, 32 A, 2-pole

see page 57 - 58

Sample No.12: AC-22B, 500 V, 25 A, 2-pole

see page 59 - 60

Sample No.13: AC-22B, 690 V, 10 A, 2-pole

see page 61 - 62

Sample No.14: AC-22B, 690 V, 32 A, 3-pole+N

see page 63 - 64

**Test sequence IV: .....****IPH Institut**Sample No.15: 400 V a.c., 100 kA, 1-pole  
(with fuse-link 32 A / 400 V)

see page 68 - 69

Sample No.16: 400 V a.c., 100 kA, 1-pole+N  
(with fuse-link 32 A / 400 V)

see page 70 - 71

Sample No.17: 400 V a.c., 100 kA, 2-pole  
(with fuse-link 32 A / 400 V)

see page 72 - 73

Sample No.18: 400 V a.c., 100 kA, 3-pole+N  
(with fuse-link 32 A / 400 V)

see page 74 - 75



**Summary of testing: (Continuation)**

The tests are carried-out according to IEC 60947-1 (ed.5);am1:2010-12 and IEC 60947-3 (ed.3).

**Tests performed (name of test and test clause):**

**Testing location:**

**Test sequence IV: .....**

**IPH Institut**

Sample No.19: 500 V a.c., 100 kA, 1-pole  
(with fuse-link 25 A / 500 V)

see page 76 - 77

Sample No.20: 500 V a.c., 100 kA, 1-pole+N  
(with fuse-link 25 A / 500 V)

see page 78 - 79

Sample No.21: 500 V a.c., 100 kA, 2-pole  
(with fuse-link 25 A / 500 V)

see page 80 - 81

Sample No.22: 500 V a.c., 100 kA, 3-pole+N  
(with fuse-link 25 A / 500 V)

see page 82 - 83

Sample No.23: 690 V a.c., 50 kA, 1-pole  
(with fuse-link 10 A / 690 V)

see page 84 - 85

Sample No.24: 690 V a.c., 50 kA, 1-pole+N  
(with fuse-link 10 A / 690 V)

see page 86 - 87

Sample No.25: 690 V a.c., 50 kA, 2-pole  
(with fuse-link 10 A / 690 V)

see page 88 - 89

Sample No.26: 690 V a.c., 50 kA, 3-pole+N  
(with fuse-link 32 A / 400 V)

see page 90 - 91

**Test sequence V: .....**

**IPH Institut**

Sample No.27: 690 V, 32 A, 1-pole  
(with fuse-link 32 A / 400 V)

see page 92 - 93

Sample No.28: 690 V, 32 A, 2-pole  
(with fuse-link 32 A / 400 V)

see page 94 - 95

Sample No.29: 690 V, 32 A, 3-pole+N  
(with fuse-link 32 A / 400 V)

see page 96 - 97

**Summary of compliance with National Differences:**

**Not applicable**



Handwritten initials 'JOS' at the bottom right of the page.



Copy of marking plate

Front printing: (for example a single pole device)

# wöhner

AES10x38  
32A 10x38  
31 110 1P

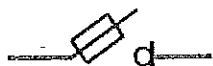

Side printing:

IEC 60947-3 AC-22B 32A 400V 50/60Hz Ui:AC800V

 <b>30A 600V</b> Do not operate under load	gG	32A	6 □	3.0W
	aM	32A	6 □	1.2W
	aR/gR	consult		

gG	32A	6 □	3.0W
aM	32A	6 □	1.2W
aR/gR	consult		

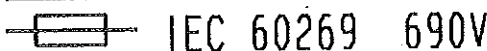

IEC 60269 690V

18...4AWG  
0.75...25mm<sup>2</sup>

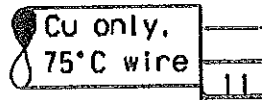

PZ2 2.5Nm  
22lb-in

When two conductors per terminal are used, only stranded wires of the same size within the range of 18-6AWG, may be used

Picture of the fuse-switch-disconnector: (for example a single pole device)

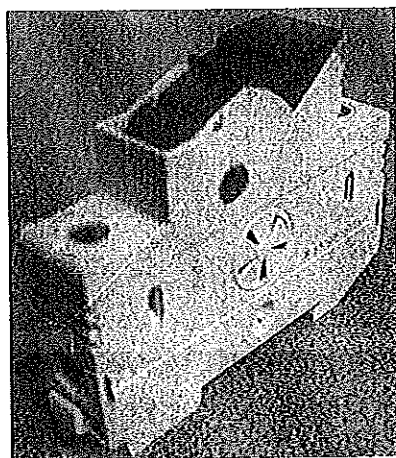

TRF No. IEC60947\_3B

ВЯРНО С  
ОРИГИНАЛАТ

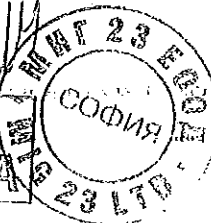

*[Handwritten signature]*

**Test item particulars** .....

- method of operation .....: Dependent manual operation
- suitability for isolation .....: Suitable / not suitable
- degree of protection .....: IP20
- number of poles.....: 1; 2; 3; 1+N; 3+N
- kind of current.....: a.c.
- number of positions of the main contacts.....: 2 (open and closed)

Rated and limiting values, main circuit:

- rated operational voltage  $U_e$  (V) .....: 400 V a.c.  
500 V a.c.  
690 V a.c.
- rated insulation voltage  $U_i$  (V) .....: 800 V
- rated impulse withstand voltage  $U_{imp}$  (kV) .....: 6 kV
- conventional free air thermal current  $I_{th}$  (A) .....: 32 A
- conventional enclosed thermal current  $I_{the}$  (A) .....: —
- rated operational current  $I_e$  (A) .....: See utilization category
- rated uninterrupted current  $I_u$  (A).....: See utilization category
- rated frequency (Hz).....: 50/60 Hz
- utilization category.....:

	$U_e$ [V]	$I_e$ [A]	Number of poles
AC-21B	500	25 <sup>*)</sup>	1; 1+N
	690	10 <sup>*)</sup>	1; 1+N
AC-22B	400	32 <sup>*)</sup>	1; 2; 3; 1+N; 3+N
		25 <sup>*)</sup>	2; 3; 3+N
	500	32 <sup>*)</sup>	3; 3+N
		10 <sup>*)</sup>	2
690	32 <sup>*)</sup>	3; 3+N	

<sup>\*)</sup> Corresponding short circuit current: 50 kA  
<sup>\*\*)</sup> Corresponding short circuit current: 100 kA

Short-circuit characteristic:

- rated short-time withstand current  $I_{cw}$  (kA) .....: —
- rated short-time making capacity  $I_{cm}$  (kA) .....: —
- rated conditional short-circuit current.....: 50 kA; 100 kA (See utilization category)

Control circuits.....: —

Auxiliary circuits.....: —

Relays and releases.....: —

ВЯРНО С  
ОРИГИНАЛА

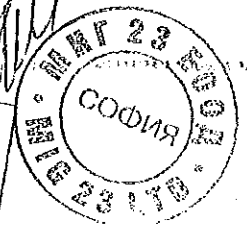

*[Handwritten signature]*

<b>Co-ordination of short-circuit protective devices:</b>	
- kind of protective device.....	Fuse-links with cylindrical contact caps for fuse system F (size 10,3 x 38) Rated currents: 10 A (gR), 25 A (gG) and 32 A (gG)
<b>Possible test case verdicts:</b>	
- test case does not apply to the test object.....	N/A
- test object does meet the requirement .....	P (Pass)
- test object does not meet the requirement .....	F (Fail)
<b>Testing .....</b>	
Date of receipt of test item .....	2011-06
Date (s) of performance of tests .....	2011-06 up to 2011-11

<b>General remarks:</b>
The test results presented in this report relate only to the object tested. This report shall not be reproduced, except in full, without the written approval of the Issuing testing laboratory.  "(see Enclosure #)" refers to additional information appended to the report. "(see appended table)" refers to a table appended to the report.  Throughout this report a comma (point) is used as the decimal separator.
<b>General product information:</b>
The fuse-switch-disconnectors of type AES10x38 are available for DIN-rail mounting with cable connection on the line and load side.  The cable connection is possible by screw terminals (box terminal connection). The box terminal connection is suitable for cable cross-sections between 0,75mm <sup>2</sup> and 25mm <sup>2</sup> .  <b>Upon the tests of the making and breaking capacities and the performance under short-circuit conditions the distances between the metallic screen and the test items were 0 mm to the sides and 0 mm to the top.</b>

TRF No. IEC60947\_3B



Handwritten signature and the number 306.

IEC 60947-3			
Clause	Requirement + Test	Result - Remark	Verdict
5.2	MARKING		P
	Marking on equipment itself or on nameplate or nameplates attached to the equipment and legible from the front after mounting		—
	- indication of the open and closed position		P
	- suitability for isolation		P
	- disconnectors AC-20 and DC-20 only: marked "Do not operate under load"		N/A
	Marking on equipment not needed to be visible after mounting:		—
	- manufacturer's name or trademark	<b>wöhner</b>	P
	- type designation or serial number	AES 10x38	P
	- rated operational currents	10 A, 25 A, 32 A	P
	- rated operational voltage	400 V, 500 V, 690 V a.c.	P
	- utilization category	See page 6	P
	- rated frequency	50/60 Hz	P
	- manufacturer's claim for compliance with IEC 60947-3		P
	- degree of protection	IP20	P
	Marking on fuse-combination units:		—
	- fuse type	Fuse System F (size 10,3x38)	P
	- maximum rated current	32 A	P
	- power loss of the fuse-link	< 3 W	P
	Identification of terminals:		—
	- line terminals, unless connection is immaterial	Not labelled, free line and load connection choice	P
	- load terminals, unless connection is immaterial		P
	- neutral pole terminal		N/A
	- protective earth terminal		N/A
	Data in the manufacturer's published information:		—
	- rated insulation voltage	800 V	P
	- rated impulse withstand voltage for equipment suitable for isolation or when determined	6 kV	P
	- pollution degree, if different from 3	3	P
	- rated duty	uninterrupted	P
	- rated short-time withstand current and duration		N/A
	- rated short-circuit making capacity		N/A

TRF No. IEC60947\_3B



988

IEC 60947-3			
Clause	Requirement + Test	Result - Remark	Verdict
	- rated conditional short-circuit current	50 kA, 100 kA	P
5.3	Instructions for installation, operation and maintenance		P
6	Normal service, mounting and transport conditions		P
7.1	CONSTRUCTIONAL AND PERFORMANCE REQUIREMENTS		P
7.1.2	Materials		P
7.1.2.2	Resistance to abnormal heat and fire		P
	Test performed on .....	- the equipment - sections taken from the equipment - samples of identical material	P
	Glow-wire test according to IEC 60695-2-10 and IEC 60695-2-11		—
	Parts made of insulating material necessary to retain current-carrying parts in position: test temperature 960 °C		P
	No visible flame and no sustained glowing		P
	Flames and glowing extinguish within 30 s		P
	No ignition of the tissue paper		P
	Parts of insulating material not necessary to retain current-carrying parts in position, even though in contact with them: test temperature 650 °C		P
	No visible flame and no sustained glowing		P
	Flames and glowing extinguish within 30 s		P
	No ignition of the tissue paper		P
7.1.3 of Part 1	Current-carrying parts and their connection		P
7.1.4	Clearances .....	see appended table 7.1.4 on page 103	P
	Creepage distances .....	see appended table 7.1.4 on page 103	P
	Pollution degree .....	3	—
	Comparative tracking index (V) .....	CTI 600 (housing) CTI 575 (actuator)	—
	Material group .....	II	—

TRF No. IEC60947\_3B



Handwritten signature and the number 908.

IEC 60947-3			
Clause	Requirement + Test	Result - Remark	Verdict
7.1.5 of Part 1	Actuator		P
7.1.5.1	Insulation		—
	Actuator insulated from live parts for		—
	- rated insulation voltage	800 V	P
	- rated impulse withstand voltage	6 kV	P
	Actuator made of metal		—
	- connected to a protective conductor or provided with an additional insulation		P
	Actuator made of or covered by insulating material :		—
	- internal metal parts, which might become accessible in the event of an insulation failure, are also insulated from live parts for the rated insulation voltage		P
7.1.5.2	Direction of movement		P
	The direction of operation for actuators shall where applicable conform to IEC 60447		P
	There is no doubt of the "I" and "O" position and the direction of operation		P
7.1.6 of Part 1	Indication of contact position		P
7.1.6.1	Indicating means		N/A
7.1.6.2	Indication by the actuator		P
7.1.7	Additional safety requirements for equipment suitable for isolation		P
7.1.7.1	Additional constructional requirements		P
	- marking according to 5.2.1b		P
	- indication of the position of the contacts		N/A
	- construction of the actuating mechanism		P
	- minimum clearances across open contacts (see Table 13, Part 1) (mm) .....	2 mm	—
	- measured clearances (mm) .....	> 5,5 mm	P
	- test Uimp across gap (kV) .....	9,8 kV	P



Handwritten signature and initials, possibly 'Али' and '989'.

IEC 60947-3			
Clause	Requirement + Test	Result - Remark	Verdict
7.1.7.2	Supplementary requirements for equipment with provision for electrical interlocking with contactors or circuit-breakers:		N/A
	Auxiliary switch is rated according to IEC 60947-5-1 (unless the equipment is rated AC-23)		N/A
	Time interval between opening of the contacts of the auxiliary contact and the contacts of the main poles: $\geq 20$ ms .....		—
	Measured time interval (ms) .....		N/A
	During the closing operation the contacts of the auxiliary switch closes after or simultaneously with the contacts of the main poles		N/A
7.1.7.3	Supplementary requirements for equipment provided with means for padlocking the open position:		N/A
	The locking means is so designed that it cannot be removed with the appropriate padlock(s) installed		N/A
	Test force F applied to the actuator in an attempt to operate to the closed position (N) .....		—
	Rated impulse withstand voltage (kV) .....		—
	Test Uimp on open main contacts at the test force		N/A
7.1.8 of Part 1	Terminals		P
7.1.8.1	All parts of terminals which maintain contact and carry current are of metal having adequate mechanical strength	(see 8.2.4 below)	P
	Terminal connections are such that necessary contact pressure is maintained	(see 8.2.4 below)	P
	Terminals are so constructed that the conductor is clamped between suitable surfaces without damage to the conductor and terminal	(see 8.2.4 below)	P
	Terminals do not allow the conductor to be displaced or to be displaced themselves in a manner detrimental to the operator of equipment and the insulation voltage is not reduced below the rated value	(see 8.2.4 below)	P



IEC 60947-3			
Clause	Requirement + Test	Result - Remark	Verdict
8.2.4	Mechanical properties of terminals (box terminal connection)		P
	Mechanical strength of terminals		P
	Maximum cross-sectional area of conductor (mm <sup>2</sup> ) .....:		—
	Diameter of thread (mm) .....:	Screw M5	—
	Torque (Nm) .....:	2,75 Nm (manufacturer indicates: 2 – 2,5 Nm)	—
	5 times on 2 separate clamping units		P
	Testing for damage to and accidental loosening of conductor (flexion test)		P
	Conductor of the smallest cross-sectional area (mm <sup>2</sup> ) .....:	0,75 mm <sup>2</sup>	—
	Number of conductor of the smallest cross section :	1	—
	Diameter of bushing hole (mm) .....:	6,5 mm	—
	Height between the equipment and the platen .....:	260 mm	—
	Mass at the conductor(s) (kg) .....:	0,4 kg	—
	135 continuous revolutions: the conductor neither slips out of the terminal nor breaks near the clamping unit		P
	Pull-out test		P
	Force (N), applied for 1 min. ....:	30 N	—
	During the test, the conductor neither slips out of the terminal nor breaks near the clamping unit		P
	Conductor of the largest cross-sectional area (mm <sup>2</sup> ) .....:	25 mm <sup>2</sup>	—
	Number of conductor of the largest cross section :	1	—
	Diameter of bushing hole (mm) .....:	13 mm	—
	Height between the equipment and the platen .....:	300 mm	—
	Mass at the conductor(s) (kg) .....:	4,5 kg	—
	135 continuous revolutions: the conductor neither slips out of the terminal nor breaks near the clamping unit		P
	Pull-out test		P
	Force (N), applied for 1 min. ....:	135 N	—
	During the test, the conductor neither slips out of the terminal nor breaks near the clamping unit		P

TRF No. IEC60947\_3B



991

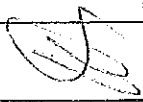

IEC 60947-3			
Clause	Requirement + Test	Result - Remark	Verdict
	Conductor of the largest and smallest cross-sectional area (mm <sup>2</sup> ) .....		—
	Number of conductor of the smallest cross section, number of conductor of the largest cross section ..		—
	Diameter of bushing hole (mm) .....		—
	Height between the equipment and the platen .....		—
	Mass at the conductor(s) (kg) .....		—
	135 continuous revolutions: the conductor neither slips out of the terminal nor breaks near the clamping unit		N/A
	Pull-out test		N/A
	Force (N), applied for 1 min. ....		—
	During the test, the conductor neither slips out of the terminal nor breaks near the clamping unit		N/A
7.1.8.2	Connection capacity		P
	Type of conductors .....	Rigid, stranded or flexible	—
	Minimum cross-sectional area of conductor (mm <sup>2</sup> ) :	0,75 mm <sup>2</sup>	—
	Maximum cross-sectional area of conductor (mm <sup>2</sup> ) .....	25 mm <sup>2</sup>	—
	Number of conductors simultaneously connectable to the terminal .....		—
7.1.8.3	Connection		P
	Terminals for connection to external conductors are readily accessible during installation		P
	Clamping screws and nuts do not serve to fix any other component		P
7.1.8.4	Terminal identification and marking		P
	Terminal intended exclusively for the neutral conductor	Only if applicable	P
	Protective earth terminal		N/A
	Other terminals		P

TRF No. IEC60947\_3B

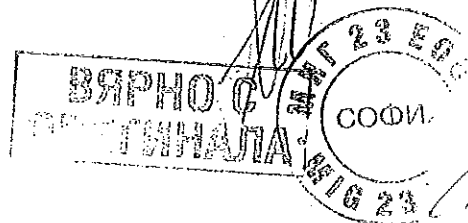

IEC 60947-3			
Clause	Requirement + Test	Result - Remark	Verdict
7.1.9	Additional requirements for equipment provided with a neutral pole		P
	Equipment provided with a pole intended for the connection of neutral, this pole shall be clearly marked by the letter "N"		P
	The switched neutral pole does not break before and does not make after the other poles except		N/A
	- a pole having the appropriate short-circuit breaking and making capacity is used as neutral pole, all poles may operate together	The connection is given by a dummy (piece of copper), which is inside the actuator.	P
	Conventional thermal current of neutral pole	32 A	P
7.1.10	Provisions for protective earthing		N/A
7.1.10.1	The exposed conductive parts are electrically interconnected and connected to a protective earth terminal		N/A
7.1.10.2	Protective earth terminal is readily accessible		N/A
	Protective earth terminal is suitably protected against corrosion		N/A
	Electrical continuity between the exposed conductive parts of the protective earth terminal and the metal sheathing of connecting conductors		N/A
	Protective earth terminal has no other functions		N/A
7.1.10.3	Protective earth terminal marking and identification		N/A
7.1.11	Enclosure for equipment		N/A
7.1.11.1	Design		N/A
	When the enclosure is opened, all parts requiring access for installation and maintenance are readily accessible		N/A
	Sufficient space is provided inside the enclosure		N/A
	The fixed parts of a metal enclosure are electrically connected to the other exposed conductive parts of the equipment and connected to a terminal which enables them to be earthed or connected to a protective conductor		N/A
	Under no circumstances a removable metal part of the enclosure is insulated from the part carrying the earth terminal when the removable part is in place		N/A
	The removable parts of the enclosure are firmly secured to the fixed parts by a device such that they cannot be accidentally loosened or detached owing to the effects of operation of the equipment or vibrations		N/A

TRF No. IEC60947\_3B

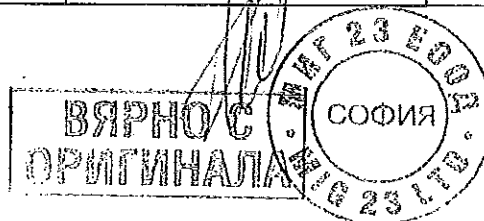

IEC 60947-3			
Clause	Requirement + Test	Result - Remark	Verdict
	When an enclosure is so designed as to allow the covers to be opened without the use of tools, means is provided to prevent loss of the fastening devices		N/A
	If the enclosure is used for mounting push-buttons, it is not possible to remove the buttons from the outside of the enclosure		N/A
7.1.11.2	Insulation		N/A
	If, in order to prevent accidental contact between a metallic enclosure and live parts, the enclosure is partly or completely lined with insulating material, then this lining is securely fixed to the enclosure		N/A
7.1.12	Degree of protection of enclosed equipment		N/A
	Degree of protection .....: IP		N/A
7.1.13	Conduit pull-out, torque and bending with metallic conduits		N/A
	Withstand the stress occurring during its installation .....: IP		N/A

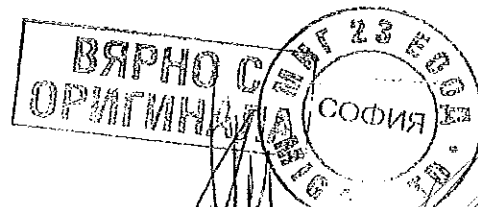

IEC 60947-3			
Clause	Requirement + Test	Result - Remark	Verdict
8.3.3	TEST SEQUENCE I: GENERAL PERFORMANCE CHARACTERISTICS (Sample No. 1: AC-21B, 500 V, 25 A, 1-pole)		P
8.3.3.1	Temperature-rise		P
	ambient temperature 10-40 °C .....	22,7 °C	—
	test enclosure W x H x D (mm x mm x mm) .....		—
	material of enclosure .....		—
	Main circuits, test conditions:		—
	- rated operational current $I_e$ (A) .....	25 A	—
	- cable/busbar cross-section (mm <sup>2</sup> ) / length (mm) ..	4 mm <sup>2</sup> cables / 1000 mm long	—
	Fuse-link details (fuse-combination units only):		—
	- manufacturer's name, trademark or identification mark .....	Bussmann	—
	- manufacturer's model or type reference .....	C10G25	—
	- rated current (A) .....	25A (gG)	—
	- power loss (W) .....	2,6 W	—
	- rated breaking capacity (kA) .....	120 kA	—
	Measured temperature-rise .....	see appended table 8.3.3.1 on page 103	P
	Auxiliary circuits, test conditions:		N/A
	- rated operation current (A) .....		—
	- cable cross-section (mm <sup>2</sup> ) .....		—
	Measured temperature-rise .....	see appended table 8.3.3.1 on page __	N/A
8.3.3.2	Test of dielectric properties		P
	Rated impulse withstand voltage (kV) .....	6 kV	—
	- test $U_{imp}$ main circuits (kV) .....	7,3 kV	P
	- test $U_{imp}$ auxiliary circuits (kV) .....		N/A
	- test $U_{imp}$ on open main contacts (equipment suitable for isolation) (kV) .....	9,8 kV	P
	Power-frequency withstand voltage (V) .....	800 V	—
	- main circuits, test voltage for 5 sec. (V) .....	2000 V	P
	- control and auxiliary circuits, test voltage for 5 sec. (V) .....		N/A

TRF No. IEC60947\_3B



995

IEC 60947-3			
Clause	Requirement + Test	Result - Remark	Verdict
	Devices, which have been disconnected for the power-frequency withstand voltage test .....		N/A
	Equipment suitable for isolation, leakage current not exceed 0,5 mA		—
	Test voltage 1,1 Ue (V) .....	550 V (tested with 759 V)	—
	Measured leakage current (mA) .....	0,001 mA	P
8.3.3.3	Making and breaking capacity		P
	- utilization category .....	AC-21B	—
	- rated operational voltage Ue (V) .....	500 V	—
	- rated operational current Ie (A) or power (kW) ....	25 A	—
	Fuse-link details (fuse-combination units only):		—
	- manufacturer's name, trademark or identification mark .....	Bussmann	—
	- manufacturer's model or type reference .....	C10G25	—
	- rated current (A) .....	25 A (gG)	—
	- power loss (W) .....	2,6 W	—
	- rated breaking capacity (kA) .....	120 kA	—
	Conditions for make/break operations or make operation, AC-23A and AC-23B only:		N/A
	- test voltage, U = 1,05 Ue .....	L1: L2: L3:	—
	- test current, I = ..... x Ie (A):	L1: L2: L3:	—
	- power factor .....	L1: L2: L3:	—
	Conditions for break operation, AC-23A and AC-23B only:		N/A
	- test voltage, U = 1,05 Ue .....	L1: L2: L3:	—
	- test current, I = ..... x Ie (A):	L1: L2: L3:	—
	- power factor .....	L1: L2: L3:	—



IEC 60947-3			
Clause	Requirement + Test	Result - Remark	Verdict
	Conditions for make/break operations, other than AC-23A/B:		P
	- test voltage, $U = 1,05 U_e$ ..... (V):	L1: 525 V L2: — L3: —	—
	- test current, $I =$ ..... $1,5 \times I_e$ (A):	L1: 38 A L2: — L3: —	—
	- power factor/ time constant .....	0,91	—
	Number of make/break or make and break operations .....	5	P
	- recovery voltage duration ( $\geq 50$ ms)	$> 50$ ms	P
	- current duration (ms) .....	70 ms	—
	- time interval between operations .....	30 s	P
	Characteristic of transient recovery voltage for AC-22 and AC-23 only		N/A
	- oscillatory frequency (kHz) .....		—
	- measured oscillatory frequency (kHz) .....	L1: L2: L3:	N/A
	- factor $\gamma$ .....	L1: L2: L3:	N/A
8.3.3.3.5	Behaviour of the equipment during making and breaking capacity tests		P
	Test performed without:		—
	- endanger to the operator		P
	- cause damage to adjacent equipment		P
	No permanent arcing		P
	No flash over between poles and poles and frame		P
	No melting of the fuse in the detection circuit		P
8.3.3.3.6	Condition of the equipment after making and breaking capacity tests		P
	Immediately after the test equipment must work satisfactorily		P
	- required opening force not greater than the test force of 8.2.5.2 and table 8	13,2 N (required opening force) 150 N (test force acc. tab. 8)	P
	- equipment is able to carry its rated current after normal closing operation		P



IEC 60947-3			
Clause	Requirement + Test	Result - Remark	Verdict
8.3.3.4	Dielectric verification		P
	test voltage: $2 \cdot U_e$ with a minimum of 1000V~ .....	1000 V (tested with 1380 V)	—
	No flashover or breakdown		P
8.3.3.5	Leakage current		P
	test voltage (1,1 $U_e$ ) (V) .....	550 V (tested with 759 V)	—
	Leakage current (utilization categories AC-20A, AC-20B, DC-20A and DC-20B): $\leq 0,5$ mA/pole .....		N/A
	Leakage current (other utilization categories): $\leq 2$ mA/pole) .....	< 2 mA	P
8.3.3.6	Temperature-rise verification		P
	Fuse-link details (fuse-combination units only):		—
	- manufacturer's name, trademark or identification mark .....	Bussmann	—
	- manufacturer's model or type reference .....	C10G25	—
	- rated current (A) .....	25 A (gG)	—
	- power loss (W) .....	2,6 W	—
	- rated breaking capacity (kA) .....	120 kA	—
	- conductor cross-section (mm <sup>2</sup> ) .....	4 mm <sup>2</sup>	—
	- test current $I_e$ (A) .....	25 A	—
	Measured temperature-rise .....	see appended table 8.3.3.6 on page 103	P
8.3.3.7	Strength of actuator mechanism		P
8.2.5	Verification of the strength of actuator mechanism and position indicating device		
	- actuator type (fig.) .....	figure 1b (one-finger operated)	—
8.2.5.2.1	Dependent and independent manual operation	dependent manual operation	P
	- actuating force for opening (N) .....	10,2 N	—
	- test force with blocked main contacts (N) .....	50 N	—
	- used method to keep the contact closed .....	Fuse-links were held tight with a piece of wire	—
	During and after the test, open position not indicated .....		P
	Equipment with locking mean, no locking in the open position while test force is applied .....		P

TRF No. IEC60947\_3B



IEC 60947-3			
Clause	Requirement + Test	Result - Remark	Verdict
8.2.5.2.2	Dependent power operation		N/A
	- main contacts fixed together in the closed position:		N/A
	- used method to keep the contact closed .....		N/A
	- 110% of the rated supply voltage applied to the equipment (3 times) .....		N/A
	During and after the test, open position not indicated .....		N/A
	Equipment show no damage impairing its normal operation .....		N/A
	Equipment with locking mean, no locking in the open position while test force is applied .....		N/A
8.2.5.2.3	Independent power operation		N/A
	- main contacts fixed together in the closed position:		N/A
	- used method to keep the contact closed .....		N/A
	- stored energy of the power operator released (3 times) .....		N/A
	During and after the test, open position not indicated .....		N/A
	Equipment show no damage impairing its normal operation .....		N/A
	Equipment with locking mean, no locking in the open position while test force is applied .....		N/A

ВЯРНО С  
ОРИГИНАЛА

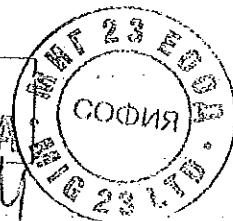

999



IEC 60947-3			
Clause	Requirement + Test	Result - Remark	Verdict
8.3.3	TEST SEQUENCE I: GENERAL PERFORMANCE CHARACTERISTICS (Sample No. 2: AC-21B, 690 V, 10 A, 1-pole)		P
8.3.3.1	Temperature-rise		P
	ambient temperature 10-40 °C .....	22,7 °C	—
	test enclosure W x H x D (mm x mm x mm) .....		—
	material of enclosure .....		—
	Main circuits, test conditions:		—
	- rated operational current I <sub>e</sub> (A) .....	10 A	—
	- cable/busbar cross-section (mm <sup>2</sup> ) / length (mm) ..	1,5 mm <sup>2</sup> cables / 1000mm long	—
	Fuse-link details (fuse-combination units only):		—
	- manufacturer's name, trademark or identification mark .....	SIBA	—
	- manufacturer's model or type reference .....	50 179 06.10	—
	- rated current (A) .....	10 A (gR)	—
	- power loss (W) .....	2,3 W	—
	- rated breaking capacity (kA) .....	200 kA	—
	Measured temperature-rise .....	see appended table 8.3.3.1 on page 104	P
	Auxiliary circuits, test conditions:		N/A
	- rated operation current (A) .....		—
	- cable cross-section (mm <sup>2</sup> ) .....		—
	Measured temperature-rise .....	see appended table 8.3.3.1 on page __	N/A
8.3.3.2	Test of dielectric properties		P
	Rated impulse withstand voltage (kV) .....	6 kV	—
	- test U <sub>imp</sub> main circuits (kV) .....	7,3 kV	P
	- test U <sub>imp</sub> auxiliary circuits (kV) .....		N/A
	- test U <sub>imp</sub> on open main contacts (equipment suitable for isolation) (kV) .....	9,8 kV	P
	Power-frequency withstand voltage (V) .....	800 V	—
	- main circuits, test voltage for 5 sec. (V) .....	2000 V	P
	- control and auxiliary circuits, test voltage for 5 sec. (V) .....		N/A

TRF No. IEC60947\_3B

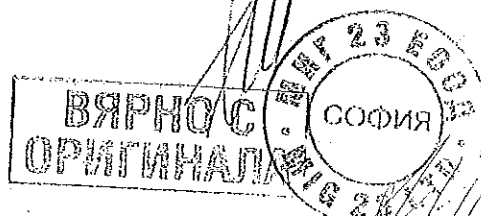

1077

IEC 60947-3			
Clause	Requirement + Test	Result - Remark	Verdict
	Devices, which have been disconnected for the power-frequency withstand voltage test .....		N/A
	Equipment suitable for isolation, leakage current not exceed 0,5 mA		—
	Test voltage 1,1 Ue (V) .....	759 V	—
	Measured leakage current (mA) .....	0,001 mA	P
8.3.3.3	Making and breaking capacity		P
	- utilization category .....	AC-21B	—
	- rated operational voltage Ue (V) .....	690 V	—
	- rated operational current Ie (A) or power (kW) ....	10 A	—
	Fuse-link details (fuse-combination units only):		—
	- manufacturer's name, trademark or identification mark .....	SIBA	—
	- manufacturer's model or type reference .....	50 179 06.10	—
	- rated current (A) .....	10 A (gR)	—
	- power loss (W) .....	2,3 W	—
	- rated breaking capacity (kA) .....	200 kA	—
	Conditions for make/break operations or make operation, AC-23A and AC-23B only:		N/A
	- test voltage, U = 1,05 Ue ..... (V):	L1: L2: L3:	—
	- test current, I = ..... x Ie (A):	L1: L2: L3:	—
	- power factor .....	L1: L2: L3:	—
	Conditions for break operation, AC-23A and AC-23B only:		N/A
	- test voltage, U = 1,05 Ue ..... (V):	L1: L2: L3:	—
	- test current, I = ..... x Ie (A):	L1: L2: L3:	—
	- power factor .....	L1: L2: L3:	—



IEC 60947-3			
Clause	Requirement + Test	Result - Remark	Verdict
	Conditions for make/break operations, other than AC-23A/B:		P
	- test voltage, $U = 1,05 U_e$ ..... (V):	L1: 725 V L2: — L3: —	—
	- test current, $I =$ ..... $1,5 \times I_e$ (A):	L1: 15,3 A L2: — L3: —	—
	- power factor/ time constant .....	0,95	—
	Number of make/break or make and break operations .....	5	P
	- recovery voltage duration ( $\geq 50$ ms)	> 50 ms	P
	- current duration (ms) .....	70 ms	—
	- time interval between operations .....	30 s	P
	Characteristic of transient recovery voltage for AC-22 and AC-23 only		N/A
	- oscillatory frequency (kHz) .....		—
	- measured oscillatory frequency (kHz) .....	L1: L2: L3:	N/A
	- factor $\gamma$ .....	L1: L2: L3:	N/A
8.3.3.3.5	Behaviour of the equipment during making and breaking capacity tests		P
	Test performed without:		—
	- endanger to the operator		P
	- cause damage to adjacent equipment		P
	No permanent arcing		P
	No flash over between poles and poles and frame		P
	No melting of the fuse in the detection circuit		P
8.3.3.3.6	Condition of the equipment after making and breaking capacity tests		P
	Immediately after the test equipment must work satisfactorily		P
	- required opening force not greater than the test force of 8.2.5.2 and table 8	17,6 N (required opening force) 150 N (test force acc. tab. 8)	P
	- equipment is able to carry its rated current after normal closing operation		P

TRF No. IEC60947\_3B

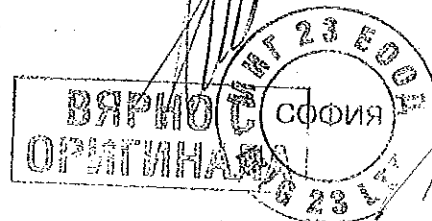

1002

IEC 60947-3			
Clause	Requirement + Test	Result - Remark	Verdict
8.3.3.4	Dielectric verification		P
	test voltage: $2 \cdot U_e$ with a minimum of 1000V~ .....	1380 V	—
	No flashover or breakdown		P
8.3.3.5	Leakage current		P
	test voltage (1,1 $U_e$ ) (V) .....	759 V	—
	Leakage current (utilization categories AC-20A, AC-20B, DC-20A and DC-20B): $\leq 0,5$ mA/pole .....		N/A
	Leakage current (other utilization categories): $\leq 2$ mA/pole) .....	< 2 mA	P
8.3.3.6	Temperature-rise verification		P
	Fuse-link details (fuse-combination units only):		—
	- manufacturer's name, trademark or identification mark .....	SIBA	—
	- manufacturer's model or type reference .....	50 179 06.10	—
	- rated current (A) .....	10 A (gR)	—
	- power loss (W) .....	2,3 W	—
	- rated breaking capacity (kA) .....	200 kA	—
	- conductor cross-section (mm <sup>2</sup> ) .....	1,5 mm <sup>2</sup>	—
	- test current $I_e$ (A) .....	10 A	—
	Measured temperature-rise .....	see appended table 8.3.3.6 on page 104	P
8.3.3.7	Strength of actuator mechanism		P
8.2.5	Verification of the strength of actuator mechanism and position indicating device		—
	- actuator type (fig.) .....	figure 1b (one-finger operated)	—
8.2.5.2.1	Dependent and independent manual operation	dependent manual operation	P
	- actuating force for opening (N) .....	11 N	—
	- test force with blocked main contacts (N) .....	50 N	—
	- used method to keep the contact closed .....	Fuse-links were held tight with a piece of wire	—
	During and after the test, open position not indicated .....		P
	Equipment with locking mean, no locking in the open position while test force is applied .....		P



IEC 60947-3			
Clause	Requirement + Test	Result - Remark	Verdict
8.2.5.2.2	Dependent power operation		N/A
	- main contacts fixed together in the closed position:		N/A
	- used method to keep the contact closed .....		N/A
	- 110% of the rated supply voltage applied to the equipment (3 times) .....		N/A
	During and after the test, open position not indicated .....		N/A
	Equipment show no damage impairing its normal operation .....		N/A
	Equipment with locking mean, no locking in the open position while test force is applied .....		N/A
8.2.5.2.3	Independent power operation		N/A
	- main contacts fixed together in the closed position:		N/A
	- used method to keep the contact closed .....		N/A
	- stored energy of the power operator released (3 times) .....		N/A
	During and after the test, open position not indicated .....		N/A
	Equipment show no damage impairing its normal operation .....		N/A
	Equipment with locking mean, no locking in the open position while test force is applied .....		N/A

TRF No. IEC60947\_3B

ВЪРНО С  
ОРИГИНАЛА

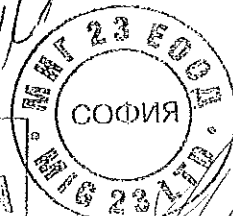

1004

IEC 60947-3			
Clause	Requirement + Test	Result - Remark	Verdict
8.3.3	TEST SEQUENCE I: GENERAL PERFORMANCE CHARACTERISTICS (Sample No. 3: AC-22B, 400 V, 32 A, 1-pole)		P
8.3.3.1	Temperature-rise		P
	ambient temperature 10-40 °C .....	22,7 °C	—
	test enclosure W x H x D (mm x mm x mm) .....		—
	material of enclosure .....		—
	Main circuits, test conditions:		—
	- rated operational current I <sub>e</sub> (A) .....	32 A	—
	- cable/busbar cross-section (mm <sup>2</sup> ) / length (mm) ..	6 mm <sup>2</sup> cables / 1000mm long	—
	Fuse-link details (fuse-combination units only):		—
	- manufacturer's name, trademark or identification mark .....	Bussmann	—
	- manufacturer's model or type reference .....	C10G32	—
	- rated current (A) .....	32 A (gG)	—
	- power loss (W) .....	2,9 W	—
	- rated breaking capacity (kA) .....	120 kA	—
	Measured temperature-rise .....	see appended table 8.3.3.1 on page 104	P
	Auxiliary circuits, test conditions:		N/A
	- rated operation current (A) .....		—
	- cable cross-section (mm <sup>2</sup> ) .....		—
	Measured temperature-rise .....	see appended table 8.3.3.1 on page ___	N/A
8.3.3.2	Test of dielectric properties		P
	Rated impulse withstand voltage (kV) .....	6 kV	—
	- test U <sub>imp</sub> main circuits (kV) .....	7,3 kV	P
	- test U <sub>imp</sub> auxiliary circuits (kV) .....		N/A
	- test U <sub>imp</sub> on open main contacts (equipment suitable for isolation) (kV) .....	9,8 kV	P
	Power-frequency withstand voltage (V) .....	800 V	—
	- main circuits, test voltage for 5 sec. (V) .....	2000 V	P
	- control and auxiliary circuits, test voltage for 5 sec. (V) .....		N/A



1005

IEC 60947-3			
Clause	Requirement + Test	Result - Remark	Verdict
	Devices, which have been disconnected for the power-frequency withstand voltage test .....		N/A
	Equipment suitable for isolation, leakage current not exceed 0,5 mA		—
	Test voltage 1,1 Ue (V) .....	440 V (tested with 759 V)	—
	Measured leakage current (mA) .....	0,001 mA	P
8.3.3.3	Making and breaking capacity		P
	- utilization category .....	AC-22B	—
	- rated operational voltage Ue (V) .....	400 V	—
	- rated operational current Ie (A) or power (kW) .....	32 A	—
	Fuse-link details (fuse-combination units only):		—
	- manufacturer's name, trademark or identification mark .....	Bussmann	—
	- manufacturer's model or type reference .....	C10G32	—
	- rated current (A) .....	32 A (gG)	—
	- power loss (W) .....	2,9 W	—
	- rated breaking capacity (kA) .....	120 kA	—
	Conditions for make/break operations or make operation, AC-23A and AC-23B only:		N/A
	- test voltage, U = 1,05 Ue .....	L1: L2: L3:	—
	- test current, I = ..... x Ie (A):	L1: L2: L3:	—
	- power factor .....	L1: L2: L3:	—
	Conditions for break operation, AC-23A and AC-23B only:		N/A
	- test voltage, U = 1,05 Ue .....	L1: L2: L3:	—
	- test current, I = ..... x Ie (A):	L1: L2: L3:	—
	- power factor .....	L1: L2: L3:	—

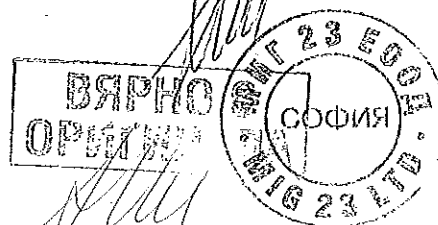

IEC 60947-3			
Clause	Requirement + Test	Result - Remark	Verdict
	Conditions for make/break operations, other than AC-23A/B:		P
	- test voltage, $U = 1,05 U_e$ ..... (V):	L1: 420 V L2: — L3: —	—
	- test current, $I =$ ..... $3 \times I_e$ (A):	L1: 98 A L2: — L3: —	—
	- power factor/ time constant .....	0,66	—
	Number of make/break or make and break operations .....	5	P
	- recovery voltage duration ( $\geq 50$ ms)	$> 50$ ms	P
	- current duration (ms) .....	90 ms	—
	- time interval between operations .....	30 s	P
	Characteristic of transient recovery voltage for AC-22 and AC-23 only		P
	- oscillatory frequency (kHz) .....	41,29 kHz	—
	- measured oscillatory frequency (kHz) .....	L1: 40,5 kHz L2: — L3: —	P
	- factor $\gamma$ .....	L1: 1,1 L2: — L3: —	P
8.3.3.3.5	Behaviour of the equipment during making and breaking capacity tests		P
	Test performed without:		—
	- endanger to the operator		P
	- cause damage to adjacent equipment		P
	No permanent arcing		P
	No flash over between poles and poles and frame		P
	No melting of the fuse in the detection circuit		P
8.3.3.3.6	Condition of the equipment after making and breaking capacity tests		P
	Immediately after the test equipment must work satisfactorily		P
	- required opening force not greater than the test force of 8.2.5.2 and table 8	8,4 N (required opening force) 150 N (test force acc. tab. 8)	P
	- equipment is able to carry its rated current after normal closing operation		P

TRF No. IEC60947\_3B

ВЯРНО С  
ОРИГИНАЛА

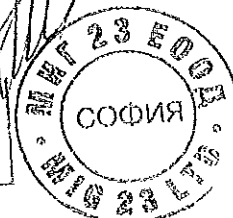

1007



IEC 60947-3			
Clause	Requirement + Test	Result - Remark	Verdict
8.3.3.4	Dielectric verification		P
	test voltage: $2 \cdot U_e$ with a minimum of 1000V~ .....	1000 V (tested with 1380 V)	—
	No flashover or breakdown		P
8.3.3.5	Leakage current		P
	test voltage ( $1,1 U_e$ ) (V) .....	440 V (tested with 759 V)	—
	Leakage current (utilization categories AC-20A, AC-20B, DC-20A and DC-20B): $\leq 0,5$ mA/pole .....		N/A
	Leakage current (other utilization categories): $\leq 2$ mA/pole) .....	< 2 mA	P
8.3.3.6	Temperature-rise verification		P
	Fuse-link details (fuse-combination units):		—
	- manufacturer's name, trademark or identification mark .....	Bussmann	—
	- manufacturer's model or type reference .....	C10G32	—
	- rated current (A) .....	32 A (gG)	—
	- power loss (W) .....	2,9 W	—
	- rated breaking capacity (kA) .....	120 kA	—
	- conductor cross-section (mm <sup>2</sup> ) .....	6 mm <sup>2</sup>	—
	- test current $I_e$ (A) .....	32 A	—
	Measured temperature-rise .....	see appended table 8.3.3.6 on page 105	P
8.3.3.7	Strength of actuator mechanism		P
8.2.5	Verification of the strength of actuator mechanism and position indicating device		
	- actuator type (fig.) .....	figure 1b (one-finger operated)	—
8.2.5.2.1	Dependent and independent manual operation	dependent manual operation	P
	- actuating force for opening (N) .....	10,4 N	—
	- test force with blocked main contacts (N) .....	50 N	—
	- used method to keep the contact closed .....	Fuse-links were held tight with a piece of wire	—
	During and after the test, open position not indicated .....		P
	Equipment with locking mean, no locking in the open position while test force is applied .....		P

TRF No. IEC60947\_3B



100%

IEC 60947-3			
Clause	Requirement + Test	Result - Remark	Verdict
8.2.5.2.2	Dependent power operation		N/A
	- main contacts fixed together in the closed position:		N/A
	- used method to keep the contact closed .....		N/A
	- 110% of the rated supply voltage applied to the equipment (3 times) .....		N/A
	During and after the test, open position not indicated .....		N/A
	Equipment show no damage impairing its normal operation .....		N/A
	Equipment with locking mean, no locking in the open position while test force is applied .....		N/A
8.2.5.2.3	Independent power operation		N/A
	- main contacts fixed together in the closed position:		N/A
	- used method to keep the contact closed .....		N/A
	- stored energy of the power operator released (3 times) .....		N/A
	During and after the test, open position not indicated .....		N/A
	Equipment show no damage impairing its normal operation .....		N/A
	Equipment with locking mean, no locking in the open position while test force is applied .....		N/A



IEC 60947-3			
Clause	Requirement + Test	Result - Remark	Verdict
8.3.3	TEST SEQUENCE I: GENERAL PERFORMANCE CHARACTERISTICS (Sample No. 4: AC-22B, 400 V, 32 A, 2-poles)		P
8.3.3.1	Temperature-rise		P
	ambient temperature 10-40 °C .....	22,7 °C	—
	test enclosure W x H x D (mm x mm x mm) .....		—
	material of enclosure .....		—
	Main circuits, test conditions:		—
	- rated operational current I <sub>e</sub> (A) .....	32 A	—
	- cable/busbar cross-section (mm <sup>2</sup> ) / length (mm) ..	6 mm <sup>2</sup> cables / 1000mm long	—
	Fuse-link details (fuse-combination units only):		—
	- manufacturer's name, trademark or identification mark .....	Bussmann	—
	- manufacturer's model or type reference .....	C10G32	—
	- rated current (A) .....	32 A (gG)	—
	- power loss (W) .....	2,9 W	—
	- rated breaking capacity (kA) .....	120 kA	—
	Measured temperature-rise .....	see appended table 8.3.3.1 on page 105	P
	Auxiliary circuits, test conditions:		N/A
	- rated operation current (A) .....		—
	- cable cross-section (mm <sup>2</sup> ) .....		—
	Measured temperature-rise .....	see appended table 8.3.3.1 on page __	N/A
8.3.3.2	Test of dielectric properties		P
	Rated impulse withstand voltage (kV) .....	6 kV	—
	- test U <sub>imp</sub> main circuits (kV) .....	7,3 kV	P
	- test U <sub>imp</sub> auxiliary circuits (kV) .....		N/A
	- test U <sub>imp</sub> on open main contacts (equipment suitable for isolation) (kV) .....	9,8 kV	P
	Power-frequency withstand voltage (V) .....	800 V	—
	- main circuits, test voltage for 5 sec. (V) .....	2000 V	P
	- control and auxiliary circuits, test voltage for 5 sec. (V) .....		N/A

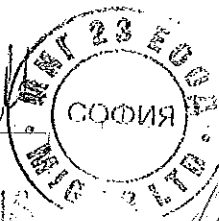

*[Handwritten signature]*  
10/0

IEC 60947-3			
Clause	Requirement + Test	Result - Remark	Verdict
	Devices, which have been disconnected for the power-frequency withstand voltage test .....		N/A
	Equipment suitable for isolation, leakage current not exceed 0,5 mA		—
	Test voltage 1,1 Ue (V) .....	440 V (tested with 759 V)	—
	Measured leakage current (mA) .....	0,001 mA	P
8.3.3.3	Making and breaking capacity		P
	- utilization category .....	AC-22B	—
	- rated operational voltage Ue (V) .....	400 V	—
	- rated operational current Ie (A) or power (kW) .....	32 A	—
	Fuse-link details (fuse-combination units only):		—
	- manufacturer's name, trademark or identification mark .....	Bussmann	—
	- manufacturer's model or type reference .....	C10G32	—
	- rated current (A) .....	32 A (gG)	—
	- power loss (W) .....	2,9 W	—
	- rated breaking capacity (kA) .....	120 kA	—
	Conditions for make/break operations or make operation, AC-23A and AC-23B only:		N/A
	- test voltage, U = 1,05 Ue ..... (V):	L1: L2: L3:	—
	- test current, I = ..... x Ie (A):	L1: L2: L3:	—
	- power factor .....	L1: L2: L3:	—
	Conditions for break operation, AC-23A and AC-23B only:		N/A
	- test voltage, U = 1,05 Ue ..... (V):	L1: L2: L3:	—
	- test current, I = ..... x Ie (A):	L1: L2: L3:	—
	- power factor .....	L1: L2: L3:	—

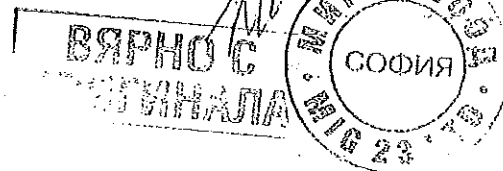

IEC 60947-3			
Clause	Requirement + Test	Result - Remark	Verdict
	Conditions for make/break operations, other than AC-23A/B:		P
	- test voltage, $U = 1,05 U_e$ ..... (V):	L1: 420 V ( $242,5 V \times \sqrt{3}$ ) L2: 420 V ( $242,5 V \times \sqrt{3}$ ) L3: —	—
	- test current, $I =$ ..... $3 \times I_e$ (A):	L1: 98 A L2: 98 A L3: —	—
	- power factor/ time constant .....	0,66	—
	Number of make/break or make and break operations .....	5	P
	- recovery voltage duration ( $\geq 50$ ms)	> 50 ms	P
	- current duration (ms) .....	70 ms	—
	- time interval between operations .....	30 s	P
	Characteristic of transient recovery voltage for AC-22 and AC-23 only		P
	- oscillatory frequency (kHz) .....	41,29 kHz	—
	- measured oscillatory frequency (kHz) .....	L1: 40,5 kHz L2: 40,5 kHz L3: —	P
	- factor $\gamma$ .....	L1: 1,1 L2: 1,1 L3: —	P
8.3.3.3.5	Behaviour of the equipment during making and breaking capacity tests		P
	Test performed without:		—
	- endanger to the operator		P
	- cause damage to adjacent equipment		P
	No permanent arcing		P
	No flash over between poles and poles and frame		P
	No melting of the fuse in the detection circuit		P
8.3.3.3.6	Condition of the equipment after making and breaking capacity tests		P
	Immediately after the test equipment must work satisfactorily		P
	- required opening force not greater than the test force of 8.2.5.2 and table 8	17,8 N (required opening force) 150 N (test force acc. tab. 8)	P
	- equipment is able to carry its rated current after normal closing operation		P

TRF No. IEC60947\_3B

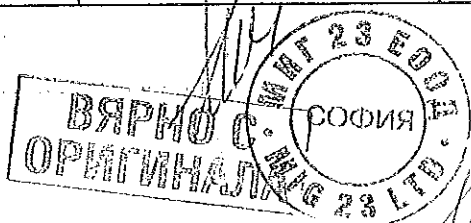

1017

IEC 60947-3			
Clause	Requirement + Test	Result - Remark	Verdict
8.3.3.4	Dielectric verification		P
	test voltage: $2 \cdot U_e$ with a minimum of 1000V~ .....	1000 V (tested with 1380 V)	—
	No flashover or breakdown		P
8.3.3.5	Leakage current		P
	test voltage (1,1 $U_e$ ) (V) .....	440 V (tested with 759 V)	—
	Leakage current (utilization categories AC-20A, AC-20B, DC-20A and DC-20B): $\leq 0,5$ mA/pole .....		N/A
	Leakage current (other utilization categories): $\leq 2$ mA/pole .....	< 2 mA	P
8.3.3.6	Temperature-rise verification		P
	Fuse-link details (fuse-combination units only):		—
	- manufacturer's name, trademark or identification mark .....	Bussmann	—
	- manufacturer's model or type reference .....	C10G32	—
	- rated current (A) .....	32 A (gG)	—
	- power loss (W) .....	2,9 W	—
	- rated breaking capacity (kA) .....	120 kA	—
	- conductor cross-section (mm <sup>2</sup> ) .....	6 mm <sup>2</sup>	—
	- test current $I_e$ (A) .....	32 A	—
	Measured temperature-rise .....	see appended table 8.3.3.6 on page 105	P
8.3.3.7	Strength of actuator mechanism		P
8.2.5	Verification of the strength of actuator mechanism and position indicating device		—
	- actuator type (fig.) .....	figure 1b (one-finger operated)	—
8.2.5.2.1	Dependent and independent manual operation	dependent manual operation	P
	- actuating force for opening (N) .....	22 N	—
	- test force with blocked main contacts (N) .....	66 N	—
	- used method to keep the contact closed .....	Fuse-links were held tight with a piece of wire	—
	During and after the test, open position not indicated .....		P
	Equipment with locking mean, no locking in the open position while test force is applied .....		P



IEC 60947-3			
Clause	Requirement + Test	Result - Remark	Verdict
8.2.5.2.2	Dependent power operation		N/A
	- main contacts fixed together in the closed position:		N/A
	- used method to keep the contact closed .....		N/A
	- 110% of the rated supply voltage applied to the equipment (3 times) .....		N/A
	During and after the test, open position not indicated .....		N/A
	Equipment show no damage impairing its normal operation .....		N/A
	Equipment with locking mean, no locking in the open position while test force is applied .....		N/A
8.2.5.2.3	Independent power operation		N/A
	- main contacts fixed together in the closed position:		N/A
	- used method to keep the contact closed .....		N/A
	- stored energy of the power operator released (3 times) .....		N/A
	During and after the test, open position not indicated .....		N/A
	Equipment show no damage impairing its normal operation .....		N/A
	Equipment with locking mean, no locking in the open position while test force is applied .....		N/A

TRF No. IEC60947\_3B

ВЯРНО С  
ОРИГИНАЛА

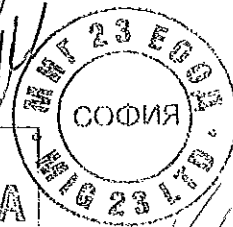

Handwritten signature and the number 1019.

IEC 60947-3			
Clause	Requirement + Test	Result - Remark	Verdict
8.3.3	TEST SEQUENCE I: GENERAL PERFORMANCE CHARACTERISTICS (Sample No. 5: AC-22B, 500 V, 25 A, 2-pole)		P
8.3.3.1	Temperature-rise		P
	ambient temperature 10-40 °C .....	22,7 °C	—
	test enclosure W x H x D (mm x mm x mm) .....		—
	material of enclosure .....		—
	Main circuits, test conditions:		—
	- rated operational current I <sub>e</sub> (A) .....	25 A	—
	- cable/busbar cross-section (mm <sup>2</sup> ) / length (mm) .....	4 mm <sup>2</sup> cables / 1000 mm long	—
	Fuse-link details (fuse-combination units only):		—
	- manufacturer's name, trademark or identification mark .....	Bussmann	—
	- manufacturer's model or type reference .....	C10G25	—
	- rated current (A) .....	25 A (gG)	—
	- power loss (W) .....	2,6 W	—
	- rated breaking capacity (kA) .....	120 kA	—
	Measured temperature-rise .....	see appended table 8.3.3.1 on page 106	P
	Auxiliary circuits, test conditions:		N/A
	- rated operation current (A) .....		—
	- cable cross-section (mm <sup>2</sup> ) .....		—
	Measured temperature-rise .....	see appended table 8.3.3.1 on page	N/A
8.3.3.2	Test of dielectric properties		P
	Rated impulse withstand voltage (kV) .....	6 kV	—
	- test U <sub>imp</sub> main circuits (kV) .....	7,3 kV	P
	- test U <sub>imp</sub> auxiliary circuits (kV) .....		N/A
	- test U <sub>imp</sub> on open main contacts (equipment suitable for isolation) (kV) .....	9,8 kV	P
	Power-frequency withstand voltage (V) .....	800 V	—
	- main circuits, test voltage for 5 sec. (V) .....	2000 V	P
	- control and auxiliary circuits, test voltage for 5 sec. (V) .....		N/A

TRF No. IEC60947\_3B



Handwritten signature and the number 1015.



IEC 60947-3			
Clause	Requirement + Test	Result - Remark	Verdict
	Devices, which have been disconnected for the power-frequency withstand voltage test .....		N/A
	Equipment suitable for isolation, leakage current not exceed 0,5 mA		—
	Test voltage 1,1 Ue (V) .....	550 V (tested with 759 V)	—
	Measured leakage current (mA) .....	0,001 mA	P
8.3.3.3	Making and breaking capacity		P
	- utilization category .....	AC-22B	—
	- rated operational voltage Ue (V) .....	500 V	—
	- rated operational current Ie (A) or power (kW) .....	25 A	—
	Fuse-link details (fuse-combination units only):		—
	- manufacturer's name, trademark or identification mark .....	Bussmann	—
	- manufacturer's model or type reference .....	C10G25	—
	- rated current (A) .....	25 A	—
	- power loss (W) .....	2,6 W	—
	- rated breaking capacity (kA) .....	120 kA	—
	Conditions for make/break operations or make operation, AC-23A and AC-23B only:		N/A
	- test voltage, $U = 1,05 U_e$ ..... (V):	L1: L2: L3:	—
	- test current, $I =$ ..... x Ie (A):	L1: L2: L3:	—
	- power factor .....	L1: L2: L3:	—
	Conditions for break operation, AC-23A and AC-23B only:		N/A
	- test voltage, $U = 1,05 U_e$ ..... (V):	L1: L2: L3:	—
	- test current, $I =$ ..... x Ie (A):	L1: L2: L3:	—
	- power factor .....	L1: L2: L3:	—

TRF No. IEC60947\_3B



Handwritten signature and the number '40 66'.

IEC 60947-3			
Clause	Requirement + Test	Result - Remark	Verdict
	Conditions for make/break operations, other than AC-23A/B:		
	- test voltage, $U = 1,05 U_e$ ..... (V):	L1: 525 V (303 V x $\sqrt{3}$ ) L2: 525 V (303 V x $\sqrt{3}$ ) L3: —	—
	- test current, $I =$ ..... 3 x $I_e$ (A):	L1: 78 A L2: 78 A L3: —	—
	- power factor/ time constant .....	0,68	—
	Number of make/break or make and break operations .....	5	P
	- recovery voltage duration ( $\geq 50$ ms)	> 50 ms	P
	- current duration (ms) .....	70 ms	—
	- time interval between operations .....	30 s	P
	Characteristic of transient recovery voltage for AC-22 and AC-23 only		P
	- oscillatory frequency (kHz) .....	32,88 kHz	—
	- measured oscillatory frequency (kHz) .....	L1: 32,2 kHz L2: 32,2 kHz L3: —	P
	- factor $\gamma$ .....	L1: 1,1 L2: 1,1 L3: —	P
8.3.3.3.5	Behaviour of the equipment during making and breaking capacity tests		P
	Test performed without:		—
	- endanger to the operator		P
	- cause damage to adjacent equipment		P
	No permanent arcing		P
	No flash over between poles and poles and frame		P
	No melting of the fuse in the detection circuit		P
8.3.3.3.6	Condition of the equipment after making and breaking capacity tests		P
	Immediately after the test equipment must work satisfactorily		P
	- required opening force not greater than the test force of 8.2.5.2 and table 8	20,4 N (required opening force) 150 N (test force acc. tab. 8)	P
	- equipment is able to carry its rated current after normal closing operation		P

TRF No. IEC60947\_3B

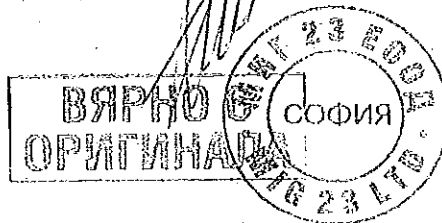

*[Handwritten signature]*

10/7

IEC 60947-3			
Clause	Requirement + Test	Result - Remark	Verdict
8.3.3.4	Dielectric verification		P
	test voltage: $2 \cdot U_e$ with a minimum of 1000V~ .....	1000 V (tested with 1380 V)	—
	No flashover or breakdown		P
8.3.3.5	Leakage current		P
	test voltage (1,1 $U_e$ ) (V) .....	550 V (tested with 759 V)	—
	Leakage current (utilization categories AC-20A, AC-20B, DC-20A and DC-20B): $\leq 0,5$ mA/pole .....		N/A
	Leakage current (other utilization categories): $\leq 2$ mA/pole) .....	< 2 mA	P
8.3.3.6	Temperature-rise verification		P
	Fuse-link details (fuse-combination units only):		—
	- manufacturer's name, trademark or identification mark .....	Bussmann	—
	- manufacturer's model or type reference .....	C10G25	—
	- rated current (A) .....	25 A (gG)	—
	- power loss (W) .....	2,6 W	—
	- rated breaking capacity (kA) .....	120 kA	—
	- conductor cross-section (mm <sup>2</sup> ) .....	4 mm <sup>2</sup>	—
	- test current $I_e$ (A) .....	25 A	—
	Measured temperature-rise .....	see appended table 8.3.3.6 on page 106	P
8.3.3.7	Strength of actuator mechanism		P
8.2.5	Verification of the strength of actuator mechanism and position indicating device		
	- actuator type (fig.) .....	figure 1b (one-finger operated)	—
8.2.5.2.1	Dependent and independent manual operation	dependent manual operation	P
	- actuating force for opening (N) .....	22,6 N	—
	- test force with blocked main contacts (N) .....	67,8 N	—
	- used method to keep the contact closed .....	Fuse-links were held tight with a piece of wire	—
	During and after the test, open position not indicated .....		P
	Equipment with locking mean, no locking in the open position while test force is applied .....		P

IEC 60947-3			
Clause	Requirement + Test	Result - Remark	Verdict
8.2.5.2.2	Dependent power operation		N/A
	- main contacts fixed together in the closed position:		N/A
	- used method to keep the contact closed .....		N/A
	- 110% of the rated supply voltage applied to the equipment (3 times) .....		N/A
	During and after the test, open position not indicated .....		N/A
	Equipment show no damage impairing its normal operation .....		N/A
	Equipment with locking mean, no locking in the open position while test force is applied .....		N/A
8.2.5.2.3	Independent power operation		N/A
	- main contacts fixed together in the closed position:		N/A
	- used method to keep the contact closed .....		N/A
	- stored energy of the power operator released (3 times) .....		N/A
	During and after the test, open position not indicated .....		N/A
	Equipment show no damage impairing its normal operation .....		N/A
	Equipment with locking mean, no locking in the open position while test force is applied .....		N/A



IEC 60947-3			
Clause	Requirement + Test	Result - Remark	Verdict
8.3.3	TEST SEQUENCE I: GENERAL PERFORMANCE CHARACTERISTICS (Sample No. 6: AC-22B, 690 V, 10 A, 2-pole)		P
8.3.3.1	Temperature-rise		P
	ambient temperature 10-40 °C .....	22,7 °C	—
	test enclosure W x H x D (mm x mm x mm) .....		—
	material of enclosure .....		—
	Main circuits, test conditions:		—
	- rated operational current $I_e$ (A) .....	10 A	—
	- cable/busbar cross-section (mm <sup>2</sup> ) / length (mm) .....	1,5 mm <sup>2</sup> cables / 1000mm long	—
	Fuse-link details (fuse-combination units only):		—
	- manufacturer's name, trademark or identification mark .....	SIBA	—
	- manufacturer's model or type reference .....	50 179 06.10	—
	- rated current (A) .....	10 A (gR)	—
	- power loss (W) .....	2,3 W	—
	- rated breaking capacity (kA) .....	200 kA	—
	Measured temperature-rise .....	see appended table 8.3.3.1 on page 106	P
	Auxiliary circuits, test conditions:		N/A
	- rated operation current (A) .....		—
	- cable cross-section (mm <sup>2</sup> ) .....		—
	Measured temperature-rise .....	see appended table 8.3.3.1 on page ___	N/A
8.3.3.2	Test of dielectric properties		P
	Rated impulse withstand voltage (kV) .....	6 kV	—
	- test $U_{imp}$ main circuits (kV) .....	7,3 kV	P
	- test $U_{imp}$ auxiliary circuits (kV) .....		N/A
	- test $U_{imp}$ on open main contacts (equipment suitable for isolation) (kV) .....	9,8 kV	P
	Power-frequency withstand voltage (V) .....	800 V	—
	- main circuits, test voltage for 5 sec. (V) .....	2000 V	P
	- control and auxiliary circuits, test voltage for 5 sec. (V) .....		N/A

TRF No. IEC60947\_3B

ВЯРНО С  
ОРИГИНАЛА

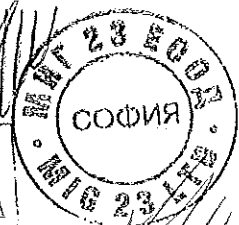

1020

IEC 60947-3			
Clause	Requirement + Test	Result - Remark	Verdict
	Devices, which have been disconnected for the power-frequency withstand voltage test .....		N/A
	Equipment suitable for isolation, leakage current not exceed 0,5 mA		—
	Test voltage 1,1 Ue (V) .....	759 V	—
	Measured leakage current (mA) .....	0,001 mA	P
8.3.3.3	Making and breaking capacity		P
	- utilization category .....	AC-22B	—
	- rated operational voltage Ue (V) .....	690 V	—
	- rated operational current Ie (A) or power (kW) .....	10 A	—
	Fuse-link details (fuse-combination units only):		—
	- manufacturer's name, trademark or identification mark .....	SIBA	—
	- manufacturer's model or type reference .....	50 179 06.10	—
	- rated current (A) .....	10 A (gR)	—
	- power loss (W) .....	2,3 W	—
	- rated breaking capacity (kA) .....	200 kA	—
	Conditions for make/break operations or make operation, AC-23A and AC-23B only:		N/A
	- test voltage, U = 1,05 Ue .....	L1: L2: L3:	—
	- test current, I = ..... x Ie (A):	L1: L2: L3:	—
	- power factor .....	L1: L2: L3:	—
	Conditions for break operation, AC-23A and AC-23B only:		N/A
	- test voltage, U = 1,05 Ue .....	L1: L2: L3:	—
	- test current, I = ..... x Ie (A):	L1: L2: L3:	—
	- power factor .....	L1: L2: L3:	—



IEC 60947-3			
Clause	Requirement + Test	Result - Remark	Verdict
	Conditions for make/break operations, other than AC-23A/B:		
	- test voltage, $U = 1,05 U_e$ ..... (V):	L1: 725 V (418,5 V x $\sqrt{3}$ ) L2: 725 V (418,5 V x $\sqrt{3}$ ) L3: —	—
	- test current, $I =$ ..... 3x $I_e$ (A):	L1: 31 A L2: 31 A L3: —	—
	- power factor/ time constant .....	0,65	—
	Number of make/break or make and break operations .....	5	P
	- recovery voltage duration ( $\geq 50$ ms)	> 50 ms	P
	- current duration (ms) .....	80 ms	—
	- time interval between operations .....	30 s	P
	Characteristic of transient recovery voltage for AC-22 and AC-23 only		P
	- oscillatory frequency (kHz) .....	21,15 kHz	—
	- measured oscillatory frequency (kHz) .....	L1: 21,0 kHz L2: 21,0 kHz L3:	P
	- factor $\gamma$ .....	L1: 1,1 L2: 1,1 L3:	P
8.3.3.3.5	Behaviour of the equipment during making and breaking capacity tests		P
	Test performed without:		—
	- endanger to the operator		P
	- cause damage to adjacent equipment		P
	No permanent arcing		P
	No flash over between poles and poles and frame		P
	No melting of the fuse in the detection circuit		P
8.3.3.3.6	Condition of the equipment after making and breaking capacity tests		P
	Immediately after the test equipment must work satisfactorily		P
	- required opening force not greater than the test force of 8.2.5.2 and table 8	22,5 N (required opening force) 150 N (test force acc. tab. 8)	P
	- equipment is able to carry its rated current after normal closing operation		P



IEC 60947-3			
Clause	Requirement + Test	Result - Remark	Verdict
8.3.3.4	Dielectric verification		P
	test voltage: $2 \cdot U_e$ with a minimum of 1000V~ .....	1380 V	—
	No flashover or breakdown		P
8.3.3.5	Leakage current		P
	test voltage (1,1 $U_e$ ) (V) .....	759 V	—
	Leakage current (utilization categories AC-20A, AC-20B, DC-20A and DC-20B): $\leq 0,5$ mA/pole .....		N/A
	Leakage current (other utilization categories): $\leq 2$ mA/pole) .....	< 2 mA	P
8.3.3.6	Temperature-rise verification		P
	Fuse-link details (fuse-combination units only):		—
	- manufacturer's name, trademark or identification mark .....	SIBA	—
	- manufacturer's model or type reference .....	50 179 06.10	—
	- rated current (A) .....	10 A (gR)	—
	- power loss (W) .....	2,3 W	—
	- rated breaking capacity (kA) .....	200 kA	—
	- conductor cross-section (mm <sup>2</sup> ) .....	1,5 mm <sup>2</sup>	—
	- test current $I_e$ (A) .....	10 A	—
	Measured temperature-rise .....	see appended table 8.3.3.6 on page 107	P
8.3.3.7	Strength of actuator mechanism		P
8.2.5	Verification of the strength of actuator mechanism and position indicating device		—
	- actuator type (fig.) .....	figure 1b (one-finger operated)	—
8.2.5.2.1	Dependent and independent manual operation	dependent manual operation	P
	- actuating force for opening (N) .....	24,4 N	—
	- test force with blocked main contacts (N) .....	73,2 N	—
	- used method to keep the contact closed .....	Fuse-links were held tight with a piece of wire	—
	During and after the test, open position not indicated .....		P
	Equipment with locking mean, no locking in the open position while test force is applied .....		P

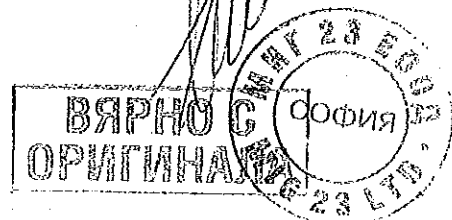



IEC 60947-3			
Clause	Requirement + Test	Result - Remark	Verdict
8.2.5.2.2	Dependent power operation		N/A
	- main contacts fixed together in the closed position:		N/A
	- used method to keep the contact closed .....		N/A
	- 110% of the rated supply voltage applied to the equipment (3 times) .....		N/A
	During and after the test, open position not indicated .....		N/A
	Equipment show no damage impairing its normal operation .....		N/A
	Equipment with locking mean, no locking in the open position while test force is applied .....		N/A
8.2.5.2.3	Independent power operation		N/A
	- main contacts fixed together in the closed position:		N/A
	- used method to keep the contact closed .....		N/A
	- stored energy of the power operator released (3 times) .....		N/A
	During and after the test, open position not indicated .....		N/A
	Equipment show no damage impairing its normal operation .....		N/A
	Equipment with locking mean, no locking in the open position while test force is applied .....		N/A

TRF No. IEC60947\_3B

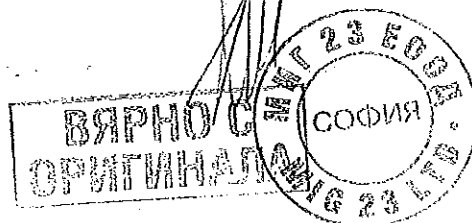

*[Handwritten signature]*

*[Handwritten signature]*  
1029

IEC 60947-3			
Clause	Requirement + Test	Result - Remark	Verdict
8.3.3	TEST SEQUENCE I: GENERAL PERFORMANCE CHARACTERISTICS (Sample No. 7: AC-22B, 690 V, 32 A, 3-pole+N)		P
8.3.3.1	Temperature-rise		P
	ambient temperature 10-40 °C .....	22,7 °C	—
	test enclosure W x H x D (mm x mm x mm) .....		—
	material of enclosure .....		—
	Main circuits, test conditions:		—
	- rated operational current I <sub>e</sub> (A) .....	32 A	—
	- cable/busbar cross-section (mm <sup>2</sup> ) / length (mm) ..	6 mm <sup>2</sup> cables / 1000mm long	—
	Fuse-link details (fuse-combination units only):		—
	- manufacturer's name, trademark or identification mark .....	Bussmann	—
	- manufacturer's model or type reference .....	C10G32	—
	- rated current (A) .....	32 A (gG)	—
	- power loss (W) .....	2,9 W	—
	- rated breaking capacity (kA) .....	120 kA	—
	Measured temperature-rise .....	see appended table 8.3.3.1 on page 107	P
	Auxiliary circuits, test conditions:		N/A
	- rated operation current (A) .....		—
	- cable cross-section (mm <sup>2</sup> ) .....		—
	Measured temperature-rise .....	see appended table 8.3.3.1 on page ___	N/A
8.3.3.2	Test of dielectric properties		P
	Rated impulse withstand voltage (kV) .....	6 kV	—
	- test U <sub>imp</sub> main circuits (kV) .....	7,3 kV	P
	- test U <sub>imp</sub> auxiliary circuits (kV) .....		N/A
	- test U <sub>imp</sub> on open main contacts (equipment suitable for isolation) (kV) .....	9,8 kV	P
	Power-frequency withstand voltage (V) .....	800 V	—
	- main circuits, test voltage for 5 sec. (V) .....	2000 V	P
	- control and auxiliary circuits, test voltage for 5 sec. (V) .....		N/A



IEC 60947-3			
Clause	Requirement + Test	Result - Remark	Verdict
	Devices, which have been disconnected for the power-frequency withstand voltage test .....		N/A
	Equipment suitable for isolation, leakage current not exceed 0,5 mA		—
	Test voltage 1,1 Ue (V) .....	759 V	—
	Measured leakage current (mA) .....	0,001 mA	P
8.3.3.3	Making and breaking capacity		P
	- utilization category .....	AC-22B	—
	- rated operational voltage Ue (V) .....	690 V	—
	- rated operational current Ie (A) or power (kW) .....	32 A	—
	Fuse-link details (fuse-combination units only):		—
	- manufacturer's name, trademark or identification mark .....	Bussmann	—
	- manufacturer's model or type reference .....	C10G32	—
	- rated current (A) .....	32 A (gG)	—
	- power loss (W) .....	2,9 W	—
	- rated breaking capacity (kA) .....	120 kA	—
	Conditions for make/break operations or make operation, AC-23A and AC-23B only:		N/A
	- test voltage, U = 1,05 Ue .....	L1: L2: L3:	—
	- test current, I = ..... x Ie (A):	L1: L2: L3:	—
	- power factor .....	L1: L2: L3:	—
	Conditions for break operation, AC-23A and AC-23B only:		N/A
	- test voltage, U = 1,05 Ue .....	L1: L2: L3:	—
	- test current, I = ..... x Ie (A):	L1: L2: L3:	—
	- power factor .....	L1: L2: L3:	—

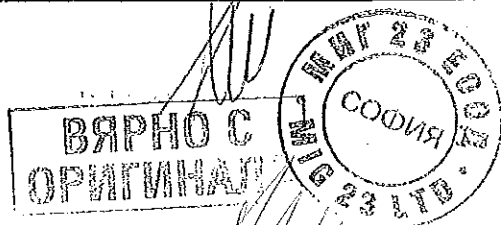

1045

IEC 60947-3			
Clause	Requirement + Test	Result - Remark	Verdict
	Conditions for make/break operations, other than AC-23A/B:		
	- test voltage, $U = 1,05 U_e$ ..... (V):	L1: 725 V (418,5 V x $\sqrt{3}$ ) L2: 725 V (418,5 V x $\sqrt{3}$ ) L3: 725 V (418,5 V x $\sqrt{3}$ )	—
	- test current, $I =$ ..... 3 x $I_e$ (A):	L1: 99 A L2: 98 A L3: 100 A	—
	- power factor/ time constant .....	0,63	—
	Number of make/break or make and break operations .....	5	P
	- recovery voltage duration ( $\geq 50$ ms)	> 50 ms	P
	- current duration (ms) .....	70 ms	—
	- time interval between operations .....	30 s	P
	Characteristic of transient recovery voltage for AC-22 and AC-23 only		P
	- oscillatory frequency (kHz) .....	26,69 kHz	—
	- measured oscillatory frequency (kHz) .....	L1: 27,5 kHz L2: 27,5 kHz L3: 27,5 kHz	P
	- factor $\gamma$ .....	L1: 1,1 L2: 1,1 L3: 1,1	P
8.3.3.3.5	Behaviour of the equipment during making and breaking capacity tests		P
	Test performed without:		—
	- endanger to the operator		P
	- cause damage to adjacent equipment		P
	No permanent arcing		P
	No flash over between poles and poles and frame		P
	No melting of the fuse in the detection circuit		P
8.3.3.3.6	Condition of the equipment after making and breaking capacity tests		P
	Immediately after the test equipment must work satisfactorily		P
	- required opening force not greater than the test force of 8.2.5.2 and table 8	46,2 N (required opening force) 150 N (test force acc. tab. 8)	P
	- equipment is able to carry its rated current after normal closing operation		P



IEC 60947-3			
Clause	Requirement + Test	Result - Remark	Verdict
8.3.3.4	Dielectric verification		P
	test voltage: $2 \cdot U_e$ with a minimum of 1000V~ .....	1380 V	—
	No flashover or breakdown		P
8.3.3.5	Leakage current		P
	test voltage (1,1 $U_e$ ) (V) .....	759 V	—
	Leakage current (utilization categories AC-20A, AC-20B, DC-20A and DC-20B): $\leq 0,5$ mA/pole .....		N/A
	Leakage current (other utilization categories): $\leq 2$ mA/pole) .....	< 2 mA	P
8.3.3.6	Temperature-rise verification		P
	Fuse-link details (fuse-combination units only):		—
	- manufacturer's name, trademark or identification mark .....	Bussmann	—
	- manufacturer's model or type reference .....	C10G32	—
	- rated current (A) .....	32 A (gG)	—
	- power loss (W) .....	2,9 W	—
	- rated breaking capacity (kA) .....	120 kA	—
	- conductor cross-section (mm <sup>2</sup> ) .....	6 mm <sup>2</sup>	—
	- test current $I_e$ (A) .....	32 A	—
	Measured temperature-rise .....	see appended table 8.3.3.6 on page 107	P
8.3.3.7	Strength of actuator mechanism		P
8.2.5	Verification of the strength of actuator mechanism and position indicating device		
	- actuator type (fig.) .....	figure 1b (one-finger operated)	—
8.2.5.2.1	Dependent and independent manual operation	dependent manual operation	P
	- actuating force for opening (N) .....	41,2 N	—
	- test force with blocked main contacts (N) .....	123,6 N	—
	- used method to keep the contact closed .....	Fuse-links were held tight with a piece of wire	—
	During and after the test, open position not indicated .....		P
	Equipment with locking mean, no locking in the open position while test force is applied .....		P



IEC 60947-3			
Clause	Requirement + Test	Result - Remark	Verdict
8.2.5.2.2	Dependent power operation		N/A
	- main contacts fixed together in the closed position:		N/A
	- used method to keep the contact closed .....		N/A
	- 110% of the rated supply voltage applied to the equipment (3 times) .....		N/A
	During and after the test, open position not indicated .....		N/A
	Equipment show no damage impairing its normal operation .....		N/A
	Equipment with locking mean, no locking in the open position while test force is applied .....		N/A
8.2.5.2.3	Independent power operation		N/A
	- main contacts fixed together in the closed position:		N/A
	- used method to keep the contact closed .....		N/A
	- stored energy of the power operator released (3 times) .....		N/A
	During and after the test, open position not indicated .....		N/A
	Equipment show no damage impairing its normal operation .....		N/A
	Equipment with locking mean, no locking in the open position while test force is applied .....		N/A

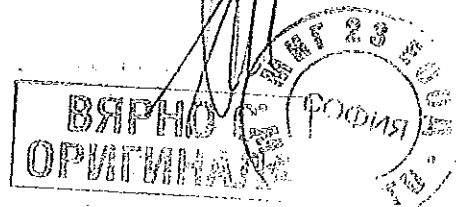

IEC 60947-3			
Clause	Requirement + Test	Result - Remark	Verdict
8.3.4	TEST SEQUENCE II: OPERATIONAL PERFORMANCE CAPABILITY (Sample No. 8: AC-21B, 500 V, 25 A, 1-pole)		P
8.3.4.1	Operational performance test		P
	- utilization category .....	AC-21B	—
	- rated operational voltage (V) .....	500 V	—
	- rated operational current (A) .....	25 A	—
	Test conditions for electrical operation cycles:		
	- test voltage (V) .....	L1: 506 V L2: — L3: —	—
	- test current (A) .....	L1: 25,6 A L2: — L3: —	—
	- power factor/time constant .....	L1: 0,95 L2: — L3: —	—
	Number of cycles with current .....	300	P
	Number of cycles without current .....	1700	P
	First test sequence (with/without current) .....	Without current	—
	Second test sequence (with/without current) .....	With current	—
	- time interval between first and second test sequence .....	515 minutes	—
8.3.4.1.5	Behaviour of the equipment during the operational performance test		P
	Test performed without:		—
	- endanger to the operator		P
	- cause damage to adjacent equipment		P
	No permanent arcing		P
	No flash over between poles and poles and frame		P
	No melting of the fuse in the detection circuit		P



IEC 60947-3			
Clause	Requirement + Test	Result - Remark	Verdict
8.3.4.1.6	Condition of the equipment after making and breaking capacity tests		P
	Immediately after the test equipment must work satisfactorily		P
	- required opening force not greater than the test force of 8.2.5.2 and table 8	11,2 N (required opening force) 150 N (test force acc. tab. 8)	P
	- equipment is able to carry its rated current after normal closing operation		P
8.3.4.2	Dielectric verification		P
	test voltage: $2 \cdot U_e$ with a minimum of 1000V~ .....	1000 V (tested with 1380 V)	—
	No breakdown or flashover		P
8.3.4.3	Leakage current		P
	test voltage (1,1 $U_e$ ) (V) .....	550 V (tested with 759 V)	—
	Leakage current (utilization categories AC-20A, AC-20B, DC-20A and DC-20B) $\leq 0,5$ mA/pole .....		N/A
	Leakage current (other utilization categories) $\leq 2$ mA/pole .....	< 2 mA	P
8.3.4.4	Temperature-rise verification		P
	Fuse-link details (fuse-combination units only):		—
	- manufacturer's name, trademark or identification mark .....	Bussmann	—
	- manufacturer's model or type reference .....	C10G25	—
	- rated current (A) .....	25 A (gG)	—
	- power loss (W) .....	2,6 W	—
	- rated breaking capacity (kA) .....	120 kA	—
	- conductor cross-section (mm <sup>2</sup> ) .....	4 mm <sup>2</sup>	—
	- test current $I_e$ (A) .....	25 A	—
	Measured temperature-rise .....	see appended table 8.3.4.4 on page 108	P



Handwritten signature and date 10/31



IEC 60947-3			
Clause	Requirement + Test	Result - Remark	Verdict
8.3.4	TEST SEQUENCE II: OPERATIONAL PERFORMANCE CAPABILITY (Sample No. 9: AC-21B, 690 V, 10 A, 1-pole)		P
8.3.4.1	Operational performance test		P
	- utilization category .....	AC-21B	—
	- rated operational voltage (V) .....	690 V	—
	- rated operational current (A) .....	10 A	—
	Test conditions for electrical operation cycles:		
	- test voltage (V) .....	L1: 690 V L2: — L3: —	—
	- test current (A) .....	L1: 10,2 A L2: — L3: —	—
	- power factor/time constant .....	L1: 0,95 L2: — L3: —	—
	Number of cycles with current .....	300	P
	Number of cycles without current .....	1700	P
	First test sequence (with/without current) .....	Without current	—
	Second test sequence (with/without current) .....	With current	—
	- time interval between first and second test sequence .....	1125 minutes	—
8.3.4.1.5	Behaviour of the equipment during the operational performance test		P
	Test performed without:		—
	- endanger to the operator		P
	- cause damage to adjacent equipment		P
	No permanent arcing		P
	No flash over between poles and poles and frame		P
	No melting of the fuse in the detection circuit		P

TRF No. IEC60947\_3B



1032

IEC 60947-3			
Clause	Requirement + Test	Result - Remark	Verdict
8.3.4.1.6	Condition of the equipment after making and breaking capacity tests		P
	Immediately after the test equipment must work satisfactorily		P
	- required opening force not greater than the test force of 8.2.5.2 and table 8	8,0 N (required opening force) 150 N (test force acc. tab. 8)	P
	- equipment is able to carry its rated current after normal closing operation		P
8.3.4.2	Dielectric verification		P
	test voltage: $2 \cdot U_e$ with a minimum of 1000V~ .....	1380 V	—
	No breakdown or flashover		P
8.3.4.3	Leakage current		P
	test voltage (1,1 $U_e$ ) (V) .....	759 V	—
	Leakage current (utilization categories AC-20A, AC-20B, DC-20A and DC-20B) $\leq 0,5$ mA/pole .....		N/A
	Leakage current (other utilization categories) $\leq 2$ mA/pole .....	0,005 mA	P
8.3.4.4	Temperature-rise verification		P
	Fuse-link details (fuse-combination units only):		—
	- manufacturer's name, trademark or identification mark .....	SIBA	—
	- manufacturer's model or type reference .....	50 179 06.10	—
	- rated current (A) .....	10 A (gR)	—
	- power loss (W) .....	2,3 W	—
	- rated breaking capacity (kA) .....	200 kA	—
	- conductor cross-section (mm <sup>2</sup> ) .....	1,5 mm <sup>2</sup>	—
	- test current $I_e$ (A) .....	10 A	—
	Measured temperature-rise .....	see appended table 8.3.4.4 on page 108	P



*[Handwritten signature]*

10733

IEC 60947-3			
Clause	Requirement + Test	Result - Remark	Verdict
8.3.4	TEST SEQUENCE II: OPERATIONAL PERFORMANCE CAPABILITY (Sample No. 10: AC-22B, 400 V, 32 A, 1-pole)		P
8.3.4.1	Operational performance test		P
	- utilization category .....	AC-22B	—
	- rated operational voltage (V) .....	400 V	—
	- rated operational current (A) .....	32 A	—
	Test conditions for electrical operation cycles:		
	- test voltage (V) .....	L1: 414 V L2: L3: —	—
	- test current (A) .....	L1: 32,1 A L2: L3: —	—
	- power factor/time-constant .....	L1: 0,79 L2: L3: —	—
	Number of cycles with current .....	300	P
	Number of cycles without current .....	1700	P
	First test sequence (with/without current) .....	Without current	—
	Second test sequence (with/without current) .....	With current	—
	- time interval between first and second test sequence .....	315 minutes	—
8.3.4.1.5	Behaviour of the equipment during the operational performance test		P
	Test performed without:		—
	- endanger to the operator		P
	- cause damage to adjacent equipment		P
	No permanent arcing		P
	No flash over between poles and poles and frame		P
	No melting of the fuse in the detection circuit		P



IEC 60947-3			
Clause	Requirement + Test	Result - Remark	Verdict
8.3.4.1.6	Condition of the equipment after making and breaking capacity tests		P
	Immediately after the test equipment must work satisfactorily		P
	- required opening force not greater than the test force of 8.2.5.2 and table 8	11,4 N (required opening force) 150 N (test force acc. tab. 8)	P
	- equipment is able to carry its rated current after normal closing operation		P
8.3.4.2	Dielectric verification		P
	test voltage: $2 \cdot U_e$ with a minimum of 1000V~ .....	1000 V (tested with 1380 V)	—
	No breakdown or flashover		P
8.3.4.3	Leakage current		P
	test voltage (1,1 $U_e$ ) (V) .....	440 V (tested with 759 V)	—
	Leakage current (utilization categories AC-20A, AC-20B, DC-20A and DC-20B) $\leq 0,5$ mA/pole .....		N/A
	Leakage current (other utilization categories) $\leq 2$ mA/pole .....	0,006 mA	P
8.3.4.4	Temperature-rise verification		P
	Fuse-link details (fuse-combination units only):		—
	- manufacturer's name, trademark or identification mark .....	Bussmann	—
	- manufacturer's model or type reference .....	C10G32	—
	- rated current (A) .....	32 A (gG)	—
	- power loss (W) .....	2,9 W	—
	- rated breaking capacity (kA) .....	120 kA	—
	- conductor cross-section (mm <sup>2</sup> ) .....	6 mm <sup>2</sup>	—
	- test current $I_e$ (A) .....	32 A	—
	Measured temperature-rise .....	see appended table 8.3.4.4 on page 108	P



IEC 60947-3			
Clause	Requirement + Test	Result - Remark	Verdict
8.3.4	TEST SEQUENCE II: OPERATIONAL PERFORMANCE CAPABILITY (Sample No. 11: AC-22B, 400 V, 32 A, 2-poles)		P
8.3.4.1	Operational performance test		P
	- utilization category .....	AC-22B	—
	- rated operational voltage (V) .....	400 V	—
	- rated operational current (A) .....	32 A	—
	Test conditions for electrical operation cycles:		
	- test voltage (V) .....	L1: 414 V (239 V x $\sqrt{3}$ ) L2: 414 V (239 V x $\sqrt{3}$ ) L3: —	—
	- test current (A) .....	L1: 32,2 A L2: 32,2 A L3: —	—
	- power factor/time constant .....	L1: 0,8 L2: 0,8 L3: —	—
	Number of cycles with current .....	300	P
	Number of cycles without current .....	1700	P
	First test sequence (with/without current) .....	Without current	—
	Second test sequence (with/without current) .....	With current	—
	- time interval between first and second test sequence .....	315 minutes	—
8.3.4.1.5	Behaviour of the equipment during the operational performance test		P
	Test performed without:		—
	- endanger to the operator		P
	- cause damage to adjacent equipment		P
	No permanent arcing		P
	No flash over between poles and poles and frame		P
	No melting of the fuse in the detection circuit		P



IEC 60947-3			
Clause	Requirement + Test	Result - Remark	Verdict
8.3.4.1.6	Condition of the equipment after making and breaking capacity tests		P
	Immediately after the test equipment must work satisfactorily		P
	- required opening force not greater than the test force of 8.2.5.2 and table 8	21,4 N (required opening force) 150 N (test force acc. tab. 8)	P
	- equipment is able to carry its rated current after normal closing operation		P
8.3.4.2	Dielectric verification		P
	test voltage: $2 \cdot U_e$ with a minimum of 1000V~ .....	1000 V (tested with 1380 V)	—
	No breakdown or flashover		P
8.3.4.3	Leakage current		P
	test voltage (1,1 $U_e$ ) (V) .....	440 V (tested with 759 V)	—
	Leakage current (utilization categories AC-20A, AC-20B, DC-20A and DC-20B) $\leq 0,5$ mA/pole .....		N/A
	Leakage current (other utilization categories) $\leq 2$ mA/pole .....	0,006 mA	P
8.3.4.4	Temperature-rise verification		P
	Fuse-link details (fuse-combination units only):		—
	- manufacturer's name, trademark or identification mark .....	Bussmann	—
	- manufacturer's model or type reference .....	C10G32	—
	- rated current (A) .....	32 A (gG)	—
	- power loss (W) .....	2,9 W	—
	- rated breaking capacity (kA) .....	120 kA	—
	- conductor cross-section (mm <sup>2</sup> ) .....	6 mm <sup>2</sup>	—
	- test current $I_e$ (A) .....	32 A	—
	Measured temperature-rise .....	see appended table 8.3.4.4 on page 109	P



IEC 60947-3			
Clause	Requirement + Test	Result - Remark	Verdict
8.3.4	TEST SEQUENCE II: OPERATIONAL PERFORMANCE CAPABILITY (Sample No. 12: AC-22B, 500 V, 25 A, 2-poles)		P
8.3.4.1	Operational performance test		P
	- utilization category .....	AC-22B	—
	- rated operational voltage (V) .....	500 V	—
	- rated operational current (A) .....	25 A	—
	Test conditions for electrical operation cycles:		
	- test voltage (V) .....	L1: 510 V (294,4 V x √3) L2: 510 V (294,4 V x √3) L3:—	—
	- test current (A) .....	L1: 24,9 A L2: 24,9 A L3: —	—
	- power factor/time constant .....	L1: 0,78 L2: 0,78 L3: —	—
	Number of cycles with current .....	300	P
	Number of cycles without current .....	1700	P
	First test sequence (with/without current) .....	Without current	—
	Second test sequence (with/without current) .....	With current	—
	- time interval between first and second test sequence .....	315 minutes	—
8.3.4.1.5	Behaviour of the equipment during the operational performance test		P
	Test performed without:		—
	- endanger to the operator		P
	- cause damage to adjacent equipment		P
	No permanent arcing		P
	No flash over between poles and poles and frame		P
	No melting of the fuse in the detection circuit		P



IEC 60947-3			
Clause	Requirement + Test	Result - Remark	Verdict
8.3.4.1.6	Condition of the equipment after making and breaking capacity tests		P
	Immediately after the test equipment must work satisfactorily		P
	- required opening force not greater than the test force of 8.2.5.2 and table 8	21,6 N (required opening force) 150 N (test force acc. tab. 8)	P
	- equipment is able to carry its rated current after normal closing operation		P
8.3.4.2	Dielectric verification		P
	test voltage: $2 \cdot U_e$ with a minimum of 1000V~ .....	1000 V (tested with 1380 V)	—
	No breakdown or flashover		P
8.3.4.3	Leakage current		P
	test voltage (1,1 $U_e$ ) (V) .....	550 V (tested with 759 V)	—
	Leakage current (utilization categories AC-20A, AC-20B, DC-20A and DC-20B) $\leq 0,5$ mA/pole .....		N/A
	Leakage current (other utilization categories) $\leq 2$ mA/pole .....	< 2 mA	P
8.3.4.4	Temperature-rise verification		P
	Fuse-link details (fuse-combination units only):		—
	- manufacturer's name, trademark or identification mark .....	Bussmann	—
	- manufacturer's model or type reference .....	C10G25	—
	- rated current (A) .....	25 A (gG)	—
	- power loss (W) .....	2,6 W	—
	- rated breaking capacity (kA) .....	120 kA	—
	- conductor cross-section (mm <sup>2</sup> ) .....	4 mm <sup>2</sup>	—
	- test current $I_e$ (A) .....	25 A	—
	Measured temperature-rise .....	see appended table 8.3.4.4 on page 109	P





IEC 60947-3			
Clause	Requirement + Test	Result - Remark	Verdict
8.3.4	TEST SEQUENCE II: OPERATIONAL PERFORMANCE CAPABILITY (Sample No. 13: AC-22B, 690 V, 10 A, 2-poles)		P
8.3.4.1	Operational performance test		P
	- utilization category .....	AC-22B	—
	- rated operational voltage (V) .....	690 V	—
	- rated operational current (A) .....	10 A	—
	Test conditions for electrical operation cycles:		
	- test voltage (V) .....	L1: 690 V (398,4 V x √3) L2: 690 V (398,4 V x √3) L3:—	—
	- test current (A) .....	L1: 10 A L2: 10 A L3: —	—
	- power factor/time constant .....	L1: 0,78 L2: 0,78 L3: —	—
	Number of cycles with current .....	300	P
	Number of cycles without current .....	1700	P
	First test sequence (with/without current) .....	Without current	—
	Second test sequence (with/without current) .....	With current	—
	- time interval between first and second test sequence .....	315 minutes	—
8.3.4.1.5	Behaviour of the equipment during the operational performance test		P
	Test performed without:		—
	- endanger to the operator		P
	- cause damage to adjacent equipment		P
	No permanent arcing		P
	No flash over between poles and poles and frame		P
	No melting of the fuse in the detection circuit		P



IEC 60947-3			
Clause	Requirement + Test	Result - Remark	Verdict
8.3.4.1.6	Condition of the equipment after making and breaking capacity tests		P
	Immediately after the test equipment must work satisfactorily		P
	- required opening force not greater than the test force of 8.2.5.2 and table 8	21,8 N (required opening force) 150 N (test force acc. tab. 8)	P
	- equipment is able to carry its rated current after normal closing operation		P
8.3.4.2	Dielectric verification		P
	test voltage: $2 \cdot U_e$ with a minimum of 1000V~ .....	1380 V	—
	No breakdown or flashover		P
8.3.4.3	Leakage current		P
	test voltage (1,1 $U_e$ ) (V) .....	759 V	—
	Leakage current (utilization categories AC-20A, AC-20B, DC-20A and DC-20B) $\leq 0,5$ mA/pole .....		N/A
	Leakage current (other utilization categories) $\leq 2$ mA/pole .....	0,008 mA	P
8.3.4.4	Temperature-rise verification		P
	Fuse-link details (fuse-combination units only):		—
	- manufacturer's name, trademark or identification mark .....	SIBA	—
	- manufacturer's model or type reference .....	50 179 06.10	—
	- rated current (A) .....	10 A (gR)	—
	- power loss (W) .....	2,3 W	—
	- rated breaking capacity (kA) .....	200 kA	—
	- conductor cross-section (mm <sup>2</sup> ) .....	1,5 mm <sup>2</sup>	—
	- test current $I_e$ (A) .....	10 A	—
	Measured temperature-rise .....	see appended table 8.3.4.4 on page 109	P



IEC 60947-3			
Clause	Requirement + Test	Result - Remark	Verdict
8.3.4	TEST SEQUENCE II: OPERATIONAL PERFORMANCE CAPABILITY (Sample No. 14: AC-22B, 690 V, 32 A, 3-poles+N)		P
8.3.4.1	Operational performance test		P
	- utilization category .....	AC-22B	—
	- rated operational voltage (V) .....	690 V	—
	- rated operational current (A) .....	32 A	—
	Test conditions for electrical operation cycles:		
	- test voltage (V) .....	L1: 690 V (398,4 V x √3) L2: 690 V (398,4 V x √3) L3: 690 V (398,4 V x √3)	—
	- test current (A) .....	L1: 33 A L2: 33 A L3: 33 A	—
	- power factor/time constant .....	L1: 0,8 L2: 0,8 L3: 0,8	—
	Number of cycles with current .....	300	P
	Number of cycles without current .....	1700	P
	First test sequence (with/without current) .....	Without current	—
	Second test sequence (with/without current) .....	With current	—
	- time interval between first and second test sequence .....	315 minutes	—
8.3.4.1.5	Behaviour of the equipment during the operational performance test		P
	Test performed without:		—
	- endanger to the operator		P
	- cause damage to adjacent equipment		P
	No permanent arcing		P
	No flash over between poles and poles and frame		P
	No melting of the fuse in the detection circuit		P

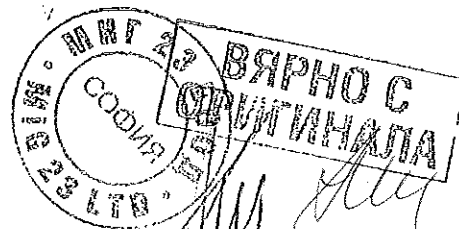

IEC 60947-3			
Clause	Requirement + Test	Result - Remark	Verdict
8.3.4.1.6	Condition of the equipment after making and breaking capacity tests		P
	Immediately after the test equipment must work satisfactorily		P
	- required opening force not greater than the test force of 8.2.5.2 and table 8	44,6 N (required opening force) 150 N (test force acc. tab. 8)	P
	- equipment is able to carry its rated current after normal closing operation		P
8.3.4.2	Dielectric verification		P
	test voltage: $2 \cdot U_e$ with a minimum of 1000V~ .....	1380 V	—
	No breakdown or flashover		P
8.3.4.3	Leakage current		P
	test voltage (1,1 $U_e$ ) (V) .....	759 V	—
	Leakage current (utilization categories AC-20A, AC-20B, DC-20A and DC-20B) $\leq 0,5$ mA/pole .....		N/A
	Leakage current (other utilization categories) $\leq 2$ mA/pole .....	0,01 mA	P
8.3.4.4	Temperature-rise verification		P
	Fuse-link details (fuse-combination units only):		—
	- manufacturer's name, trademark or identification mark .....	Bussmann	—
	- manufacturer's model or type reference .....	C10G32	—
	- rated current (A) .....	32 A (gG)	—
	- power loss (W) .....	2,9 W	—
	- rated breaking capacity (kA) .....	120 kA	—
	- conductor cross-section (mm <sup>2</sup> ) .....	6 mm <sup>2</sup>	—
	- test current $I_e$ (A) .....	32 A	—
	Measured temperature-rise .....	see appended table 8.3.4.4 on page 110	P



IEC 60947-3			
Clause	Requirement + Test	Result - Remark	Verdict
8.3.5	TEST SEQUENCE III: SHORT-CIRCUIT PERFORMANCE CAPABILITY		N/A
8.3.5.1	Short-time withstand current test		N/A
	Rated short-time withstand current $I_{cw}$ (A) ( $>12 \cdot I_e \text{ max}$ ) .....		N/A
	test voltage (V) .....	L1: L2: L3:	—
	r.m.s. test current (A) .....	L1: L2: L3:	—
	peak test current (A) .....	L1: L2: L3:	—
	power factor/time constant .....	L1: L2: L3:	—
	test duration (s) .....		—
8.3.5.1.5	Behaviour of the equipment during the test		N/A
	Test performed without:		—
	- endanger to the operator		N/A
	- cause damage to adjacent equipment		N/A
	No permanent arcing		N/A
	No flash over between poles and poles and frame		N/A
	No melting of the fuse in the detection circuit		N/A
8.3.5.1.6	Condition of the equipment after making and breaking capacity tests		N/A
	Immediately after the test equipment must work satisfactorily		N/A
	- required opening force not greater than the test force of 8.2.5.2 and table 8		N/A
	- equipment is able to carry its rated current after normal closing operation		N/A



IEC 60947-3			
Clause	Requirement + Test	Result - Remark	Verdict
8.3.5.2	Short-circuit making capacity		N/A
	Rated short-circuit making capacity I <sub>cm</sub> (A) .....		N/A
	test voltage (1.05xU <sub>e</sub> ) ..... (V):	L1: L2: L3:	—
	r.m.s. test current (A) .....	L1: L2: L3:	—
	maximum peak test current (factor n)		N/A
	power factor/time constant .....	L1: L2: L3:	N/A
	current duration (s) .....		—
	Time interval between the cycles		—
8.3.5.2.5	Behaviour of the equipment during the test		N/A
	Test performed without:		—
	- endanger to the operator		N/A
	- cause damage to adjacent equipment		N/A
	No permanent arcing		N/A
	No flash over between poles and poles and frame		N/A
	No melting of the fuse in the detection circuit		N/A
8.3.5.2.6	Condition of the equipment after making and breaking capacity tests		N/A
	Immediately after the test equipment must work satisfactorily		N/A
	- required opening force not greater than the test force of 8.2.5.2 and table 8		N/A
	- equipment is able to carry its rated current after normal closing operation		N/A
8.3.5.3	Dielectric verification		N/A
	test voltage: 2*U <sub>e</sub> with a minimum of 1000V~ .....		—
	No flashover or breakdown		N/A



IEC 60947-3			
Clause	Requirement + Test	Result - Remark	Verdict
8.3.5.4	Leakage current		N/A
	test voltage (1,1 Ue) (V) .....		—
	Leakage current (utilization categories AC-20A, AC-20B, DC-20A and DC-20B) ≤ 0,5 mA/pole .....		N/A
	Leakage current (other utilization categories) ≤ 2,0 mA/pole .....		N/A
8.3.5.5	Temperature-rise verification		N/A
	Fuse-link details (fuse-combination units only):		—
	- manufacturer's name, trademark or identification mark .....		—
	- manufacturer's model or type reference .....		—
	- rated current (A) .....		—
	- power loss (W) .....		—
	- rated breaking capacity (kA) .....		—
	- conductor cross-section (mm <sup>2</sup> ) .....		—
	- test current I <sub>e</sub> (A) .....		—
	Measured temperature-rise .....	see appended table 8.3.5.5 on page __	N/A



IEC 60947-3			
Clause	Requirement + Test	Result - Remark	Verdict
8.3.6	TEST SEQUENCE IV: CONDITIONAL SHORT-CIRCUIT CURRENT (Sample No. 15: 400 V, 32 A, 1-pole)		P
	Protective device details:		P
	- manufacturer's name, trademark or identification mark .....	Bussmann	—
	- manufacturer's model or type reference .....	C10G32	—
	- rated voltage (V) .....	400 V	—
	- rated current (A) .....	32 A (gG)	—
	- rated breaking capacity (kA) .....	120 kA	—
8.3.6.2	Fuse protected short-circuit withstand		P
	test voltage (1,05 Ue) (V) .....	L1: 420 V L2: — L3: —	—
	test current (kA) .....	L1: 101 kA L2: — L3: —	—
	rated frequency (Hz) .....	50 Hz	—
	power factor .....	0,19	—
	Time constant (ms) .....	—	—
	Fuse protected short-circuit withstand (equipment in closed position)		
	- max. let-through current (kA) .....	L1: 6,5 kA L2: — L3: —	—
	- Joule integral I <sup>2</sup> dt (A <sup>2</sup> s) .....	L1: 7000 A <sup>2</sup> s L2: — L3: —	—
	Fuse protected short-circuit making		P
	- mean velocity of 15 manually under no-load conditions operations (m/s) .....	1,6 m/s	—
	- point at which the measurement is made .....	point of rotation	—
	- test speed during the fuse protected short-circuit making (m/s) .....	1,5 m/s	—
	- max. let-through current (kA) .....	L1: 4,94 kA L2: — L3: —	—
	- Joule integral I <sup>2</sup> dt (A <sup>2</sup> s) .....	L1: 5000 A <sup>2</sup> s L2: — L3: —	—

ВЯРНО С  
ОРИГИНАЛА

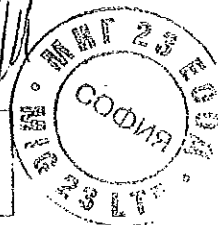



IEC 60947-3			
Clause	Requirement + Test	Result - Remark	Verdict
8.3.6.2.5	Behaviour of the equipment during the test		P
	Test performed without:		—
	- endanger to the operator		P
	- cause damage to adjacent equipment		P
	No permanent arcing		P
	No flash over between poles and poles and frame		P
	No melting of the fuse in the detection circuit		P
8.3.6.2.6	Condition of the equipment after making and breaking capacity tests		P
	Immediately after the test equipment must work satisfactorily		P
	- required opening force not greater than the test force of 8.2.5.2 and table 8	8,7 N (required opening force) 150 N (test force acc. tab. 8)	P
	- equipment is able to carry its rated current after normal closing operation		P
8.3.6.3	Dielectric verification		P
	test voltage: $2 \cdot U_e$ with a minimum of 1000V~ .....	1000 V (tested with 1380 V)	—
	No flashover or breakdown		P
8.3.6.4	Leakage current		P
	test voltage (1,1 $U_e$ ) (V) .....	440 V (tested with 759 V)	—
	Leakage current (utilization categories AC-20A, AC-20B, DC-20A and DC-20B) $\leq 0,5$ mA/pole .....		N/A
	Leakage current (other utilization categories) $\leq 2,0$ mA/pole .....	0,008 mA	P
8.3.6.5	Temperature-rise verification		P
	Fuse-link details (fuse-combination units only):		—
	- manufacturer's name, trademark or identification mark .....	Bussmann	—
	- manufacturer's model or type reference .....	C10G32	—
	- rated current (A) .....	32 A (gG)	—
	- power loss (W) .....	2,9 W	—
	- rated breaking capacity (kA) .....	120 kA	—
	- conductor cross-section (mm <sup>2</sup> ) .....	6 mm <sup>2</sup>	—
	- test current $I_e$ (A) .....	32 A	—
	Measured temperature-rise .....	see appended table 8.3.6.5 on page 110	P

IEC 60947-3			
Clause	Requirement + Test	Result - Remark	Verdict
8.3.6	TEST SEQUENCE IV: CONDITIONAL SHORT-CIRCUIT CURRENT (Sample No. 16: 400 V, 32 A, 1-pole+N)		P
	Protective device details:		P
	- manufacturer's name, trademark or identification mark .....	Bussmann	—
	- manufacturer's model or type reference .....	C10G32	—
	- rated voltage (V) .....	400 V	—
	- rated current (A) .....	32 A (gG)	—
	- rated breaking capacity (kA) .....	120 kA	—
8.3.6.2	Fuse protected short-circuit withstand		P
	test voltage (1,05 Ue) (V) .....	L1: 420 V L2: — L3: —	—
	test current (kA) .....	L1: 101 kA L2: — L3: —	—
	rated frequency (Hz) .....	50 Hz	—
	power factor .....	0,19	—
	Time constant (ms) .....	—	—
	Fuse protected short-circuit withstand (equipment in closed position)		
	- max. let-through current (kA) .....	L1: 6,54 kA L2: — L3: —	—
	- Joule integral I <sup>2</sup> dt (A <sup>2</sup> s) .....	L1: 7000 A <sup>2</sup> s L2: — L3: —	—
	Fuse protected short-circuit making		P
	- mean velocity of 15 manually under no-load conditions operations (m/s) .....	1,6 m/s	—
	- point at which the measurement is made .....	point of rotation	—
	- test speed during the fuse protected short-circuit making (m/s) .....	1,5 m/s	—
	- max. let-through current (kA) .....	L1: 3,7 kA L2: — L3: —	—
	- Joule integral I <sup>2</sup> dt (A <sup>2</sup> s) .....	L1: 4000 A <sup>2</sup> s L2: — L3: —	—

ВЯРНО С  
ОРИГИНАЛА

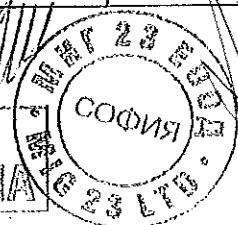

IEC 60947-3			
Clause	Requirement + Test	Result - Remark	Verdict
8.3.6.2.5	Behaviour of the equipment during the test		P
	Test performed without:		—
	- endanger to the operator		P
	- cause damage to adjacent equipment		P
	No permanent arcing		P
	No flash over between poles and poles and frame		P
	No melting of the fuse in the detection circuit		P
8.3.6.2.6	Condition of the equipment after making and breaking capacity tests		P
	Immediately after the test equipment must work satisfactorily		P
	- required opening force not greater than the test force of 8.2.5.2 and table 8	24,8 N (required opening force) 150 N (test force acc. tab. 8)	P
	- equipment is able to carry its rated current after normal closing operation		P
8.3.6.3	Dielectric verification		P
	test voltage: $2 \cdot U_e$ with a minimum of 1000V~ .....	1000 V (tested with 1380 V)	—
	No flashover or breakdown		P
8.3.6.4	Leakage current		P
	test voltage (1,1 $U_e$ ) (V) .....	440 V (tested with 759 V)	—
	Leakage current (utilization categories AC-20A, AC-20B, DC-20A and DC-20B) $\leq 0,5$ mA/pole .....		N/A
	Leakage current (other utilization categories) $\leq 2,0$ mA/pole .....	0,002 mA	P
8.3.6.5	Temperature-rise verification		P
	Fuse-link details (fuse-combination units only):		—
	- manufacturer's name, trademark or identification mark .....	Bussmann	—
	- manufacturer's model or type reference .....	C10G32	—
	- rated current (A) .....	32 A (gG)	—
	- power loss (W) .....	2,9 W	—
	- rated breaking capacity (kA) .....	120 kA	—
	- conductor cross-section (mm <sup>2</sup> ) .....	6 mm <sup>2</sup>	—
	- test current $I_e$ (A) .....	32 A	—
	Measured temperature-rise .....	see appended table 8.3.6.5 on page 111	P

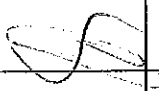
IEC 60947-3			
Clause	Requirement + Test	Result - Remark	Verdict
8.3.6	TEST SEQUENCE IV: CONDITIONAL SHORT-CIRCUIT CURRENT (Sample No. 17: 400 V, 32 A, 2-poles)		P
	Protective device details:		P
	- manufacturer's name, trademark or identification mark .....	Bussmann	—
	- manufacturer's model or type reference .....	C10G32	—
	- rated voltage (V) .....	400 V	—
	- rated current (A) .....	32 A (gG)	—
	- rated breaking capacity (kA) .....	120 kA	—
8.3.6.2	Fuse protected short-circuit withstand		P
	test voltage (1,05 Ue) (V) .....	L1: 420 V (242,5 V x $\sqrt{3}$ ) L2: 420 V (242,5 V x $\sqrt{3}$ ) L3: —	—
	test current (kA) .....	L1: 101 kA L2: 101 kA L3: —	—
	rated frequency (Hz) .....	50 Hz	—
	power factor .....	0,19	—
	Time constant (ms) .....	—	—
	Fuse protected short-circuit withstand (equipment in closed position)		—
	- max. let-through current (kA) .....	L1: 6,35 kA L2: — L3: —	—
	- Joule integral I <sup>2</sup> dt (A <sup>2</sup> s) .....	L1: 5000 A <sup>2</sup> s L2: — L3: —	—
	Fuse protected short-circuit making		P
	- mean velocity of 15 manually under no-load conditions operations (m/s) .....	1,6 m/s	—
	- point at which the measurement is made .....	point of rotation	—
	- test speed during the fuse protected short-circuit making (m/s) .....	1,5 m/s	—
	- max. let-through current (kA) .....	L1: 6,15 kA L2: — L3: —	—
	- Joule integral I <sup>2</sup> dt (A <sup>2</sup> s) .....	L1: 5000 A <sup>2</sup> s L2: — L3: —	—

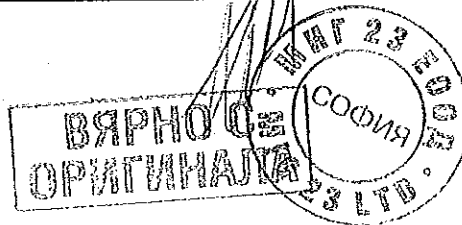

IEC 60947-3			
Clause	Requirement + Test	Result - Remark	Verdict
8.3.6.2.5	Behaviour of the equipment during the test		P
	Test performed without:		—
	- endanger to the operator		P
	- cause damage to adjacent equipment		P
	No permanent arcing		P
	No flash over between poles and poles and frame		P
	No melting of the fuse in the detection circuit		P
8.3.6.2.6	Condition of the equipment after making and breaking capacity tests		P
	Immediately after the test equipment must work satisfactorily		P
	- required opening force not greater than the test force of 8.2.5.2 and table 8	22 N (required opening force) 150 N (test force acc. tab. 8)	P
	- equipment is able to carry its rated current after normal closing operation		P
8.3.6.3	Dielectric verification		P
	test voltage: $2 \cdot U_e$ with a minimum of 1000V~ .....	1000 V (tested with 1380 V)	—
	No flashover or breakdown		P
8.3.6.4	Leakage current		P
	test voltage (1,1 $U_e$ ) (V) .....	440 V (tested with 759 V)	—
	Leakage current (utilization categories AC-20A, AC-20B, DC-20A and DC-20B) $\leq 0,5$ mA/pole .....		N/A
	Leakage current (other utilization categories) $\leq 2,0$ mA/pole .....	0,001 mA	P
8.3.6.5	Temperature-rise verification		P
	Fuse-link details (fuse-combination units only):		—
	- manufacturer's name, trademark or identification mark .....	Bussmann	—
	- manufacturer's model or type reference .....	C10G32	—
	- rated current (A) .....	32 A (gG)	—
	- power loss (W) .....	2,9 W	—
	- rated breaking capacity (kA) .....	120 kA	—
	- conductor cross-section (mm <sup>2</sup> ) .....	6 mm <sup>2</sup>	—
	- test current $I_e$ (A) .....	32 A	—
	Measured temperature-rise .....	see appended table 8.3.6.5 on page 111	P

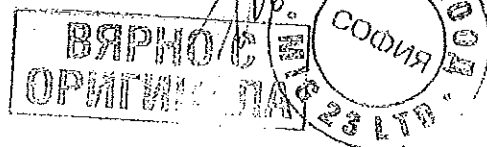

IEC 60947-3			
Clause	Requirement + Test	Result - Remark	Verdict
8.3.6	TEST SEQUENCE IV: CONDITIONAL SHORT-CIRCUIT CURRENT (Sample No. 18: 400 V, 32 A, 3-poles+N)		P
	Protective device details:		P
	- manufacturer's name, trademark or identification mark .....	Bussmann	—
	- manufacturer's model or type reference .....	C10G32	—
	- rated voltage (V) .....	400 V	—
	- rated current (A) .....	32 A (gG)	—
	- rated breaking capacity (kA) .....	120 kA	—
8.3.6.2	Fuse protected short-circuit withstand		P
	test voltage (1,05 Ue) (V) .....	L1: 420 V (242,5 V x √3) L2: 420 V (242,5 V x √3) L3: 420 V (242,5 V x √3)	—
	test current (kA) .....	L1: 103 kA L2: 100 kA L3: 101 kA	—
	rated frequency (Hz) .....	50 Hz	—
	power factor .....	0,19	—
	Time constant (ms) .....	—	—
	Fuse protected short-circuit withstand (equipment in closed position)		
	- max. let-through current (kA) .....	L1: 0,4 kA L2: 4,8 kA L3: 4,8 kA	—
	- Joule Integral I²dt (A²s) .....	L1: 0 A²s L2: 4000 A²s L3: 4000 A²s	—
	Fuse protected short-circuit making		P
	- mean velocity of 15 manually under no-load conditions operations (m/s) .....	1,6 m/s	—
	- point at which the measurement is made .....	point of rotation	—
	- test speed during the fuse protected short-circuit making (m/s) .....	1,5 m/s	—
	- max. let-through current (kA) .....	L1: 1,6 kA L2: 4,2 kA L3: 4,4 kA	—
	- Joule integral I²dt (A²s) .....	L1: 0 A²s L2: 4000 A²s L3: 4000 A²s	—



102

IEC 60947-3			
Clause	Requirement + Test	Result - Remark	Verdict
8.3.6.2.5	Behaviour of the equipment during the test		P
	Test performed without:		—
	- endanger to the operator		P
	- cause damage to adjacent equipment		P
	No permanent arcing		P
	No flash over between poles and poles and frame		P
	No melting of the fuse in the detection circuit		P
8.3.6.2.6	Condition of the equipment after making and breaking capacity tests		P
	Immediately after the test equipment must work satisfactorily		P
	- required opening force not greater than the test force of 8.2.5.2 and table 8	49,1 N (required opening force) 150 N (test force acc. tab. 8)	P
	- equipment is able to carry its rated current after normal closing operation		P
8.3.6.3	Dielectric verification		P
	test voltage: $2 \cdot U_e$ with a minimum of 1000V~ .....	1000 V (tested with 1380 V)	—
	No flashover or breakdown		P
8.3.6.4	Leakage current		P
	test voltage (1,1 $U_e$ ) (V) .....	440 V (tested with 759 V)	—
	Leakage current (utilization categories AC-20A, AC-20B, DC-20A and DC-20B) $\leq 0,5$ mA/pole .....		N/A
	Leakage current (other utilization categories) $\leq 2,0$ mA/pole .....	0,001 mA	P
8.3.6.5	Temperature-rise verification		P
	Fuse-link details (fuse-combination units only):		—
	- manufacturer's name, trademark or identification mark .....	Bussmann	—
	- manufacturer's model or type reference .....	C10G32	—
	- rated current (A) .....	32 A (gG)	—
	- power loss (W) .....	2,9 W	—
	- rated breaking capacity (kA) .....	120 kA	—
	- conductor cross-section (mm <sup>2</sup> ) .....	6 mm <sup>2</sup>	—
	- test current $I_e$ (A) .....	32 A	—
	Measured temperature-rise .....	see appended table 8.3.6.5 on page 111	P

TRF No. IEC60947\_3B



IEC 60947-3			
Clause	Requirement + Test	Result - Remark	Verdict
8.3.6	TEST SEQUENCE IV: CONDITIONAL SHORT-CIRCUIT CURRENT (Sample No. 19: 500 V, 25 A, 1-pole)		P
	Protective device details:		P
	- manufacturer's name, trademark or identification mark .....	Bussmann	—
	- manufacturer's model or type reference .....	C10G25	—
	- rated voltage (V) .....	500 V	—
	- rated current (A) .....	25 A (gG)	—
	- rated breaking capacity (kA) .....	120 kA	—
8.3.6.2	Fuse protected short-circuit withstand		P
	test voltage (1,05 Ue) (V) .....	L1: 537 V L2: — L3: —	—
	test current (kA) .....	L1: 107 kA L2: — L3: —	—
	rated frequency (Hz) .....	50 Hz	—
	power factor .....	0,2	—
	Time constant (ms) .....	—	—
	Fuse protected short-circuit withstand (equipment in closed position)		
	- max. let-through current (kA) .....	L1: 2,59 kA L2: — L3: —	—
	- Joule integral I <sup>2</sup> dt (A <sup>2</sup> s) .....	L1: 1000 A <sup>2</sup> s L2: — L3: —	—
	Fuse protected short-circuit making		P
	- mean velocity of 15 manually under no-load conditions operations (m/s) .....	1,6 m/s	—
	- point at which the measurement is made .....	point of rotation	—
	- test speed during the fuse protected short-circuit making (m/s) .....	1,5 m/s	—
	- max. let-through current (kA) .....	L1: 3,56 kA L2: — L3: —	—
	- Joule integral I <sup>2</sup> dt (A <sup>2</sup> s) .....	L1: 2000 A <sup>2</sup> s L2: — L3: —	—

ВРНО С  
ОРИГИНАЛ

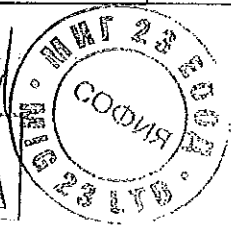

*[Handwritten signature]*



IEC 60947-3			
Clause	Requirement + Test	Result - Remark	Verdict
8.3.6.2.5	Behaviour of the equipment during the test		P
	Test performed without:		—
	- endanger to the operator		P
	- cause damage to adjacent equipment		P
	No permanent arcing		P
	No flash over between poles and poles and frame		P
	No melting of the fuse in the detection circuit		P
8.3.6.2.6	Condition of the equipment after making and breaking capacity tests		P
	Immediately after the test equipment must work satisfactorily		P
	- required opening force not greater than the test force of 8.2.5.2 and table 8	11,4 N (required opening force) 150 N (test force acc. tab. 8)	P
	- equipment is able to carry its rated current after normal closing operation		P
8.3.6.3	Dielectric verification		P
	test voltage: $2 \cdot U_e$ with a minimum of 1000V~ .....	1000 V (tested with 1380 V)	—
	No flashover or breakdown		P
8.3.6.4	Leakage current		P
	test voltage (1,1 $U_e$ ) (V) .....	550 V (tested with 759 V)	—
	Leakage current (utilization categories AC-20A, AC-20B, DC-20A and DC-20B) $\leq 0,5$ mA/pole .....		N/A
	Leakage current (other utilization categories) $\leq 2,0$ mA/pole .....	0,001 mA	P
8.3.6.5	Temperature-rise verification		P
	Fuse-link details (fuse-combination units only):		—
	- manufacturer's name, trademark or identification mark .....	Bussmann	—
	- manufacturer's model or type reference .....	C10G25	—
	- rated current (A) .....	25 A (gG)	—
	- power loss (W) .....	2,6 W	—
	- rated breaking capacity (kA) .....	120 kA	—
	conductor cross-section (mm <sup>2</sup> ) .....	4 mm <sup>2</sup>	—
	- test current $I_e$ (A) .....	25 A	—
	Measured temperature-rise .....	see appended table 8.3.6.5 on page 112	P

TRF No. IEC60947\_3B



IEC 60947-3			
Clause	Requirement + Test	Result - Remark	Verdict
8.3.6	TEST SEQUENCE IV: CONDITIONAL SHORT-CIRCUIT CURRENT (Sample No. 20: 500 V, 25 A, 1-pole+N)		P
	Protective device details:		P
	- manufacturer's name, trademark or identification mark .....	Bussmann	—
	- manufacturer's model or type reference .....	C10G25	—
	- rated voltage (V) .....	500 V	—
	- rated current (A) .....	25 A (gG)	—
	- rated breaking capacity (kA) .....	120 kA	—
8.3.6.2	Fuse protected short-circuit withstand		P
	test voltage (1,05 Ue) (V) .....	L1: 537 V L2: — L3: —	—
	test current (kA) .....	L1: 107 kA L2: — L3: —	—
	rated frequency (Hz) .....	50 Hz	—
	power factor .....	0,2	—
	Time constant (ms) .....	—	—
	Fuse protected short-circuit withstand (equipment in closed position)		
	- max. let-through current (kA) .....	L1: 3,8 kA L2: — L3: —	—
	- Joule integral I <sup>2</sup> dt (A <sup>2</sup> s) .....	L1: 2000 A <sup>2</sup> s L2: — L3: —	—
	Fuse protected short-circuit making		P
	- mean velocity of 15 manually under no-load conditions operations (m/s) .....	1,6 m/s	—
	- point at which the measurement is made .....	point of rotation	—
	- test speed during the fuse protected short-circuit making (m/s) .....	1,5 m/s	—
	- max. let-through current (kA) .....	L1: 2,22 kA L2: — L3: —	—
	- Joule integral I <sup>2</sup> dt (A <sup>2</sup> s) .....	L1: 1000 A <sup>2</sup> s L2: — L3: —	—



IEC 60947-3			
Clause	Requirement + Test	Result - Remark	Verdict
8.3.6.2.5	Behaviour of the equipment during the test		P
	Test performed without:		—
	- endanger to the operator		P
	- cause damage to adjacent equipment		P
	No permanent arcing		P
	No flash over between poles and poles and frame		P
	No melting of the fuse in the detection circuit		P
8.3.6.2.6	Condition of the equipment after making and breaking capacity tests		P
	Immediately after the test equipment must work satisfactorily		P
	- required opening force not greater than the test force of 8.2.5.2 and table 8	20,6 N (required opening force) 150 N (test force acc. tab. 8)	P
	- equipment is able to carry its rated current after normal closing operation		P
8.3.6.3	Dielectric verification		P
	test voltage: $2 \cdot U_e$ with a minimum of 1000V~ .....	1000 V (tested with 1380 V)	—
	No flashover or breakdown		P
8.3.6.4	Leakage current		P
	test voltage (1,1 $U_e$ ) (V) .....	550 V (tested with 759 V)	—
	Leakage current (utilization categories AC-20A, AC-20B, DC-20A and DC-20B) $\leq 0,5$ mA/pole .....		N/A
	Leakage current (other utilization categories) $\leq 2,0$ mA/pole .....	0,001 mA	P
8.3.6.5	Temperature-rise verification		P
	Fuse-link details (fuse-combination units only):		—
	- manufacturer's name, trademark or identification mark .....	Bussmann	—
	- manufacturer's model or type reference .....	C10G25	—
	- rated current (A) .....	25 A (gG)	—
	- power loss (W) .....	2,6 W	—
	- rated breaking capacity (kA) .....	120 kA	—
	- conductor cross-section (mm <sup>2</sup> ) .....	4 mm <sup>2</sup>	—
	- test current $I_e$ (A) .....	25 A	—
	Measured temperature-rise .....	see appended table 8.3.6.5 on page 112	P

IEC 60947-3			
Clause	Requirement + Test	Result - Remark	Verdict
8.3.6	TEST SEQUENCE IV: CONDITIONAL SHORT-CIRCUIT CURRENT (Sample No. 21: 500 V, 25 A, 2-poles)		P
	Protective device details:		P
	- manufacturer's name, trademark or identification mark .....	Bussmann	—
	- manufacturer's model or type reference .....	C10G25	—
	- rated voltage (V) .....	500 V	—
	- rated current (A) .....	25 A (gG)	—
	- rated breaking capacity (kA) .....	120 kA	—
8.3.6.2	Fuse protected short-circuit withstand		P
	test voltage (1,05 Ue) (V) .....	L1: 537 V (310 V x $\sqrt{3}$ ) L2: 537 V (310 V x $\sqrt{3}$ ) L3: —	—
	test current (kA) .....	L1: 107 kA L2: 107 kA L3: —	—
	rated frequency (Hz) .....	50 Hz	—
	power factor .....	0,2	—
	Time constant (ms) .....	—	—
	Fuse protected short-circuit withstand (equipment in closed position)		
	- max. let-through current (kA) .....	L1: 3,71 kA L2: — L3: —	—
	- Joule integral I <sup>2</sup> dt (A <sup>2</sup> s) .....	L1: 1000 A <sup>2</sup> s L2: — L3: —	—
	Fuse protected short-circuit making		P
	- mean velocity of 15 manually under no-load conditions operations (m/s) .....	1,6 m/s	—
	- point at which the measurement is made .....	point of rotation	—
	- test speed during the fuse protected short-circuit making (m/s) .....	1,5 m/s	—
	- max. let-through current (kA) .....	L1: 3,64 kA L2: — L3: —	—
	- Joule integral I <sup>2</sup> dt (A <sup>2</sup> s) .....	L1: 1000 A <sup>2</sup> s L2: — L3: —	—

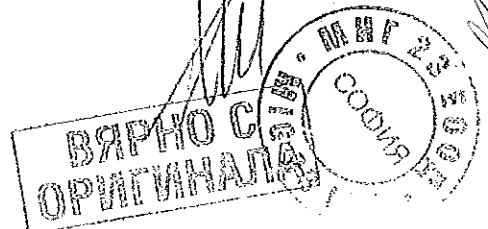

IEC 60947-3			
Clause	Requirement + Test	Result - Remark	Verdict
8.3.6.2.5	Behaviour of the equipment during the test		P
	Test performed without:		—
	- endanger to the operator		P
	- cause damage to adjacent equipment		P
	No permanent arcing		P
	No flash over between poles and poles and frame		P
	No melting of the fuse in the detection circuit		P
8.3.6.2.6	Condition of the equipment after making and breaking capacity tests		P
	Immediately after the test equipment must work satisfactorily		P
	- required opening force not greater than the test force of 8.2.5.2 and table 8	31,2 N (required opening force) 150 N (test force acc. tab. 8)	P
	- equipment is able to carry its rated current after normal closing operation		P
8.3.6.3	Dielectric verification		P
	test voltage: $2 \cdot U_e$ with a minimum of 1000V~ .....	1000 V (tested with 1380 V)	—
	No flashover or breakdown		P
8.3.6.4	Leakage current		P
	test voltage (1,1 $U_e$ ) (V) .....	550 V (tested with 759 V)	—
	Leakage current (utilization categories AC-20A, AC-20B, DC-20A and DC-20B) $\leq 0,5$ mA/pole .....		N/A
	Leakage current (other utilization categories) $\leq 2,0$ mA/pole .....	0,005 mA	P
8.3.6.5	Temperature-rise verification		P
	Fuse-link details (fuse-combination units only):		—
	- manufacturer's name, trademark or identification mark .....	Bussmann	—
	- manufacturer's model or type reference .....	C10G25	—
	- rated current (A) .....	25 A (gG)	—
	- power loss (W) .....	2,6 W	—
	- rated breaking capacity (kA) .....	120 kA	—
	- conductor cross-section (mm <sup>2</sup> ) .....	4 mm <sup>2</sup>	—
	- test current $I_e$ (A) .....	25 A	—
	Measured temperature-rise .....	see appended table 8.3.6.5 on page 112	—

TRF No. IEC60947\_3B

ВЯРНО С  
ОРИГИНАЛА

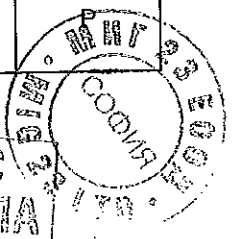

1056

IEC 60947-3			
Clause	Requirement + Test	Result - Remark	Verdict
8.3.6	TEST SEQUENCE IV: CONDITIONAL SHORT-CIRCUIT CURRENT (Sample No. 22: 500 V, 25 A, 3-poles+N)		P
	Protective device details:		P
	- manufacturer's name, trademark or identification mark .....	Bussmann	—
	- manufacturer's model or type reference .....	C10G25	—
	- rated voltage (V) .....	500 V	—
	- rated current (A) .....	25 A (gG)	—
	- rated breaking capacity (kA) .....	120 kA	—
8.3.6.2	Fuse protected short-circuit withstand		P
	test voltage (1,05 Ue) (V) .....	L1: 730 V (421,5 V x $\sqrt{3}$ ) L2: 730 V (421,5 V x $\sqrt{3}$ ) L3: 730 V (421,5 V x $\sqrt{3}$ )	—
	test current (kA) .....	L1: 102 kA L2: 102 kA L3: 101 kA	—
	rated frequency (Hz) .....	50 Hz	—
	power factor .....	0,2	—
	Time constant (ms) .....	—	—
	Fuse protected short-circuit withstand (equipment in closed position)		
	- max. let-through current (kA) .....	L1: 1,9 kA L2: 3,8 kA L3: 2,0 kA	—
	- Joule integral I <sup>2</sup> dt (A <sup>2</sup> s) .....	L1: 1000 A <sup>2</sup> s L2: 2000 A <sup>2</sup> s L3: 1000 A <sup>2</sup> s	—
	Fuse protected short-circuit making		P
	- mean velocity of 15 manually under no-load conditions operations (m/s) .....	1,6 m/s	—
	- point at which the measurement is made .....	point of rotation	—
	- test speed during the fuse protected short-circuit making (m/s) .....	1,4 m/s	—
	- max. let-through current (kA) .....	L1: 0 kA L2: 3,16 kA L3: 3,16 kA	—
	- Joule integral I <sup>2</sup> dt (A <sup>2</sup> s) .....	L1: 0 A <sup>2</sup> s L2: 1000 A <sup>2</sup> s L3: 1000 A <sup>2</sup> s	—

IEC 60947-3			
Clause	Requirement + Test	Result - Remark	Verdict
8.3.6.2.5	Behaviour of the equipment during the test		P
	Test performed without:		—
	- endanger to the operator		P
	- cause damage to adjacent equipment		P
	No permanent arcing		P
	No flash over between poles and poles and frame		P
	No melting of the fuse in the detection circuit		P
8.3.6.2.6	Condition of the equipment after making and breaking capacity tests		P
	Immediately after the test equipment must work satisfactorily		P
	- required opening force not greater than the test force of 8.2.5.2 and table 8	46,4 N (required opening force) 150 N (test force acc. tab. 8)	P
	- equipment is able to carry its rated current after normal closing operation		P
8.3.6.3	Dielectric verification		P
	test voltage: $2 \cdot U_e$ with a minimum of 1000V~ .....	1000 V (tested with 1380 V)	—
	No flashover or breakdown		P
8.3.6.4	Leakage current		P
	test voltage (1,1 $U_e$ ) (V) .....	550 V (tested with 759 V)	—
	Leakage current (utilization categories AC-20A, AC-20B, DC-20A and DC-20B) $\leq 0,5$ mA/pole .....		N/A
	Leakage current (other utilization categories) $\leq 2,0$ mA/pole .....	0,002 mA	P
8.3.6.5	Temperature-rise verification		P
	Fuse-link details (fuse-combination units only):		—
	- manufacturer's name, trademark or identification mark .....	Bussmann	—
	- manufacturer's model or type reference .....	C10G25	—
	- rated current (A) .....	25 A (gG)	—
	- power loss (W) .....	2,6 W	—
	- rated breaking capacity (kA) .....	120 kA	—
	- conductor cross-section (mm <sup>2</sup> ) .....	4 mm <sup>2</sup>	—
	- test current $I_e$ (A) .....	25 A	—
	Measured temperature-rise .....	see appended table 8.3.6.5 on page 113	P

IEC 60947-3			
Clause	Requirement + Test	Result - Remark	Verdict
8.3.6	TEST SEQUENCE IV: CONDITIONAL SHORT-CIRCUIT CURRENT (Sample No. 23: 690 V, 10 A, 1-pole)		P
	Protective device details:		P
	- manufacturer's name, trademark or identification mark .....	SIBA	—
	- manufacturer's model or type reference .....	50 179 06.10	—
	- rated voltage (V) .....	690 V	—
	- rated current (A) .....	10 A (gR)	—
	- rated breaking capacity (kA) .....	200 kA	—
8.3.6.2	Fuse protected short-circuit withstand		P
	test voltage (1,05 Ue) (V) .....	L1: 725 V L2: — L3: —	—
	test current (kA) .....	L1: 52,7 kA L2: — L3: —	—
	rated frequency (Hz) .....	50 Hz	—
	power factor .....	0,13	—
	Time constant (ms) .....	—	—
	Fuse protected short-circuit withstand (equipment in closed position)		
	- max. let-through current (kA) .....	L1: 2,0 kA L2: — L3: —	—
	- Joule integral I <sup>2</sup> dt (A <sup>2</sup> s) .....	L1: 0 A <sup>2</sup> s L2: — L3: —	—
	Fuse protected short-circuit making		P
	- mean velocity of 15 manually under no-load conditions operations (m/s) .....	1,6 m/s	—
	- point at which the measurement is made .....	point of rotation	—
	- test speed during the fuse protected short-circuit making (m/s) .....	1,5 m/s	—
	- max. let-through current (kA) .....	L1: 0,77 kA L2: — L3: —	—
	- Joule integral I <sup>2</sup> dt (A <sup>2</sup> s) .....	L1: 0 A <sup>2</sup> s L2: — L3: —	—

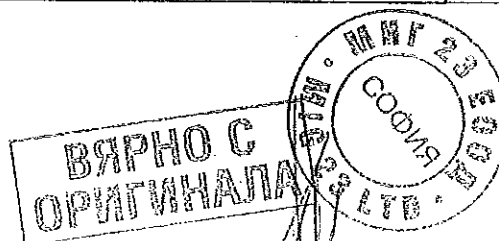



IEC 60947-3			
Clause	Requirement + Test	Result - Remark	Verdict
8.3.6.2.5	Behaviour of the equipment during the test		P
	Test performed without:		—
	- endanger to the operator		P
	- cause damage to adjacent equipment		P
	No permanent arcing		P
	No flash over between poles and poles and frame		P
	No melting of the fuse in the detection circuit		P
8.3.6.2.6	Condition of the equipment after making and breaking capacity tests		P
	Immediately after the test equipment must work satisfactorily		P
	- required opening force not greater than the test force of 8.2.5.2 and table 8	18,8 N (required opening force) 150 N (test force acc. tab. 8)	P
	- equipment is able to carry its rated current after normal closing operation		P
8.3.6.3	Dielectric verification		P
	test voltage: $2 \cdot U_e$ with a minimum of 1000V~ .....	1380 V	—
	No flashover or breakdown		P
8.3.6.4	Leakage current		P
	test voltage (1,1 $U_e$ ) (V) .....	759 V	—
	Leakage current (utilization categories AC-20A, AC-20B, DC-20A and DC-20B) $\leq 0,5$ mA/pole .....		N/A
	Leakage current (other utilization categories) $\leq 2,0$ mA/pole .....	0,002 mA	P
8.3.6.5	Temperature-rise verification		P
	Fuse-link details (fuse-combination units only):		—
	- manufacturer's name, trademark or identification mark .....	SIBA	—
	- manufacturer's model or type reference .....	50 179 06.10	—
	- rated current (A) .....	10 A (gR)	—
	- power loss (W) .....	2,3 W	—
	- rated breaking capacity (kA) .....	200 kA	—
	- conductor cross-section (mm <sup>2</sup> ) .....	1,5 mm <sup>2</sup>	—
	- test current $I_e$ (A) .....	10 A	—
	Measured temperature-rise .....	see appended table 8.3.6.5 on page 113	P

TRF No. IEC60947\_3B

ВЯРНО-С  
ОРИГИНАЛ

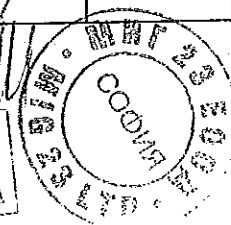

1061

IEC 60947-3			
Clause	Requirement + Test	Result - Remark	Verdict
8.3.6	TEST SEQUENCE IV: CONDITIONAL SHORT-CIRCUIT CURRENT (Sample No. 24: 690 V, 10 A, 1-pole+N)		P
	Protective device details:		P
	- manufacturer's name, trademark or identification mark .....	SIBA	—
	- manufacturer's model or type reference .....	50 179 06.10	—
	- rated voltage (V) .....	690 V	—
	- rated current (A) .....	10 A (gR)	—
	- rated breaking capacity (kA) .....	200 kA	—
8.3.6.2	Fuse protected short-circuit withstand		P
	test voltage (1,05 Ue) (V) .....	L1: 726 V L2: — L3: —	—
	test current (kA) .....	L1: 52,7 kA L2: — L3: —	—
	rated frequency (Hz) .....	50 Hz	—
	power factor .....	0,13	—
	Time constant (ms) .....	—	—
	Fuse protected short-circuit withstand (equipment in closed position)		
	- max. let-through current (kA) .....	L1: 1,02 kA L2: — L3: —	—
	- Joule integral I <sup>2</sup> dt (A <sup>2</sup> s) .....	L1: 0 A <sup>2</sup> s L2: — L3: —	—
	Fuse protected short-circuit making		P
	- mean velocity of 15 manually under no-load conditions operations (m/s) .....	1,6 m/s	—
	- point at which the measurement is made .....	point of rotation	—
	- test speed during the fuse protected short-circuit making (m/s) .....	1,5 m/s	—
	- max. let-through current (kA) .....	L1: 0,78 kA L2: — L3: —	—
	- Joule integral I <sup>2</sup> dt (A <sup>2</sup> s) .....	L1: 0 A <sup>2</sup> s L2: — L3: —	—

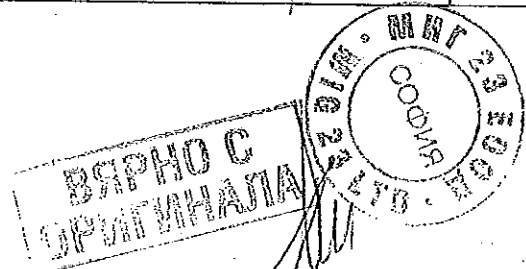

Handwritten signature and scribbles.

IEC 60947-3			
Clause	Requirement + Test	Result - Remark	Verdict
8.3.6.2.5	Behaviour of the equipment during the test		P
	Test performed without:		—
	- endanger to the operator		P
	- cause damage to adjacent equipment		P
	No permanent arcing		P
	No flash over between poles and poles and frame		P
	No melting of the fuse in the detection circuit		P
8.3.6.2.6	Condition of the equipment after making and breaking capacity tests		P
	Immediately after the test equipment must work satisfactorily		P
	- required opening force not greater than the test force of 8.2.5.2 and table 8	25,4 N (required opening force) 150 N (test force acc. tab. 8)	P
	- equipment is able to carry its rated current after normal closing operation		P
8.3.6.3	Dielectric verification		P
	test voltage: $2 \cdot U_e$ with a minimum of 1000V~ .....	1380 V	—
	No flashover or breakdown		P
8.3.6.4	Leakage current		P
	test voltage (1,1 $U_e$ ) (V) .....	759 V	—
	Leakage current (utilization categories AC-20A, AC-20B, DC-20A and DC-20B) $\leq 0,5$ mA/pole .....		N/A
	Leakage current (other utilization categories) $\leq 2,0$ mA/pole .....	0,001 mA	P
8.3.6.5	Temperature-rise verification		P
	Fuse-link details (fuse-combination units only):		—
	- manufacturer's name, trademark or identification mark .....	SIBA	—
	- manufacturer's model or type reference .....	50 179 06.10	—
	- rated current (A) .....	10 A (gR)	—
	- power loss (W) .....	2,3 W	—
	- rated breaking capacity (kA) .....	200 kA	—
	- conductor cross-section (mm <sup>2</sup> ) .....	1,5 mm <sup>2</sup>	—
	- test current $I_e$ (A) .....	10 A	—
	Measured temperature-rise .....	see appended table 8.3.6.5 on page 113	P

ВРНО  
 ОПИТУВАЊЕ

IEC 60947-3			
Clause	Requirement + Test	Result - Remark	Verdict
8.3.6	TEST SEQUENCE IV: CONDITIONAL SHORT-CIRCUIT CURRENT (Sample No. 25: 690 V, 10 A, 2-poles)		P
	Protective device details:		P
	- manufacturer's name, trademark or identification mark .....	SIBA	—
	- manufacturer's model or type reference .....	50 179 06.10	—
	- rated voltage (V) .....	690 V	—
	- rated current (A) .....	10 A (gR)	—
	- rated breaking capacity (kA) .....	200 kA	—
8.3.6.2	Fuse protected short-circuit withstand		P
	test voltage (1,05 Ue) (V) .....	L1: 726 V (419,16 V x √3) L2: 726 V (419,16 V x √3) L3: —	—
	test current (kA) .....	L1: 52,7 kA L2: 52,7 kA L3: —	—
	rated frequency (Hz) .....	50 Hz	—
	power factor .....	0,13	—
	Time constant (ms) .....	—	—
	Fuse protected short-circuit withstand (equipment in closed position)		
	- max. let-through current (kA) .....	L1: 0,61 kA L2: — L3: —	—
	- Joule integral I <sup>2</sup> dt (A <sup>2</sup> s) .....	L1: 0 A <sup>2</sup> s L2: — L3: —	—
	Fuse protected short-circuit making		P
	- mean velocity of 15 manually under no-load conditions operations (m/s) .....	1,6 m/s	—
	- point at which the measurement is made .....	point of rotation	—
	- test speed during the fuse protected short-circuit making (m/s) .....	1,5 m/s	—
	- max. let-through current (kA) .....	L1: 0,55 kA L2: — L3: —	—
	- Joule integral I <sup>2</sup> dt (A <sup>2</sup> s) .....	L1: 0 A <sup>2</sup> s L2: — L3: —	—



IEC 60947-3			
Clause	Requirement + Test	Result - Remark	Verdict
8.3.6.2.5	Behaviour of the equipment during the test		P
	Test performed without:		—
	- endanger to the operator		P
	- cause damage to adjacent equipment		P
	No permanent arcing		P
	No flash over between poles and poles and frame		P
	No melting of the fuse in the detection circuit		P
8.3.6.2.6	Condition of the equipment after making and breaking capacity tests		P
	Immediately after the test equipment must work satisfactorily		P
	- required opening force not greater than the test force of 8.2.5.2 and table 8	34,2 N (required opening force) 150 N (test force acc. tab. 8)	P
	- equipment is able to carry its rated current after normal closing operation		P
8.3.6.3	Dielectric verification		P
	test voltage: 2*Ue with a minimum of 1000V~ .....	1380 V	—
	No flashover or breakdown		P
8.3.6.4	Leakage current		P
	test voltage (1,1 Ue) (V) .....	759 V	—
	Leakage current (utilization categories AC-20A, AC-20B, DC-20A and DC-20B) ≤ 0,5 mA/pole .....		N/A
	Leakage current (other utilization categories) ≤ 2,0 mA/pole .....	0,003 mA	P
8.3.6.5	Temperature-rise verification		P
	Fuse-link details (fuse-combination units only):		—
	- manufacturer's name, trademark or identification mark .....	SIBA	—
	- manufacturer's model or type reference .....	50 179 06.10	—
	- rated current (A) .....	10 A (gR)	—
	- power loss (W) .....	2,3 W	—
	- rated breaking capacity (kA) .....	200 kA	—
	- conductor cross-section (mm <sup>2</sup> ) .....	1,5 mm <sup>2</sup>	—
	- test current Ie (A) .....	10 A	—
	Measured temperature-rise .....	see appended table 8.3.6.5 on page 114	P

ВЯРНО С  
ОРИГИНАЛА

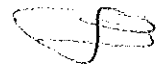

IEC 60947-3			
Clause	Requirement + Test	Result - Remark	Verdict
8.3.6	TEST SEQUENCE IV: CONDITIONAL SHORT-CIRCUIT CURRENT (Sample No. 26: 690 V, 32 A, 3-poles+N)		P
	Protective device details:		P
	- manufacturer's name, trademark or identification mark .....	Bussmann	—
	- manufacturer's model or type reference .....	C10G32	—
	- rated voltage (V) .....	400 V	—
	- rated current (A) .....	32 A (gG)	—
	- rated breaking capacity (kA) .....	120 kA	—
8.3.6.2	Fuse protected short-circuit withstand		P
	test voltage (1,05 Ue) (V) .....	L1: 726 V (419,16 V x √3) L2: 726 V (419,16 V x √3) L3: 726 V (419,16 V x √3)	—
	test current (kA) .....	L1: 50,9 kA L2: 52,2 kA L3: 51,0 kA	—
	rated frequency (Hz) .....	50 Hz	—
	power factor .....	0,23	—
	Time constant (ms) .....	—	—
	Fuse protected short-circuit withstand (equipment in closed position)		
	- max. let-through current (kA) .....	L1: 0,9 kA L2: 5,6 kA L3: 5,6 kA	—
	- Joule integral I <sup>2</sup> dt (A <sup>2</sup> s) .....	L1: 2000 A <sup>2</sup> s L2: 8000 A <sup>2</sup> s L3: 6000 A <sup>2</sup> s	—
	Fuse protected short-circuit making		P
	- mean velocity of 15 manually under no-load conditions operations (m/s) .....	1,6 m/s	—
	- point at which the measurement is made .....	point of rotation	—
	- test speed during the fuse protected short-circuit making (m/s) .....	1,4 m/s	—
	- max. let-through current (kA) .....	L1: 5,3 kA L2: 5,3 kA L3: 0 kA	—
	- Joule integral I <sup>2</sup> dt (A <sup>2</sup> s) .....	L1: 5000 A <sup>2</sup> s L2: 5000 A <sup>2</sup> s L3: 0 A <sup>2</sup> s	—



IEC 60947-3			
Clause	Requirement + Test	Result - Remark	Verdict
8.3.6.2.5	Behaviour of the equipment during the test		P
	Test performed without:		—
	- endanger to the operator		P
	- cause damage to adjacent equipment		P
	No permanent arcing		P
	No flash over between poles and poles and frame		P
	No melting of the fuse in the detection circuit		P
8.3.6.2.6	Condition of the equipment after making and breaking capacity tests		P
	Immediately after the test equipment must work satisfactorily		P
	- required opening force not greater than the test force of 8.2.5.2 and table 8	51,6 N (required opening force) 150 N (test force acc. tab. 8)	P
	- equipment is able to carry its rated current after normal closing operation		P
8.3.6.3	Dielectric verification		P
	test voltage: 2*Ue with a minimum of 1000V~ .....	1380 V	—
	No flashover or breakdown		P
8.3.6.4	Leakage current		P
	test voltage (1,1 Ue) (V) .....	759 V	—
	Leakage current (utilization categories AC-20A, AC-20B, DC-20A and DC-20B) ≤ 0,5 mA/pole .....		N/A
	Leakage current (other utilization categories) ≤ 2,0 mA/pole .....	0,002 mA	P
8.3.6.5	Temperature-rise verification		P
	Fuse-link details (fuse-combination units only):		—
	- manufacturer's name, trademark or identification mark .....	Bussmann	—
	- manufacturer's model or type reference .....	C10G32	—
	- rated current (A) .....	32 A (gG)	—
	- power loss (W) .....	2,9 W	—
	- rated breaking capacity (kA) .....	120 kA	—
	- conductor cross-section (mm²) .....	6 mm²	—
	- test current Ie (A) .....	32 A	—
	Measured temperature-rise .....	see appended table 8.3.6.5 on page 114	P

Handwritten signatures and stamps, including a circular stamp with text: "VDE 249800-4402-0705/152633" and "COO 23 11/12".

IEC 60947-3			
Clause	Requirement + Test	Result - Remark	Verdict
8.3.7	TEST SEQUENCE V: OVERLOAD PERFORMANCE CAPABILITY (Sample No. 27: 690 V, 32 A, 1-pole)		P
8.3.7.1	Overload test		P
	ambient temperature 10-40 °C .....	25,6 °C	—
	test enclosure W x H x D (mm x mm x mm) .....	—	—
	material of enclosure .....	—	—
	test current 1,6xI <sub>th</sub> or 1,6xI <sub>th</sub> (A) .....	52	—
	cable/busbar cross-section (mm <sup>2</sup> ) / length (mm) ....	6 mm <sup>2</sup> cable / 1000 mm long	—
	Fuse-link details:		P
	- manufacturer's name, trademark or identification mark .....	Bussmann	—
	- rated current (A) .....	32 A (gG)	—
	- power loss (W) .....	2,9 W	—
	- rated breaking capacity (kA) .....	120 kA	—
	- time duration of the overload test (s) .....	824 s	—
	Within 3 to 5 min after the fuse(s) has(have) operated (or 1 h), the equipment has been operated once, i.e. opened and closed		P
	Required opening force not greater than the test force of 8.2.5.2 and table 8	14 N (required opening force) 150 N (test force acc. tab. 8)	P
	The equipment has not undergone any impairment hindering such operation		P
8.3.7.2	Dielectric verification		P
	test voltage: 2*U <sub>e</sub> with a minimum of 1000V~ .....	1380 V	—
	No flashover or breakdown		P
8.3.7.3	Leakage current		P
	test voltage (1,1 U <sub>e</sub> ) (V) .....	759 V	—
	Leakage current (utilization categories AC-20A, AC-20B, DC-20A and DC-20B) ≤ 0,5 mA/pole .....		N/A
	Leakage current (other utilization categories) ≤ 2 mA/pole .....	0,002 mA	P





IEC 60947-3			
Clause	Requirement + Test	Result - Remark	Verdict
8.3.7.4	Temperature-rise verification		P
	Fuse-link details (fuse-combination units only):		—
	- manufacturer's name, trademark or identification mark .....	Bussmann	—
	- manufacturer's model or type reference .....	C10G32	—
	- rated current (A) .....	32 A (gG)	—
	- power loss (W) .....	2,9 W	—
	- rated breaking capacity (kA) .....	120 kA	—
	Fuse links aged during the overload test are replaced by new fuse-links .....		P
	- conductor cross-section (mm <sup>2</sup> ) .....	6 mm <sup>2</sup>	—
	- test current I <sub>e</sub> (A) .....	32 A	—
	Measured temperature-rise .....	see appended table 8.3.7.4 on page 114	P



IEC 60947-3			
Clause	Requirement + Test	Result - Remark	Verdict
8.3.7	TEST SEQUENCE V: OVERLOAD PERFORMANCE CAPABILITY (Sample No. 28: 690 V, 32 A, 2-poles)		P
8.3.7.1	Overload test		P
	ambient temperature 10-40 °C .....	23,6 °C	—
	test enclosure W x H x D (mm x mm x mm) .....	—	—
	material of enclosure .....	—	—
	test current 1,6xI <sub>th</sub> e or 1,6xI <sub>th</sub> (A) .....	52	—
	cable/busbar cross-section (mm <sup>2</sup> ) / length (mm) ...	6 mm <sup>2</sup> cable / 1000 mm long	—
	Fuse-link details:		P
	- manufacturer's name, trademark or identification mark .....	Bussmann	—
	- rated current (A) .....	32 A (gG)	—
	- power loss (W) .....	2,9 W	—
	- rated breaking capacity (kA) .....	120 kA	—
	- time duration of the overload test (s) .....	573 s	—
	Within 3 to 5 min after the fuse(s) has(have) operated (or 1 h), the equipment has been operated once, i.e. opened and closed		P
	Required opening force not greater than the test force of 8.2.5.2 and table 8	17,2 N (required opening force) 150 N (test force acc. tab. 8)	P
	The equipment has not undergone any impairment hindering such operation		P
8.3.7.2	Dielectric verification		P
	test voltage: 2*U <sub>e</sub> with a minimum of 1000V~ .....	1380 V	—
	No flashover or breakdown		P
8.3.7.3	Leakage current		P
	test voltage (1,1 U <sub>e</sub> ) (V) .....	759 V	—
	Leakage current (utilization categories AC-20A, AC-20B, DC-20A and DC-20B) ≤ 0,5 mA/pole .....		N/A
	Leakage current (other utilization categories) ≤ 2 mA/pole .....	0,001 mA	P



IEC 60947-3			
Clause	Requirement + Test	Result - Remark	Verdict
8.3.7.4	Temperature-rise verification		P
	Fuse-link details (fuse-combination units only):		—
	- manufacturer's name, trademark or identification mark .....	Bussmann	—
	- manufacturer's model or type reference .....	C10G32	—
	- rated current (A) .....	32 A (gG)	—
	- power loss (W) .....	2,9 W	—
	- rated breaking capacity (kA) .....	120 kA	—
	Fuse links aged during the overload test are replaced by new fuse-links .....		P
	- conductor cross-section (mm <sup>2</sup> ) .....	6 mm <sup>2</sup>	—
	- test current I <sub>e</sub> (A) .....	32 A	—
	Measured temperature-rise .....	see appended table 8.3.7.4 on page 115	P

ВЕРНО  
ОРИГИНАЛ

108.

IEC 60947-3			
Clause	Requirement + Test	Result - Remark	Verdict
8.3.7	TEST SEQUENCE V: OVERLOAD PERFORMANCE CAPABILITY (Sample No. 29: 690 V, 32 A, 3-poles+N)		P
8.3.7.1	Overload test		P
	ambient temperature 10-40 °C .....	23,6 °C	—
	test enclosure W x H x D (mm x mm x mm) .....	—	—
	material of enclosure .....	—	—
	test current 1,6xI <sub>th</sub> e or 1,6xI <sub>th</sub> (A) .....	52	—
	cable/busbar cross-section (mm <sup>2</sup> ) / length (mm) ...:	6 mm <sup>2</sup> cable / 1000 mm long	—
	Fuse-link details:		P
	- manufacturer's name, trademark or identification mark .....	Bussmann	—
	- rated current (A) .....	32 A (gG)	—
	- power loss (W) .....	2,9 W	—
	- rated breaking capacity (kA) .....	120 kA	—
	- time duration of the overload test (s) .....	540 s	—
	Within 3 to 5 min after the fuse(s) has(have) operated (or 1 h), the equipment has been operated once, i.e. opened and closed		P
	Required opening force not greater than the test force of 8.2.5.2 and table 8	35,2 N (required opening force) 150 N (test force acc. tab. 8)	P
	The equipment has not undergone any impairment hindering such operation		P
8.3.7.2	Dielectric verification		P
	test voltage: 2*U <sub>e</sub> with a minimum of 1000V~ .....	1380 V	—
	No flashover or breakdown		P
8.3.7.3	Leakage current		P
	test voltage (1,1 U <sub>e</sub> ) (V) .....	759 V	—
	Leakage current (utilization categories AC-20A, AC-20B, DC-20A and DC-20B) ≤ 0,5 mA/pole .....		N/A
	Leakage current (other utilization categories) ≤ 2 mA/pole .....	0,001 mA	P

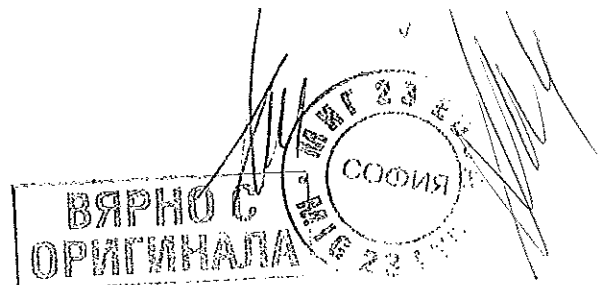

IEC 60947-3			
Clause	Requirement + Test	Result - Remark	Verdict
8.3.7.4	Temperature-rise verification		P
	Fuse-link details (fuse-combination units only):		—
	- manufacturer's name, trademark or identification mark .....	Bussmann	—
	- manufacturer's model or type reference .....	C10G32	—
	- rated current (A) .....	32 A (gG)	—
	- power loss (W) .....	2,9 W	—
	- rated breaking capacity (kA) .....	120 kA	—
	Fuse links aged during the overload test are replaced by new fuse-links .....		P
	- conductor cross-section (mm <sup>2</sup> ) .....	6 mm <sup>2</sup>	—
	- test current I <sub>e</sub> (A) .....	32 A	—
	Measured temperature-rise .....	see appended table 8.3.7.4 on page 115	P

8.4	ELECTROMAGNETIC COMPATIBILITY TESTS		N/A
8.4.1	Immunity		N/A
8.4.1.1	Equipment not incorporating electronic circuits: no tests necessary		N/A
8.4.1.2	Equipment incorporating electronic circuits:		N/A
	Equipment utilizing circuits in which all components are passive are not required to be tested		N/A
	All other equipment, requirements according to 7.3.3.2 and limits according table 6 apply		N/A
	Performed tests.....	see _____	N/A
	No unintentional separation or closing of contacts has occurred during these tests .....		N/A
8.4.2	Emission		N/A
8.4.2.1	Equipment not incorporating electronic circuits: no tests necessary		N/A
8.4.2.2	Equipment incorporating electronic circuits:		N/A
	Equipment utilizing circuits in which all components are passive are not required to be tested		N/A
	All other equipment, requirements according to 7.3.3.2 and limits according table 7 apply		N/A
	Performed tests.....	see _____	N/A

IEC 60947-3			
Clause	Requirement + Test	Result - Remark	Verdict
<b>Annex A (normative)</b>			N/A
A	Equipment for direct switching of a single motor		N/A
A.1	Additional rated duties.....:		N/A
A.1.1	- intermittent periodic duty		N/A
	- intermittent duty		N/A
A.1.1.1	Classes of intermittent duty .....		N/A
	-class 1: up to 1 operating cycle per hour		N/A
	-class 3: up to 3 operating cycle per hour		N/A
	-class 12: up to 12 operating cycles per hour		N/A
	-class 30: up to 30 operating cycles per hour		N/A
	-class 120: up to 120 operating cycles per hour		N/A
A.1.2	Temporary duty.....:		N/A
A.5	Mechanical durability:		N/A
	Equipment mounted according to manufacturer's instruction		N/A
	Preferred number of no-load operating cycles expressed in millions.....:		N/A
	0,001 – 0,003 – 0,01 – 0,03 – 0,1 – 0,3 - 1		N/A
	If no mechanical endurance is stated by the manufacturer, a minimum mechanical endurance according to the class of intermittent duty shall be tested.	Class of intermittent duty:	N/A
	Number of no-load operating cycles performed.....:		N/A
A.6	Electrical durability:		N/A
	- test according to manufacturer's instruction		N/A
A.7	Verification of making and breaking capacities:		N/A
	- utilization category .....		—
	- rated operational voltage $U_e$ (V) .....		—
	- rated operational current $I_e$ (A) or power (kW) .....		—
	Conditions for make/break operations or make operations:		—
	- test voltage, $U = 1,05 U_e$ ..... (V):	L1: L2: L3:	—
	- test current, $I =$ ..... x $I_e$ (A):	L1: L2: L3:	—

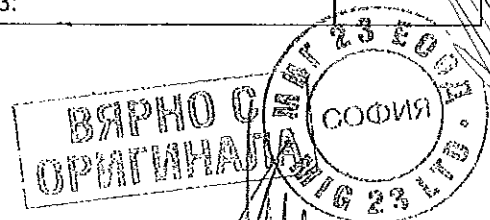

IEC 60947-3			
Clause	Requirement + Test	Result - Remark	Verdict
	- power factor .....	L1: L2: L3:	—
	Conditions for make/break operations:		N/A
	- test voltage, $U = 1,05 U_e$ ..... (V):	L1: L2: L3:	—
	- test current, $I =$ ..... x $I_e$ (A):	L1: L2: L3:	—
	- power factor/ time constant .....	L1: L2: L3:	—
	Number of make/break or make and break operations .....		N/A
	- recovery voltage duration ( $\geq 50$ ms)		N/A
	- current duration (ms) .....		—
	- time interval between operations .....		N/A
	Characteristic of transient recovery voltage if necessary:		N/A
	- oscillatory frequency (kHz) .....		—
	- measured oscillatory frequency (kHz) .....	L1: L2: L3:	N/A
	- factor $\gamma$ .....	L1: L2: L3:	N/A
8.3.3.3.5	Behaviour of the equipment during making and breaking capacity tests		N/A
	Test performed without:		—
	- endanger to the operator		N/A
	- cause damage to adjacent equipment		N/A
	No permanent arcing		N/A
	No flash over between poles and poles and frame		N/A
	No melting of the fuse in the detection circuit		N/A

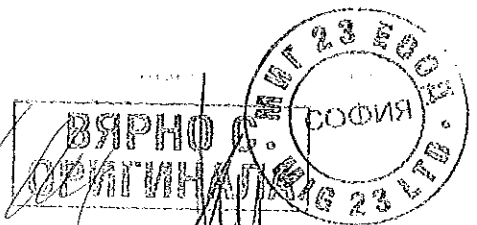

IEC 60947-3			
Clause	Requirement + Test	Result - Remark	Verdict
8.3.3.3.6	Condition of the equipment after making and breaking capacity tests		N/A
	Immediately after the test equipment must work satisfactorily		N/A
	- required opening force not greater than the test force of 8.2.5.2 and table 8		N/A
	- equipment is able to carry its rated current after normal closing operation		N/A
8.3.3.4	Dielectric verification		N/A
	test voltage: $2 \cdot U_e$ with a minimum of 1000V~ .....		—
	No flashover or breakdown		N/A
8.3.3.5	Leakage current		N/A
	test voltage (1,1 $U_e$ ) (V) .....		—
	Leakage current (utilization categories AC-20A, AC-20B, DC-20A and DC-20B): $\leq 0,5$ mA/pole .....		N/A
	Leakage current (other utilization categories): $\leq 2$ mA/pole) .....		N/A
8.3.3.6	Temperature-rise verification		N/A
	- conductor cross-section (mm <sup>2</sup> ) .....		—
	- test current $I_e$ (A) .....		—
	Measured temperature-rise .....	see ___	N/A
A.8	Operational performance test:		N/A
	- utilization category .....		—
	- rated operational voltage (V) .....		—
	- rated operational current (A) .....		—
	Test conditions for electrical operation cycles:		N/A
	- test voltage (V) .....	L1: L2: L3:	—
	- test current (A) .....	L1: L2: L3:	—
	- power factor/time constant .....	L1: L2: L3:	—
	Number of cycles with current .....		N/A
	Number of cycles without current .....		N/A





IEC 60947-3			
Clause	Requirement + Test	Result - Remark	Verdict
	First test sequence (with/without current) .....		—
	Second test sequence (with/without current) .....		—
	- time interval between first and second test sequence .....		—
8.3.4.1.5	Behaviour of the equipment during the operational performance test		N/A
	Test performed without:		—
	- endanger to the operator		N/A
	- cause damage to adjacent equipment		N/A
	No permanent arcing		N/A
	No flash over between poles and poles and frame		N/A
	No melting of the fuse in the detection circuit		N/A
8.3.4.1.6	Condition of the equipment after making and breaking capacity tests		N/A
	Immediately after the test equipment must work satisfactorily		N/A
	- required opening force not greater than the test force of 8.2.5.2 and table 8		N/A
	- equipment is able to carry its rated current after normal closing operation		N/A
8.3.4.2	Dielectric verification		N/A
	test voltage: $2 \cdot U_e$ with a minimum of 1000V~ .....		—
	No breakdown or flashover		N/A
8.3.4.3	Leakage current		N/A
	test voltage (1,1 $U_e$ ) (V) .....		—
	Leakage current (utilization categories AC-20A, AC-20B, DC-20A and DC-20B) $\leq 0,5$ mA/pole .....		N/A
	Leakage current (other utilization categories) $\leq 2$ mA/pole .....		N/A
8.3.4.4	Temperature-rise verification		N/A
	- conductor cross-section (mm <sup>2</sup> ) .....		—
	- test current $I_e$ (A) .....		—
	Measured temperature-rise .....	see ___	N/A
A.9	Special tests:	see ___	N/A

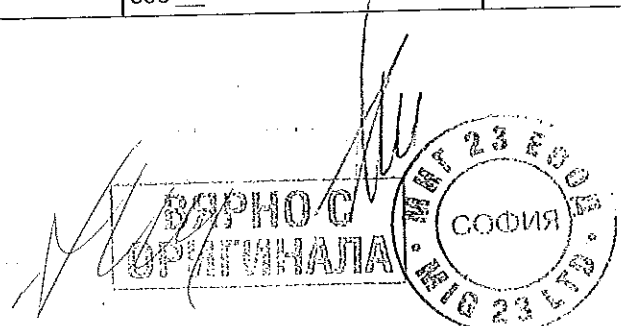

IEC 60947-3			
Clause	Requirement + Test	Result - Remark	Verdict
Annex C (normative)			N/A
C	Single pole operated three pole switches		N/A
C.1	Three pole operated switches of fundamentally the same design, already successfully tested are deemed to satisfy the requirements of individually operated three pole devices.		N/A
C.2	Additional-tests to be performed on single pole operated three pole switches		N/A
	Test "8.3.3.3 Making and breaking capacities" according to test sequence I with following modifications		N/A
	L1 and L2 are closed, L3 is subjected to the required make-break operation cycle .....		N/A
	L2 closed and L3 opened, L1 is subjected to the required make-break operation cycle .....		N/A
	Test performed in a three phase circuit		N/A
	Test "8.3.4.1 Operational performance" according to test sequence II with following modifications		N/A
	L1 and L2 are closed, L3 is subjected to the required make-break operation cycle .....		N/A
	L2 closed and L3 opened, L1 is subjected to the required make-break operation cycle .....		N/A
	Test performed in a three phase circuit		N/A
	Test "8.3.6.2 Fuse protected short circuit test" according to test sequence IV with following modifications		N/A
	For the making test L1 shall be open and L2 closed, L3 is subjected to the required make operation cycle .....		N/A
	L2 closed and L3 opened, L1 is subjected to the required make-break operation cycle .....		N/A
	Test performed in a three phase circuit		N/A
C.5	Instruction for use		N/A
	The product literature includes following statement :		N/A
	These devices are intended for power distribution systems where switching and/or isolating of an individual phase may be necessary and shall not be used for the switching of the primary circuit of three-phase equipment.		N/A



IEC 60947-3			
Clause	Requirement + Test	Result - Remark	Verdict

7.1.4	TABLE: Clearance and creepage distance measurements						
clearance cl and creepage distance dcr at/of:	Up (V)	U r.m.s. (V)	required cl (mm)	cl (mm)	required dcr (mm)	dcr (mm)	
Between active parts and parts intended to be touched	7300	800	2	>5,5	11	>11	
Between active parts and enclosure	7300	800	2	>5,5	11	>11	
Between active parts and fuse-link with the contacts in open position	9800	800	2	>5,5	11	>11	
supplementary information:							

8.3.3.1	TABLE: Temperature-rise (measurements) (Sample No. 1: I <sub>e</sub> = 25 A)		P
Temperature rise dT of part:	dT (K) measured	dT (K) required	
Above terminals (cable connection)	39,3	70	
Below terminals (cable connection)	35,3	70	
Manual operating means: metallic / non-metallic	4,3	25	
Parts intended to be touched but not hand-held: metallic / non-metallic	8,5	40	
Parts which need not be touched during normal operation: metallic / non-metallic	12,8	50	
supplementary information:		Ambient temperature:	22,7 °C

8.3.3.6	TABLE: Temperature-rise (measurements) (Sample No. 1: I <sub>e</sub> = 25 A)		P
Temperature rise dT of part:	dT (K) measured	dT (K) required	
Terminals	37,2	80	
Manual operating means: metallic / non-metallic	4,6	35	
Parts intended to be touched but not hand-held: metallic / non-metallic	6,1	50	
Parts which need not be touched during normal operation: metallic / non-metallic	17,0	60	
supplementary information:		Ambient temperature:	22,9 °C

TRF No. IEC60947\_3B

ВЕРНО С  
ОРИГИНАЛА

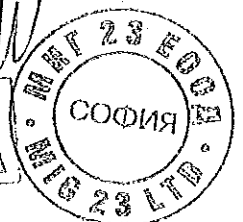

108

IEC 60947-3			
Clause	Requirement + Test	Result - Remark	Verdict
8.3.3.1	<b>TABLE: Temperature-rise (measurements)</b> (Sample No. 2: $I_b = 10$ A)		P
Temperature rise dT of part:		dT (K) measured	dT (K) required
Above terminals (cable connection)		31,7	70
Below terminals (cable connection)		29,8	70
Manual operating means: metallic / non-metallic		5,0	25
Parts intended to be touched but not hand-held: metallic / non-metallic		8,8	40
Parts which need not be touched during normal operation: metallic / non-metallic		15,3	50
<b>supplementary information:</b>		Ambient temperature:	22,7 °C

8.3.3.6	<b>TABLE: Temperature-rise (measurements)</b> (Sample No. 2: $I_b = 10$ A)		P
Temperature rise dT of part:		dT (K) measured	dT (K) required
Terminals		32,9	80
Manual operating means: metallic / non-metallic		3,7	35
Parts intended to be touched but not hand-held: metallic / non-metallic		5,4	50
Parts which need not be touched during normal operation: metallic / non-metallic		19,4	60
<b>supplementary information:</b>		Ambient temperature:	23,8 °C

8.3.3.1	<b>TABLE: Temperature-rise (measurements)</b> (Sample No. 3: $I_b = 32$ A)		P
Temperature rise dT of part:		dT (K) measured	dT (K) required
Above terminals (cable connection)		45,0	70
Below terminals (cable connection)		37,5	70
Manual operating means: metallic / non-metallic		5,5	25
Parts intended to be touched but not hand-held: metallic / non-metallic		13,8	40
Parts which need not be touched during normal operation: metallic / non-metallic		12,0	50
<b>supplementary information:</b>		Ambient temperature:	22,7 °C

IEC 60947-3			
Clause	Requirement + Test	Result - Remark	Verdict

8.3.3.6	TABLE: Temperature-rise (measurements) (Sample No. 3: $I_e = 32$ A)	P	
Temperature rise dT of part:		dT (K) measured	dT (K) required
Terminals		39,0	80
Manual operating means: <del>metallie</del> / non-metallic		4,8	35
Parts intended to be touched but not hand-held: <del>metallie</del> / non-metallic		5,4	50
Parts which need not be touched during normal operation: <del>metallie</del> / non-metallic		21,1	60
<b>supplementary information:</b>		Ambient temperature: 24,3 °C	

8.3.3.1	TABLE: Temperature-rise (measurements) (Sample No. 4: $I_e = 32$ A)	P	
Temperature rise dT of part:		dT (K) measured	dT (K) required
Above terminals (cable connection)		48,5	70
Below terminals (cable connection)		47,3	70
Manual operating means: <del>metallie</del> / non-metallic		7,8	25
Parts intended to be touched but not hand-held: <del>metallie</del> / non-metallic		21,8	40
Parts which need not be touched during normal operation: <del>metallie</del> / non-metallic		14,5	50
<b>supplementary information:</b>		Ambient temperature: 22,7 °C	

8.3.3.6	TABLE: Temperature-rise (measurements) (Sample No. 4: $I_e = 32$ A)	P	
Temperature rise dT of part:		dT (K) measured	dT (K) required
Terminals		49,0	80
Manual operating means: <del>metallie</del> / non-metallic		8,8	35
Parts intended to be touched but not hand-held: <del>metallie</del> / non-metallic		12,9	50
Parts which need not be touched during normal operation: <del>metallie</del> / non-metallic		26,9	60
<b>supplementary information:</b>		Ambient temperature: 24,4 °C	

TRF No. IEC60947\_3B

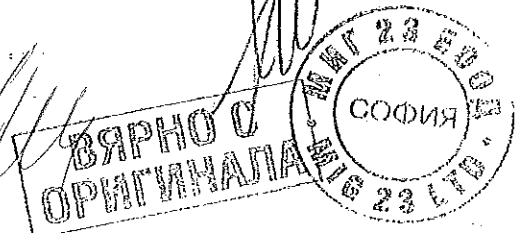

08

IEC 60947-3			
Clause	Requirement + Test	Result - Remark	Verdict
8.3.3.1	<b>TABLE: Temperature-rise (measurements)</b> (Sample No. 5: $I_e = 25$ A)		P
Temperature rise dT of part:		dT (K) measured	dT (K) required
Above terminals (cable connection)		44,3	70
Below terminals (cable connection)		42,9	70
Manual operating means: metallic / non-metallic		10,6	25
Parts intended to be touched but not hand-held: metallic / non-metallic		13,3	40
Parts which need not be touched during normal operation: metallic / non-metallic		15,2	50
<b>supplementary information:</b>		Ambient temperature:	22,7 °C

8.3.3.6	<b>TABLE: Temperature-rise (measurements)</b> (Sample No. 5: $I_e = 25$ A)		P
Temperature rise dT of part:		dT (K) measured	dT (K) required
Terminals		47,5	80
Manual operating means: metallic / non-metallic		8,9	35
Parts intended to be touched but not hand-held: metallic / non-metallic		16,2	50
Parts which need not be touched during normal operation: metallic / non-metallic		22,8	60
<b>supplementary information:</b>		Ambient temperature:	22,9 °C

8.3.3.1	<b>TABLE: Temperature-rise (measurements)</b> (Sample No. 6: $I_e = 10$ A)		P
Temperature rise dT of part:		dT (K) measured	dT (K) required
Above terminals (cable connection)		44,5	70
Below terminals (cable connection)		40,8	70
Manual operating means: metallic / non-metallic		9,3	25
Parts intended to be touched but not hand-held: metallic / non-metallic		19,5	40
Parts which need not be touched during normal operation: metallic / non-metallic		14,8	50
<b>supplementary information:</b>		Ambient temperature:	22,7 °C

TRF No. IEC60947\_3B

ВЯРНО С  
ОРИГИНАЛА

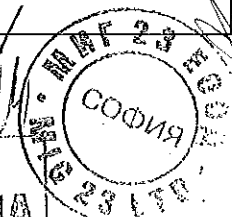

1076

IEC 60947-3			
Clause	Requirement + Test	Result - Remark	Verdict

8.3.3.6	TABLE: Temperature-rise (measurements) (Sample No. 6: $I_e = 10$ A)	P	
Temperature rise dT of part:		dT (K) measured	dT (K) required
Terminals		50,4	80
Manual operating means: metallic / non-metallic		6,3	35
Parts intended to be touched but not hand-held: metallic / non-metallic		13,8	50
Parts which need not be touched during normal operation: metallic / non-metallic		27,0	60
<b>supplementary information:</b>		Ambient temperature:	23,8 °C

8.3.3.1	TABLE: Temperature-rise (measurements) (Sample No. 7: $I_e = 32$ A)	P	
Temperature rise dT of part:		dT (K) measured	dT (K) required
Above terminals (cable connection)		63,8	70
Below terminals (cable connection)		63,9	70
Manual operating means: metallic / non-metallic		16,9	25
Parts intended to be touched but not hand-held: metallic / non-metallic		32,8	40
Parts which need not be touched during normal operation: metallic / non-metallic		22,3	50
<b>supplementary information:</b>		Ambient temperature:	22,7 °C

8.3.3.6	TABLE: Temperature-rise (measurements) (Sample No. 7: $I_e = 32$ A)	P	
Temperature rise dT of part:		dT (K) measured	dT (K) required
Terminals		59,9	80
Manual operating means: metallic / non-metallic		11,2	35
Parts intended to be touched but not hand-held: metallic / non-metallic		23,7	50
Parts which need not be touched during normal operation: metallic / non-metallic		27,6	60
<b>supplementary information:</b>		Ambient temperature:	24,4 °C

TRF No. IEC60947\_3B



IEC 60947-3			
Clause	Requirement + Test	Result - Remark	Verdict

8.3.4.4	TABLE: Temperature-rise (measurements) (Sample No. 8: I <sub>e</sub> = 25 A)		P
Temperature rise dT of part:		dT (K) measured	dT (K) required
Terminals		39,6	80
Manual operating means: metallic / non-metallic		5,5	35
Parts intended to be touched but not hand-held: metallic / non-metallic		17,6	50
Parts which need not be touched during normal operation: metallic / non-metallic		25,9	60
supplementary information:		Ambient temperature: 25,3 °C	

8.3.4.4	TABLE: Temperature-rise (measurements) (Sample No. 9: I <sub>e</sub> = 10 A)		P
Temperature rise dT of part:		dT (K) measured	dT (K) required
Terminals		43,1	80
Manual operating means: metallic / non-metallic		3,3	35
Parts intended to be touched but not hand-held: metallic / non-metallic		14,0	50
Parts which need not be touched during normal operation: metallic / non-metallic		20,3	60
supplementary information:		Ambient temperature: 25,3 °C	

8.3.4.4	TABLE: Temperature-rise (measurements) (Sample No. 10: I <sub>e</sub> = 32 A)		P
Temperature rise dT of part:		dT (K) measured	dT (K) required
Terminals		47,5	80
Manual operating means: metallic / non-metallic		10,8	35
Parts intended to be touched but not hand-held: metallic / non-metallic		24,4	50
Parts which need not be touched during normal operation: metallic / non-metallic		26,1	60
supplementary information:		Ambient temperature: 25,3 °C	

ВЯРНО С  
ОРИГИНАЛА

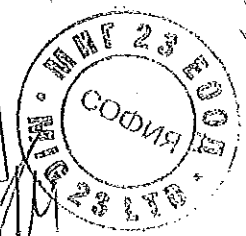

1078



IEC 60947-3			
Clause	Requirement + Test	Result - Remark	Verdict

8.3.4.4	TABLE: Temperature-rise (measurements) (Sample No. 11: $I_b = 32$ A)		P
Temperature rise dT of part:		dT (K) measured	dT (K) required
Terminals		42,5	80
Manual operating means: <del>metallie</del> / non-metallic		9,2	35
Parts intended to be touched but not hand-held: <del>metallie</del> / non-metallic		22,1	50
Parts which need not be touched during normal operation: <del>metallie</del> / non-metallic		22,5	60
<b>supplementary information:</b>		Ambient temperature: 25,3 °C	

8.3.4.4	TABLE: Temperature-rise (measurements) (Sample No. 12: $I_b = 25$ A)		P
Temperature rise dT of part:		dT (K) measured	dT (K) required
Terminals		48,9	80
Manual operating means: <del>metallie</del> / non-metallic		8,4	35
Parts intended to be touched but not hand-held: <del>metallie</del> / non-metallic		28,8	50
Parts which need not be touched during normal operation: <del>metallie</del> / non-metallic		30,4	60
<b>supplementary information:</b>		Ambient temperature: 25,3 °C	

8.3.4.4	TABLE: Temperature-rise (measurements) (Sample No. 13: $I_b = 10$ A)		P
Temperature rise dT of part:		dT (K) measured	dT (K) required
Terminals		43,8	80
Manual operating means: <del>metallie</del> / non-metallic		9,3	35
Parts intended to be touched but not hand-held: <del>metallie</del> / non-metallic		28,5	50
Parts which need not be touched during normal operation: <del>metallie</del> / non-metallic		28,7	60
<b>supplementary information:</b>		Ambient temperature: 25,3 °C	

TRF No: IEC60947\_3B



IEC 60947-3			
Clause	Requirement + Test	Result - Remark	Verdict

8.3.4.4	TABLE: Temperature-rise (measurements) (Sample No. 14: $I_e = 32$ A)		P
Temperature rise dT of part:		dT (K) measured	dT (K) required
Terminals		44,1	80
Manual operating means: metallic / non-metallic		14,5	35
Parts intended to be touched but not hand-held: metallic / non-metallic		34,0	50
Parts which need not be touched during normal operation: metallic / non-metallic		23,3	60
<b>supplementary information:</b>		Ambient temperature: 25,3 °C	

8.3.5.5	TABLE: Temperature-rise (measurements)		N/A
Temperature rise dT of part:		dT (K) measured	dT (K) required
Terminals			
Manual operating means: metallic / non-metallic			
Parts intended to be touched but not hand-held: metallic / non-metallic			
Parts which need not be touched during normal operation: metallic / non-metallic			
<b>supplementary information:</b>			

8.3.6.5	TABLE: Temperature-rise (measurements) (Sample No. 15: $I_e = 32$ A)		P
Temperature rise dT of part:		dT (K) measured	dT (K) required
Terminals		53,5	80
Manual operating means: metallic / non-metallic		6,0	35
Parts intended to be touched but not hand-held: metallic / non-metallic		16,8	50
Parts which need not be touched during normal operation: metallic / non-metallic		26,3	60
<b>supplementary information:</b>		Ambient temperature: 23,5 °C	

TRF No. IEC60947\_3B

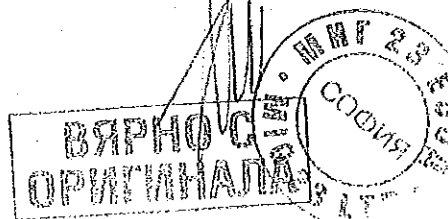

IEC 60947-3			
Clause	Requirement + Test	Result - Remark	Verdict
8.3.6.5	<b>TABLE: Temperature-rise (measurements)</b> (Sample No. 16: $I_e = 32$ A)		P
Temperature rise dT of part:		dT (K) measured	dT (K) required
Terminals		58,5	80
Manual operating means: <del>metallie</del> / non-metallic		10,2	35
Parts intended to be touched but not hand-held: <del>metallie</del> / non-metallic		21,8	50
Parts which need not be touched during normal operation: <del>metallie</del> / non-metallic		40,5	60
<b>supplementary information:</b>		Ambient temperature:	24,9 °C

8.3.6.5	<b>TABLE: Temperature-rise (measurements)</b> (Sample No. 17: $I_e = 32$ A)		P
Temperature rise dT of part:		dT (K) measured	dT (K) required
Terminals		65,9	80
Manual operating means: <del>metallie</del> / non-metallic		14,1	35
Parts intended to be touched but not hand-held: <del>metallie</del> / non-metallic		28,4	50
Parts which need not be touched during normal operation: <del>metallie</del> / non-metallic		44,7	60
<b>supplementary information:</b>		Ambient temperature:	24,6 °C

8.3.6.5	<b>TABLE: Temperature-rise (measurements)</b> (Sample No. 18: $I_e = 32$ A)		P
Temperature rise dT of part:		dT (K) measured	dT (K) required
Terminals		60,3	80
Manual operating means: <del>metallie</del> / non-metallic		16,6	35
Parts intended to be touched but not hand-held: <del>metallie</del> / non-metallic		35,0	50
Parts which need not be touched during normal operation: <del>metallie</del> / non-metallic		33,5	60
<b>supplementary information:</b>		Ambient temperature:	24,2 °C

IEC 60947-3			
Clause	Requirement + Test	Result - Remark	Verdict

8.3.6.5	TABLE: Temperature-rise (measurements) (Sample No. 19: I <sub>e</sub> = 25 A)		P
Temperature rise dT of part:		dT (K) measured	dT (K) required
Terminals		35,6	80
Manual operating means: metallic / non-metallic		6,5	35
Parts intended to be touched but not hand-held: metallic / non-metallic		15,7	50
Parts which need not be touched during normal operation: metallic / non-metallic		22,0	60
<b>supplementary information:</b>		Ambient temperature: 24,6 °C	

8.3.6.5	TABLE: Temperature-rise (measurements) (Sample No. 20: I <sub>e</sub> = 25 A)		P
Temperature rise dT of part:		dT (K) measured	dT (K) required
Terminals		42,1	80
Manual operating means: metallic / non-metallic		8,6	35
Parts intended to be touched but not hand-held: metallic / non-metallic		19,1	50
Parts which need not be touched during normal operation: metallic / non-metallic		24,3	60
<b>supplementary information:</b>		Ambient temperature: 24,6 °C	

8.3.6.5	TABLE: Temperature-rise (measurements) (Sample No. 21: I <sub>e</sub> = 25 A)		P
Temperature rise dT of part:		dT (K) measured	dT (K) required
Terminals		46,6	80
Manual operating means: metallic / non-metallic		12,9	35
Parts intended to be touched but not hand-held: metallic / non-metallic		26,5	50
Parts which need not be touched during normal operation: metallic / non-metallic		28,2	60
<b>supplementary information:</b>		Ambient temperature: 24,6 °C	

TRF No. IEC60947\_3B



1780

IEC 60947-3			
Clause	Requirement + Test	Result - Remark	Verdict
8.3.6.5	TABLE: Temperature-rise (measurements) (Sample No. 22: $I_b = 25$ A)		P
Temperature rise dT of part:		dT (K) measured	dT (K) required
Terminals		57,7	80
Manual operating means: metallic / non-metallic		16,8	35
Parts intended to be touched but not hand-held: metallic / non-metallic		33,8	50
Parts which need not be touched during normal operation: metallic / non-metallic		30,6	60
supplementary information:		Ambient temperature:	24,6 °C

8.3.6.5	TABLE: Temperature-rise (measurements) (Sample No. 23: $I_b = 10$ A)		P
Temperature rise dT of part:		dT (K) measured	dT (K) required
Terminals		33,5	80
Manual operating means: metallic / non-metallic		3,5	35
Parts intended to be touched but not hand-held: metallic / non-metallic		13,0	50
Parts which need not be touched during normal operation: metallic / non-metallic		19,0	60
supplementary information:		Ambient temperature:	23,3 °C

8.3.6.5	TABLE: Temperature-rise (measurements) (Sample No. 24: $I_b = 10$ A)		P
Temperature rise dT of part:		dT (K) measured	dT (K) required
Terminals		31,9	80
Manual operating means: metallic / non-metallic		6,1	35
Parts intended to be touched but not hand-held: metallic / non-metallic		17,1	50
Parts which need not be touched during normal operation: metallic / non-metallic		19,3	60
supplementary information:		Ambient temperature:	23,3 °C



IEC 60947-3			
Clause	Requirement + Test	Result - Remark	Verdict

8.3.6.5	TABLE: Temperature-rise (measurements) (Sample No. 25: I <sub>e</sub> = 10 A)		P
Temperature rise dT of part:		dT (K) measured	dT (K) required
Terminals		45,7	80
Manual operating means: metallic / non-metallic		8,4	35
Parts intended to be touched but not hand-held: metallic / non-metallic		24,1	50
Parts which need not be touched during normal operation: metallic / non-metallic		25,3	60
<b>supplementary information:</b>		Ambient temperature:	23,3 °C

8.3.6.5	TABLE: Temperature-rise (measurements) (Sample No. 26: I <sub>e</sub> = 32 A)		P
Temperature rise dT of part:		dT (K) measured	dT (K) required
Terminals		56,8	80
Manual operating means: metallic / non-metallic		13,5	35
Parts intended to be touched but not hand-held: metallic / non-metallic		33,0	50
Parts which need not be touched during normal operation: metallic / non-metallic		30,8	60
<b>supplementary information:</b>		Ambient temperature:	24,6 °C

8.3.7.4	TABLE: Temperature-rise (measurements) (Sample No. 27: I <sub>e</sub> = 32 A)		P
Temperature rise dT of part:		dT (K) measured	dT (K) required
Terminals		42,5	80
Manual operating means: metallic / non-metallic		2,8	35
Parts intended to be touched but not hand-held: metallic / non-metallic		14,0	50
Parts which need not be touched during normal operation: metallic / non-metallic		21,6	60
<b>supplementary information:</b>		Ambient temperature:	22,6 °C

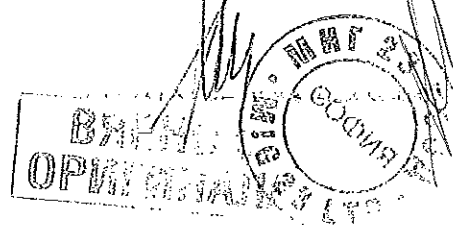

IEC 60947-3			
Clause	Requirement + Test	Result - Remark	Verdict

8.3.7.4	TABLE: Temperature-rise (measurements) (Sample No. 28: I <sub>e</sub> = 32 A)		P
Temperature rise dT of part:		dT (K) measured	dT (K) required
Terminals		46,8	80
Manual operating means: metallic / non-metallic		11,7	35
Parts intended to be touched but not hand-held: metallic / non-metallic		31,8	50
Parts which need not be touched during normal operation: metallic / non-metallic		35,4	60
<b>supplementary information:</b>		Ambient temperature:	23,4 °C

8.3.7.4	TABLE: Temperature-rise (measurements) (Sample No. 29: I <sub>e</sub> = 32 A)		P
Temperature rise dT of part:		dT (K) measured	dT (K) required
Terminals		53,6	80
Manual operating means: metallic / non-metallic		17,5	35
Parts intended to be touched but not hand-held: metallic / non-metallic		33,4	50
Parts which need not be touched during normal operation: metallic / non-metallic		41,5	60
<b>supplementary information:</b>		Ambient temperature:	23,8 °C

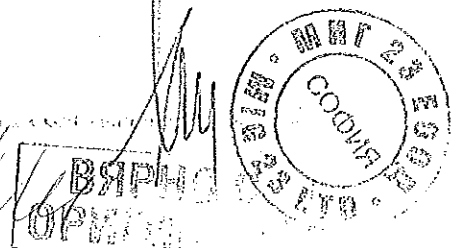





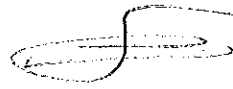

**wöhner**  
ALLES MIT SPANNUNG

## Herstellereklärung

zur Baumusterkonformität der Sicherungshalter für zylindrische Sicherungen in den Bauartausführungen der Hersteller Wöhner GmbH & Co. KG und OEZ, s.r.o.,

Wöhner GmbH & Co. KG	OEZ s.r.o.	
Wöhner Nr.	ID code	ITEM
31.971.062	41003	OPVF10-1
31.974.062	41004	OPVF10-2
31.110.162	41005	OPVA10-1
31.130.162	41006	OPVA10-1-S
31.111.162	41007	OPVA10-1N
31.112.162	41008	OPVA10-2
31.132.162	41009	OPVA10-2-S
31.113.162	41010	OPVA10-3
31.133.162	41011	OPVA10-3-S
31.114.162	41012	OPVA10-3N
31.275.062	41013	OPVP10-1
31.276.062	41014	OPVP10-2
31.277.062	41015	OPVP10-3
31.115.162	41016	OPVA14-1
31.135.162	41017	OPVA14-1-S
31.116.162	41018	OPVA14-1N
31.117.162	41019	OPVA14-2
31.137.162	41020	OPVA14-2-S
31.118.162	41021	OPVA14-3
31.138.162	41022	OPVA14-3-S
31.119.162	41023	OPVA14-3N
31.278.062	41024	OPVP14-1
31.279.062	41025	OPVP14-2
31.280.062	41026	OPVP14-3
31.120.162	41027	OPVA22-1
31.140.162	41028	OPVA22-1-S
31.121.162	41029	OPVA22-1N
31.122.162	41030	OPVA22-2





31.142.162	41031	OPVA22-2-S
31.123.162	41032	OPVA22-3
31.143.162	41033	OPVA22-3-S
31.124.162	41034	OPVA22-3N
31.281.062	41035	OPVP22-1
31.282.062	41036	OPVP22-2
31.283.062	41037	OPVP22-3

Fertigungsstätte für die oben genannten Sicherungshalter:

Wöhner GmbH & Co. KG  
Mönchrödener Strasse 10  
D - 96472 Rödental

VDE-Aktenzeichen

DE1-49452 249800-4402-0705/152633 (10x38)  
DE1-29569 249800-4402-0705/26504 (14x51)  
DE1-50312 249800-4402-0708/158641 (22x58)

Zurzeit noch in Bearbeitung (10x38 PV)

Hiermit erklären wir, dass die oben genannten Sicherungshalter der Hersteller Wöhner GmbH & Co. KG und OEZ, s.r.o. in der angegebenen Fertigungsstätte nach denselben Zeichnungen gefertigt werden.

Wir bestätigen, dass die Sicherungshalter auch unter dem Firmennamen OEZ, s.r.o. vertrieben werden können.

Beide Geräteausführungen besitzen einen identischen Aufbau bezüglich der Konstruktion und des verwendeten Materials und unterscheiden sich nur im äußeren Design und in den Aufschriften.

Rödental, den 28.06.2012

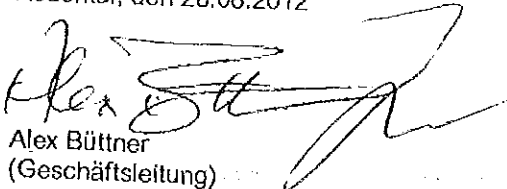
  
Alex Büttner  
(Geschäftsleitung)

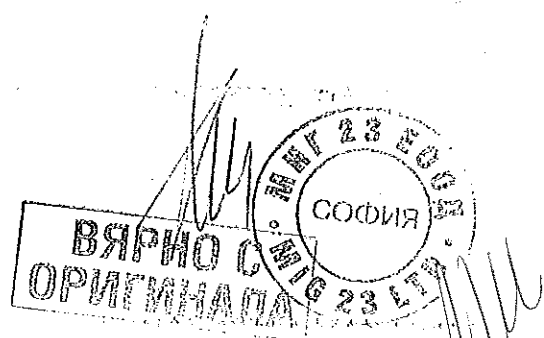
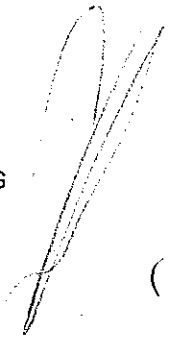

*S*

**Списък на изпитванията от типови изпитания:**

• Техническа характеристика

- Тип Код;
- Номинално напрежение;
- Номинален ток;
- Номинална честота;
- Номинална изключвателна възможност;
- Размер.

• Типов тест;

- Рутинен тест;
  - Тестване на образци;
  - Съответствие с изискванията за конструкции;
- h*

**ВЯРНО С  
ОРИГИНАЛА**

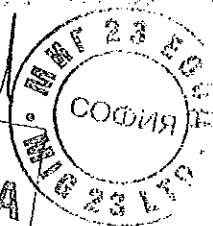

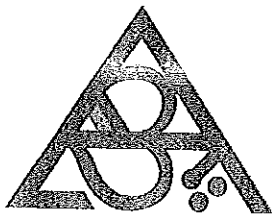

NÁRODNÍ AKREDITAČNÍ ORGÁN

Signatář EA MLA  
Český institut pro akreditaci, o.p.s.  
Olšanská 54/3, 130 00 Praha 3

vydává

v souladu s § 16 zákona č. 22/1997 Sb., o technických požadavcích na výrobky, ve znění pozdějších předpisů

# OSVĚDČENÍ O AKREDITACI

č. 15 / 2015

Elektrotechnický zkušební ústav, s.p.  
se sídlem Pod Lisem 129, 171 02 Praha 8 - Troja, IČ 00001481

pro zkušební laboratoř č. 1056  
Zkušební laboratoř

Rozsah udělené akreditace:

Zkoušení výrobků, dílů, součástí, materiálů a pomůcek vymezené přílohou tohoto osvědčení.

Toto osvědčení je dokladem o udělení akreditace na základě posouzení splnění akreditačních požadavků podle

ČSN EN ISO/IEC 17025:2005

Subjekt posuzování shody je při své činnosti oprávněn odkazovat se na toto osvědčení v rozsahu udělené akreditace po dobu její platnosti, pokud nebude akreditace pozastavena, a je povinen plnit stanovené akreditační požadavky v souladu s příslušnými předpisy vztahujícími se k činnosti akreditovaného subjektu posuzování shody.

Toto osvědčení o akreditaci nahrazuje v plném rozsahu osvědčení č.: 744/2013 ze dne 19.12.2013, popřípadě správní akty na ně navazující.

Udělení akreditace je platné do 15.10.2017

V Praze dne 08.01.2015

Ing. Jiří Růžička, MBA  
ředitel  
Českého institutu pro akreditaci, o.p.s.

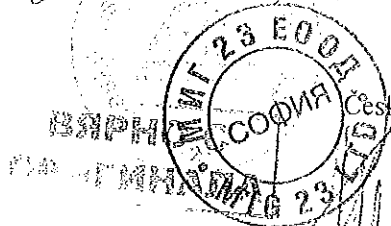

**Наименование на материала:**



**Триполюсни автоматични прекъсвачи  
НН с лят корпус, от 160 А до 1250 А, с  
електронна защита, категория А**

**Номер на техническа спецификация на  
стандарт - 20 17 60zzкъм**

**МКТП(П) 20/800(630) – Т53**

**и**

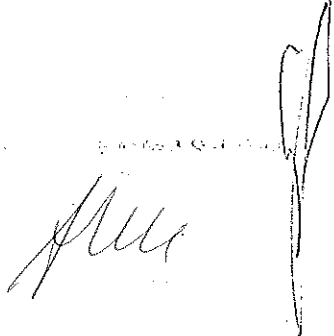
**МКТП(П)-20/2x800(630) – Т56**



№ по ред	Документ	Приложение № или текст
1.	Точно означение на типа, производителя и страната на производство (произход) и последно издание на каталога на производителя	Susol, LS Industrial Systems, Южна Корея, TS 1250H  Приложение 1
2.	Техническо описание и чертежи с нанесени на тях размери	Приложение 2
3.	ЕО декларация за съответствие	Приложение 3
4.	Протоколи от типови изпитвания на английски или български език, проведени от независима изпитвателна лаборатория – заверени копия, с приложен списък на отделните изпитвания на български език	Приложение 4
5.	Сертификат/акредитация на независимата изпитвателна лаборатория, провела типовите изпитвания по т. 4 – заверено копие	Приложение 5
6.	Техническо описание и чертежи с нанесени размери на монтажни планки, единичната цена на които не се включва в цената на прекъсвачите	Не са необходими монтажни планки

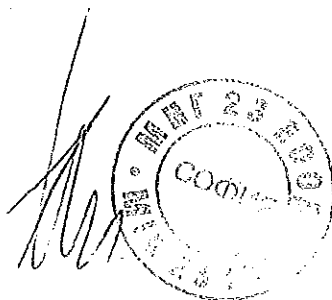

Handwritten signature.

Handwritten signature.

# MCCBs for power distribution up to 1600A

Susol

## Electrical characteristics

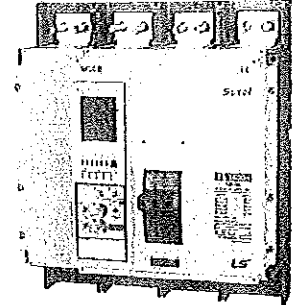
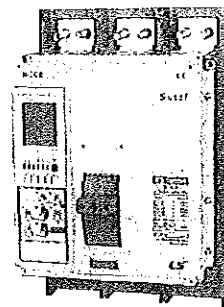

Type			
Ampere frame			
Pole			
Rated current, (A)	In	-5~40°C	
		50°C	
		65°C	
Rated insulation voltage, (V)	Ui		
Rated impulse withstand voltage, (kV)	UImp		
Rated operational voltage, (V)	Ue	AC50/60Hz	
		DC	
Rated short-circuit breaking capacity			
IEC60947-2 AC50/60Hz (sym)	Rated ultimate short-circuit breaking capacity, (kA) (Icu)	220/240V	
		380/415V	
		440/460V	
		480/500V	
		660/690V	
DC	%Icu	250V 2P	
		500V 2P	
		750V 3P	
Rated service breaking capacity (Ics)	%Icu		
Rated short-circuit making capacity (kA) (Icw)	AC50/60Hz	1s	
		3s	
Overriding instantaneous protection	kA peak		
Isolation			
Category			
(Life cycle)	Mechanical life (operations)	440V	In/2
			In
	Electrical life (operations)	690V	In/2
			In
Pollution degree			
Dimension (mm)	3-pole		
	4-pole		
Weight (kg)	3-pole		
	4-pole		

TS1000			TS1250			TS1600	
TS1000			TS1250			TS1600	
1000			1250			1600	
3, 4			3, 4			3, 4	
800, 1000			1250			1600	
800, 1000			1250			1560	
800, 1000			1240			1420	
1000			1000			1000	
8			8			8	
690			690			690	
-			-			-	
N	H	L	N	H	N	H	
55	75	200	55	75	55	75	
50	70	150	50	70	50	70	
50	65	130	50	65	50	65	
40	50	100	40	50	40	50	
35	45	50	35	45	35	45	
-	-	-	-	-	-	-	
-	-	-	-	-	-	-	
-	-	-	-	-	-	-	
100%	75%	100%	100%	75%	100%	75%	
25		12		25		25	
-		-		-		-	
50		30		50		50	
O		O		O		O	
B		A		B		B	
10000		4000		10000		10000	
6000		4000		5000		5000	
5000		3000		4000		2000	
4000		3000		3000		2000	
2000		2000		2000		1000	
3		3		3		3	
				327×210×152.5			
				327 280 152.5			
				13			
				16.8			

A-2-65

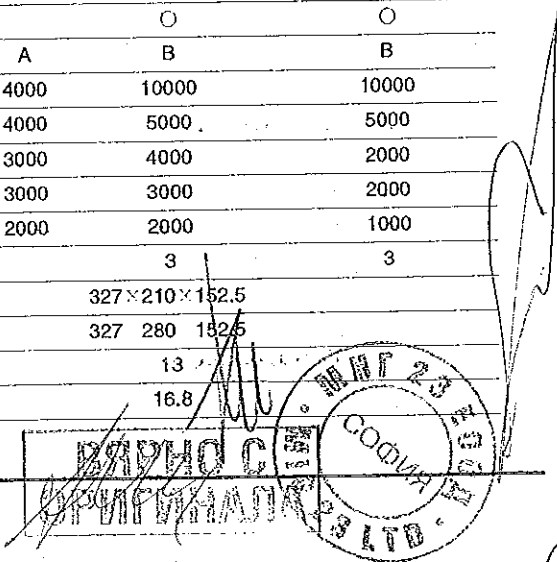

681

## ТЕХНИЧЕСКО ОПИСАНИЕ

### I. Триполюсни автоматични и товарови прекъсвачи серия Susol 1250A,

Автоматични прекъсвачи серия Susol TS са произведени от фирма LS Industrial Systems и представляват механични комутационни апарати, способни да провеждат и да включват/изключват ръчно електрически токове до 1250 А във вериги при нормални условия и да провеждат за определено време и да изключват автоматично токове във вериги при условията на претоварване и късо съединение.

Тялото на автоматични прекъсвачи е изработено чрез формоване на устойчив на нагряване, на огън и на механични удари изолационен материал. В монтирано състояние съгласно инструкциите на производителя и след опроводяване активните части на миниатюрните автоматични прекъсвачи не са достъпни.

При вертикално монтиране на автоматични и товарови прекъсвачи лостът се движи в направление „нагоре - надолу“, при което контактите се затварят при движение „нагоре“. Автоматични прекъсвачи са снабдени с ясно видимо от челната страна средство за указване на затвореното и отвореното положение на контактната система- Означение „ON/OFF“ върху лоста за управление. При задействане на защитата (или натискане на специален бутон на лицевата страна) лоста застава в „Trip“ положение, което е оказано със символ на челната страна. За да се включи прекъсвача от „Trip“ положение лостът първо трябва да се придвижи надолу към положение „OFF“, а след това нагоре до положение „ON“. Устройствата отговарят на следните стандарти: EN/IEC 60947-1, EN/IEC 60947-2, EN/IEC 60947-3, EN/IEC 60947-4.

Прекъсвачите са маркирани с CE маркировка за съответствие и на лицевия панел на устройството са отпечатани следните основни параметри:

- Разривен ток при различни напрежения
- Допустимо импулсно напрежение на изолацията
- Номинален ток
- Номинално напрежение
- Краткотрайно издържан ток
- Работна изключвателна възможност

Автоматични и товарови прекъсвачи серия Susol са снабдени с ротационна контактна система и имат повишена изключвателна възможност поради двойното разкъсване всеки полюс.

Ротационната контактна система има следните преимущества:

- Двойно разкъсване на всеки полюс
- Мигновено отвеждане на дъгата към дъгогасителните камери
- Повишава дълготрайността на контактите като ги предпазва от износване
- Отлични токоограничаващи свойства
- Висока изключвателна възможност при компатни размери



ВЯРНО С  
ОРИГИНАЛА

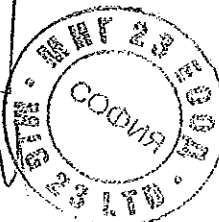



# TS 1000, 1250, 1600A

## Front Type

[mm]

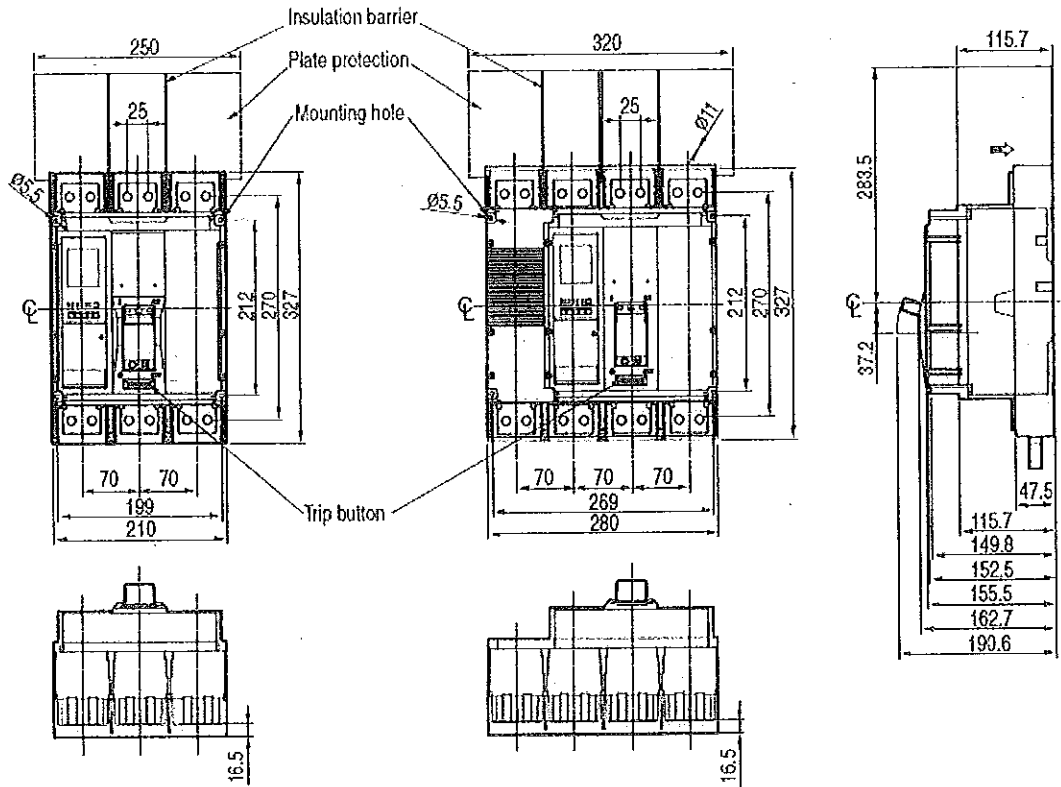

*[Handwritten signature]*

ВЯРНО С  
ОРИГИНАЛА

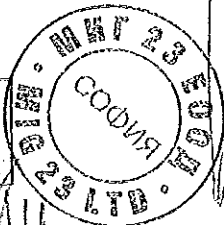

*[Handwritten signature]*

ДЕКЛАРАЦИЯ ЗА СЪОТВЕТСТВИЕ

Долуподписаният Владимир Лазаров,

Управител на фирма "ВиВ Изоматик" ООД, София, ул. Пирин 40А

В качеството си на търговски представители на LS Industrial Systems Co., Ltd.

Декларираме, че продуктът:

Марка: LS Industrial Systems  
Продукт: Автоматичен прекъсвач  
TS1000N, TS1250N, TS1600N  
TS1000H, TS1250H, TS1600H  
TS1000L, TS1250L, TS1600L  
TS1000NA, TS1250NA, TS1600NA  
Серия: SuSol

За който се отнася тази декларация, при условие, че е инсталиран, обслужван и използван за приложения, за които е предназначен, е в съответствие със следните стандарти, технически одобрения или други нормативни актове:

IEC 60947-1  
IEC 60947-2

София, 18.01.2012

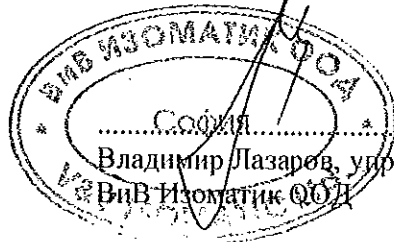

Владимир Лазаров, управител  
ВиВ Изоматик ООД

ВЯРНО С  
ОРИГИНАЛА

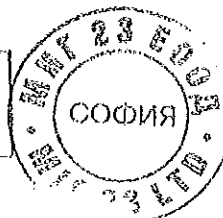

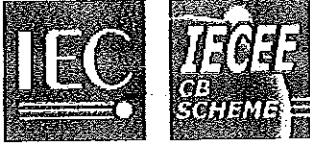

# CB TEST CERTIFICATE

Ref. Certificate No.

NL-20335

## IEC SYSTEM FOR MUTUAL RECOGNITION OF TEST CERTIFICATES FOR ELECTRICAL EQUIPMENT (IECEE) CB SCHEME

Issued by: DEKRA Certification B.V.

Product: Moulded-case circuit-breaker

Applicant: LS Industrial Systems Co., Ltd. 1026-6, Hogye-dong, Dong-an-gu Anyang-si, Gyeonggi-do Korea, Republic of

Manufacturer: LS Industrial Systems Co., Ltd. 1026-6, Hogye-dong, Dong-an-gu Anyang-si, Gyeonggi-do Korea, Republic of

Factory: LS Industrial Systems Co., Ltd. 1026-6, Hogye-dong, Dong-an-gu Anyang-si, Gyeonggi-do Korea, Republic of

Rating and principal characteristics: 3P/3P+N MCCB (electronic); Ue = 220/240, 380/415, 440/460, 480/500, 660/690 V; Ie = 630, 800, 1000, 1250, 1600 A; Uimp = 8 kV; Ui = 1000 V; TS1000H, TS1250H, TS1600H; Icu = 75 kA at 220/240 V, 70 kA at 380/415 V, 65 kA at 440/460 V, 50 kA at 480/500 V, 45 kA at 660/690 V; Ics = 75% of Icu; Icw = 25 kA – 1 s; TS1000N, TS1250N, TS1600N; Icu = 55 kA at 220/240 V, 50 kA at 380/415 V, 50 kA at 440/460 V, 40 kA at 480/500 V, 35 kA at 660/690 V; Ics = 100% of Icu; Icw = 25 kA – 1 s; IP30; 50/60 Hz; Utilization category B;

Trade mark (if any): LS

Type of Manufacturer's Testing Laboratories used: WMT

Model/Type reference: TS1000N, TS1250N, TS1600N, TS1000H, TS1250H, TS1600H

Additional information: -

Sample of product tested to be in conformity with IEC: 60947-2(ed.4);am1

Test Report Ref. No: 2131728.51

This CB Test Certificate is issued by the National Certification Body:

DEKRA Certification B.V.  
Utrechtseweg 310  
P.O. Box 5185  
6802 ED Arnhem  
The Netherlands

Signed by: H.B.M. Barends

Date of issue: 2011-04-19



DEKRA Certification is former KEMA Quality



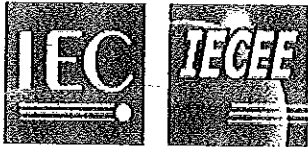

Test Report issued under the responsibility of:



<b>TEST REPORT</b> <b>IEC 60947-2</b> <b>Low-voltage switchgear and controlgear - Part 2: Circuit-breakers</b>	
Report Reference No.....	2131728.51
Date of issue.....	2011-04-19
Total number of pages .....	133
CB Testing Laboratory.....	DEKRA Certification B.V.
Address .....	Utrechtseweg 310, 6812 ARNHEM, The Netherlands
Applicant's name.....	LS Industrial Systems Co., Ltd.
Address .....	1026-6, Hogye-dong, Dong-an-gu Anyang-si, Gyeonggi-do, Korea
<b>Test specification:</b>	
Standard .....	IEC 60947-2:2006 (4 <sup>th</sup> Edition) + amendment 1: 2009
Test procedure .....	CB
Non-standard test method.....	N/A
Test Report Form No.....	IEC60947_2F
Test Report Form(s) Originator .....	KEMA Quality BV
Master TRF .....	Dated 2010-01
<b>Copyright © 2010 IEC System for Conformity Testing and Certification of Electrical Equipment (IECEE), Geneva, Switzerland. All rights reserved.</b>	
This publication may be reproduced in whole or in part for non-commercial purposes as long as the IECEE is acknowledged as copyright owner and source of the material. IECEE takes no responsibility for and will not assume liability for damages resulting from the reader's interpretation of the reproduced material due to its placement and context.	
If this Test Report Form is used by non-IECEE members, the IECEE/IEC logo and the reference to the CB Scheme procedure shall be removed.	
<b>This report is not valid as a CB Test Report unless signed by an approved CB Testing Laboratory and appended to a CB Test Certificate issued by an NCB in accordance with IECEE 02.</b>	
Test item description .....	Moulded-case circuit-breaker
Trade Mark .....	LS
Manufacturer .....	LS Industrial Systems Co., Ltd.
Model/Type reference.....	TS1000N, TS1250N, TS1600N, TS1000H, TS1250H, TS1600H
Ratings .....	630, 800, 1000, 1250, 1600 A

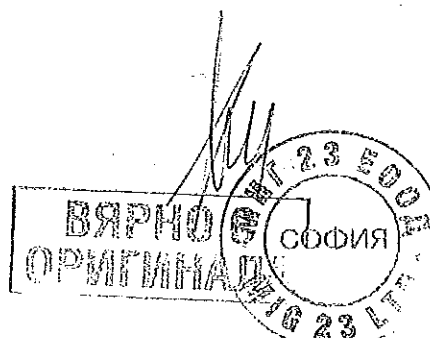

**Testing procedure and testing location:**

**CB Testing Laboratory:**  
 Testing location/ address.....:

**Associated CB Laboratory:**  
 Testing location/ address.....:

Tested by (name + signature).....:  
 Approved by (+ signature) .....

**Testing procedure: TMP**  
 Tested by (name + signature).....:  
 Approved by (+ signature) .....

Testing location/ address.....:

**Testing procedure: WMT**  
 Tested by (name + signature).....: Oh Junsick  
 Witnessed by (+ signature).....: F.S.Strikwerda  
 Approved by (+ signature) .....

H.G.M. Kormelink  
 Testing location/ address.....: LS Industrial Systems, Co., Ltd. CheongJu Plant  
 1, Songjeong-dong, Heungdeok-gu Cheongju-si,  
 Chungcheongbuk-do, Korea

**Testing procedure: SMT**  
 Tested by (name + signature).....:  
 Approved by (+ signature) .....

Supervised by (+ signature).....:  
 Testing location/ address.....:

**Testing procedure: RMT**  
 Tested by (name + signature).....:  
 Approved by (+ signature) .....

Supervised by (+ signature).....:  
 Testing location/ address.....:

*[Handwritten signature]*

TRF No. IEC60947\_2F

*[Handwritten signature]*

ВЕРНО С  
ОРИГИНАЛ

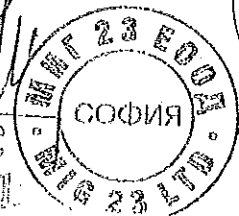

**Summary of testing:**

**Tests performed (name of test and test clause):**

8.3.3 Test sequence I: General performance characteristics

8.3.4 Test sequence II: Rated service short-circuit breaking capacity

8.3.5 Test sequence III: Rated ultimate short-circuit breaking capacity

8.3.6 Test sequence IV: Rated short-time withstand current

Annex F : Additional tests for circuit-breakers with electronic over-current protection

4pole is covered by tests of Annex F on the TS1600H 3pole because the construction is identical.

Annex H: Test sequence for circuit-breakers for IT systems.

4pole is covered by tests of Annex H on the TS1600H 3pole because the construction is identical.

Ground fault release was not tested because the min. fault current is > 30A

H-type covers the N-type because the construction is identical, only difference in marking

**Testing location:**

LS Industrial Systems Co., Ltd. Cheongju Plant  
 1, Songjeong-dong, Heungdeok-gu Cheongju-si, Chungcheongbuk-do, Korea, Republic Of

**Summary of compliance with National Differences: N/A**

**Copy of marking plate**

<p><b>TS 1600N</b> 1630A UI 1000V Ulmp 8kV</p> <table border="1"> <tr><th>Ue(V)</th><th>Icu(kA)</th></tr> <tr><td>220/240</td><td>~ 55kA</td></tr> <tr><td>380/415</td><td>~ 55kA</td></tr> <tr><td>440/480</td><td>~ 55kA</td></tr> <tr><td>480/500</td><td>~ 40kA</td></tr> <tr><td>660/690</td><td>~ 35kA</td></tr> </table> <p>Icu = 100% Icu Icw = 25kA/1s</p> <p>IEC 60947-2 Cat.B LS Industrial Systems MADE IN KOREA</p>	Ue(V)	Icu(kA)	220/240	~ 55kA	380/415	~ 55kA	440/480	~ 55kA	480/500	~ 40kA	660/690	~ 35kA	<p><b>TS 1250N</b> 1250A UI 1000V Ulmp 8kV</p> <table border="1"> <tr><th>Ue(V)</th><th>Icu(kA)</th></tr> <tr><td>220/240</td><td>~ 65kA</td></tr> <tr><td>380/415</td><td>~ 50kA</td></tr> <tr><td>440/480</td><td>~ 50kA</td></tr> <tr><td>480/500</td><td>~ 40kA</td></tr> <tr><td>660/690</td><td>~ 35kA</td></tr> </table> <p>Icu = 100% Icu Icw = 25kA/1s</p> <p>IEC 60947-2 Cat.B LS Industrial Systems MADE IN KOREA</p>	Ue(V)	Icu(kA)	220/240	~ 65kA	380/415	~ 50kA	440/480	~ 50kA	480/500	~ 40kA	660/690	~ 35kA	<p><b>TS 1000N</b> 1000A UI 1000V Ulmp 8kV</p> <table border="1"> <tr><th>Ue(V)</th><th>Icu(kA)</th></tr> <tr><td>220/240</td><td>~ 55kA</td></tr> <tr><td>380/415</td><td>~ 50kA</td></tr> <tr><td>440/480</td><td>~ 50kA</td></tr> <tr><td>480/500</td><td>~ 40kA</td></tr> <tr><td>660/690</td><td>~ 35kA</td></tr> </table> <p>Icu = 100% Icu Icw = 25kA/1s</p> <p>IEC 60947-2 Cat.B LS Industrial Systems MADE IN KOREA</p>	Ue(V)	Icu(kA)	220/240	~ 55kA	380/415	~ 50kA	440/480	~ 50kA	480/500	~ 40kA	660/690	~ 35kA	<p><b>TS 1000N</b> 830A UI 1000V Ulmp 8kV</p> <table border="1"> <tr><th>Ue(V)</th><th>Icu(kA)</th></tr> <tr><td>220/240</td><td>~ 55kA</td></tr> <tr><td>380/415</td><td>~ 50kA</td></tr> <tr><td>440/480</td><td>~ 50kA</td></tr> <tr><td>480/500</td><td>~ 40kA</td></tr> <tr><td>660/690</td><td>~ 35kA</td></tr> </table> <p>Icu = 100% Icu Icw = 25kA/1s</p> <p>IEC 60947-2 Cat.B LS Industrial Systems MADE IN KOREA</p>	Ue(V)	Icu(kA)	220/240	~ 55kA	380/415	~ 50kA	440/480	~ 50kA	480/500	~ 40kA	660/690	~ 35kA	<p><b>TS 1000N</b> 630A UI 1000V Ulmp 8kV</p> <table border="1"> <tr><th>Ue(V)</th><th>Icu(kA)</th></tr> <tr><td>220/240</td><td>~ 55kA</td></tr> <tr><td>380/415</td><td>~ 50kA</td></tr> <tr><td>440/480</td><td>~ 50kA</td></tr> <tr><td>480/500</td><td>~ 40kA</td></tr> <tr><td>660/690</td><td>~ 35kA</td></tr> </table> <p>Icu = 100% Icu Icw = 25kA/1s</p> <p>IEC 60947-2 Cat.B LS Industrial Systems MADE IN KOREA</p>	Ue(V)	Icu(kA)	220/240	~ 55kA	380/415	~ 50kA	440/480	~ 50kA	480/500	~ 40kA	660/690	~ 35kA
Ue(V)	Icu(kA)																																																															
220/240	~ 55kA																																																															
380/415	~ 55kA																																																															
440/480	~ 55kA																																																															
480/500	~ 40kA																																																															
660/690	~ 35kA																																																															
Ue(V)	Icu(kA)																																																															
220/240	~ 65kA																																																															
380/415	~ 50kA																																																															
440/480	~ 50kA																																																															
480/500	~ 40kA																																																															
660/690	~ 35kA																																																															
Ue(V)	Icu(kA)																																																															
220/240	~ 55kA																																																															
380/415	~ 50kA																																																															
440/480	~ 50kA																																																															
480/500	~ 40kA																																																															
660/690	~ 35kA																																																															
Ue(V)	Icu(kA)																																																															
220/240	~ 55kA																																																															
380/415	~ 50kA																																																															
440/480	~ 50kA																																																															
480/500	~ 40kA																																																															
660/690	~ 35kA																																																															
Ue(V)	Icu(kA)																																																															
220/240	~ 55kA																																																															
380/415	~ 50kA																																																															
440/480	~ 50kA																																																															
480/500	~ 40kA																																																															
660/690	~ 35kA																																																															
<p><b>TS 1600H</b> 1630A UI 1000V Ulmp 8kV</p> <table border="1"> <tr><th>Ue(V)</th><th>Icu(kA)</th></tr> <tr><td>220/240</td><td>~ 75kA</td></tr> <tr><td>380/415</td><td>~ 70kA</td></tr> <tr><td>440/480</td><td>~ 65kA</td></tr> <tr><td>480/500</td><td>~ 50kA</td></tr> <tr><td>660/690</td><td>~ 45kA</td></tr> </table> <p>Icu = 75% Icu Icw = 25kA/1s</p> <p>IEC 60947-2 Cat.B LS Industrial Systems MADE IN KOREA</p>	Ue(V)	Icu(kA)	220/240	~ 75kA	380/415	~ 70kA	440/480	~ 65kA	480/500	~ 50kA	660/690	~ 45kA	<p><b>TS 1250H</b> 1250A UI 1000V Ulmp 8kV</p> <table border="1"> <tr><th>Ue(V)</th><th>Icu(kA)</th></tr> <tr><td>220/240</td><td>~ 75kA</td></tr> <tr><td>380/415</td><td>~ 70kA</td></tr> <tr><td>440/480</td><td>~ 65kA</td></tr> <tr><td>480/500</td><td>~ 50kA</td></tr> <tr><td>660/690</td><td>~ 45kA</td></tr> </table> <p>Icu = 75% Icu Icw = 25kA/1s</p> <p>IEC 60947-2 Cat.B LS Industrial Systems MADE IN KOREA</p>	Ue(V)	Icu(kA)	220/240	~ 75kA	380/415	~ 70kA	440/480	~ 65kA	480/500	~ 50kA	660/690	~ 45kA	<p><b>TS 1000H</b> 1000A UI 1000V Ulmp 8kV</p> <table border="1"> <tr><th>Ue(V)</th><th>Icu(kA)</th></tr> <tr><td>220/240</td><td>~ 75kA</td></tr> <tr><td>380/415</td><td>~ 70kA</td></tr> <tr><td>440/480</td><td>~ 65kA</td></tr> <tr><td>480/500</td><td>~ 50kA</td></tr> <tr><td>660/690</td><td>~ 45kA</td></tr> </table> <p>Icu = 75% Icu Icw = 25kA/1s</p> <p>IEC 60947-2 Cat.B LS Industrial Systems MADE IN KOREA</p>	Ue(V)	Icu(kA)	220/240	~ 75kA	380/415	~ 70kA	440/480	~ 65kA	480/500	~ 50kA	660/690	~ 45kA	<p><b>TS 1000H</b> 830A UI 1000V Ulmp 8kV</p> <table border="1"> <tr><th>Ue(V)</th><th>Icu(kA)</th></tr> <tr><td>220/240</td><td>~ 75kA</td></tr> <tr><td>380/415</td><td>~ 70kA</td></tr> <tr><td>440/480</td><td>~ 65kA</td></tr> <tr><td>480/500</td><td>~ 50kA</td></tr> <tr><td>660/690</td><td>~ 45kA</td></tr> </table> <p>Icu = 75% Icu Icw = 25kA/1s</p> <p>IEC 60947-2 Cat.B LS Industrial Systems MADE IN KOREA</p>	Ue(V)	Icu(kA)	220/240	~ 75kA	380/415	~ 70kA	440/480	~ 65kA	480/500	~ 50kA	660/690	~ 45kA	<p><b>TS 1000H</b> 630A UI 1000V Ulmp 8kV</p> <table border="1"> <tr><th>Ue(V)</th><th>Icu(kA)</th></tr> <tr><td>220/240</td><td>~ 75kA</td></tr> <tr><td>380/415</td><td>~ 70kA</td></tr> <tr><td>440/480</td><td>~ 65kA</td></tr> <tr><td>480/500</td><td>~ 50kA</td></tr> <tr><td>660/690</td><td>~ 45kA</td></tr> </table> <p>Icu = 75% Icu Icw = 25kA/1s</p> <p>IEC 60947-2 Cat.B LS Industrial Systems MADE IN KOREA</p>	Ue(V)	Icu(kA)	220/240	~ 75kA	380/415	~ 70kA	440/480	~ 65kA	480/500	~ 50kA	660/690	~ 45kA
Ue(V)	Icu(kA)																																																															
220/240	~ 75kA																																																															
380/415	~ 70kA																																																															
440/480	~ 65kA																																																															
480/500	~ 50kA																																																															
660/690	~ 45kA																																																															
Ue(V)	Icu(kA)																																																															
220/240	~ 75kA																																																															
380/415	~ 70kA																																																															
440/480	~ 65kA																																																															
480/500	~ 50kA																																																															
660/690	~ 45kA																																																															
Ue(V)	Icu(kA)																																																															
220/240	~ 75kA																																																															
380/415	~ 70kA																																																															
440/480	~ 65kA																																																															
480/500	~ 50kA																																																															
660/690	~ 45kA																																																															
Ue(V)	Icu(kA)																																																															
220/240	~ 75kA																																																															
380/415	~ 70kA																																																															
440/480	~ 65kA																																																															
480/500	~ 50kA																																																															
660/690	~ 45kA																																																															
Ue(V)	Icu(kA)																																																															
220/240	~ 75kA																																																															
380/415	~ 70kA																																																															
440/480	~ 65kA																																																															
480/500	~ 50kA																																																															
660/690	~ 45kA																																																															

TRF No. IEC60947\_2F

ВЯРНО С  
ОРИГИНАЛА



694

Test item particulars: test item vs. test requirements	
<b>3. Classification</b>	
3.1. Utilization category: (A or B).....	: B
3.2. Interruption medium: (air, vacuum, gas Break) .....	: Air
3.3. Design: (open construction, moulded case) .....	: Moulded case
3.4. Method of controlling the operation mechanism: (dependent manual, independent manual, dependent power, independent power).....	: Independent manual
3.5. Suitability for insulation: (suitable, not -suitable) .....	: Suitable
3.6. Provision for maintenance: (maintainable, non maintainable) .....	: Maintainable
3.7. Method of installation: (fixed, plug in, withdrawable:	: Fixed
3.8. Degree of protection: (IP code).....	: IP30
4.7. Type of release (thermo-magnetic / electronic).....	: Electronic
4.8. Integral fuses (integrally fused circuit-breakers) Type and characteristics of SCPD.....	: N/A
7.3 Electromagnetic compatibility (EMC) Environment A or B .....	: A
Circuit-breaker for use on phase-earthed systems .....	: N/A
Circuit-breaker for use in IT systems .....	: P
Rated and limiting values, main circuit .....	
- rated operational voltage: $U_e$ (V) .....	: 220/240, 380/415, 440/460, 480/500, 660/690 V
- rated insulation voltage: $U_i$ (V) .....	: 1000 V
- rated impulse withstand voltage: $U_{imp}$ (kV) .....	: 8 kV
- rated operational current: $I_e$ (A) .....	: 630, 800, 1000, 1250, 1600 A
- kind of current.....	: AC
- conventional free air thermal current: $I_{th}$ (A) .....	: 1600 A
- conventional enclosed thermal current: $I_{the}$ (A) .....	: N/A
- current rating for four-pole circuit-breakers: (A) .....	: N/A
- number of poles .....	: 3/4P
- rated frequency: (Hz).....	: 50/60 Hz
- integral fuses (rated values).....	: N/A
<b>Rated duty :</b>	
- eight-hour duty.....	: N/A
- uninterrupted duty: $I_u$ (A).....	: 1600 A

TRF No. IEC60947\_2F



<b>Short-circuit characteristic :</b>	
rated short-time making capacity: $I_{cm}$ (kA) .....	165 kA
rated ultimate short-circuit breaking capacity: $I_{cu}$ (kA) .....	TS1000H, TS1250H, TS1600H
	75 kA / 220&240 V, 70 kA / 380&415 V,
	65 kA / 440&460 V, 50 kA / 480&500 V ,
	45 kA / 660&690 V
	TS1000N, TS1250N, TS1600N
	55 kA/220&240 V, 50 kA/380&415 V
	50 kA/440&460 V, 40 kA/480&500 V
	35 kA/660&690 V
rated service short-circuit breaking capacity: $I_{cs}$ (kA) .....	$I_{cs} = 75\% I_{cu}$ (H-type), $I_{cs} = 100\% I_{cu}$ (N-type)
rated short-time withstand current: $I_{cw}$ (kA/s) .....	25 kA 1s
<b>Control circuits :</b>	
<b>Electrical control circuits :</b>	
- kind of current: (AC, DC).....	N/A
- rated frequency: (Hz).....	N/A
- rated control circuit voltage: $U_c$ ( nature, frequency, V) ...	N/A
- rated control supply voltage: $U_s$ (nature, frequency V) ...	N/A
Air supply control circuits: (pneumatic or electro-pneumatic) : N/A	
- rated pressure and its limit.....	N/A
- volumes of air, at atmospheric pressure, required for each closing and each opening operation .....	N/A
<b>Auxiliary circuits :</b>	
Rated and limiting values, auxiliary circuits..... : N/A	
- rated operational voltage $U_e$ (V) .....	N/A
- rated insulation voltage: $U_i$ (V) .....	N/A
- rated operational current: $I_e$ (A) .....	N/A
- kind of current.....	N/A
- rated frequency: (Hz).....	N/A
- number of circuits.....	N/A
- number and kind of contact elements .....	N/A
- rated uninterrupted current: $I_u$ (A).....	N/A
- utilization category: (AC, DC, current and voltage).....	N/A
<b>Short-circuit characteristic :</b>	
- Rated conditional short-circuit current (kA) .....	N/A
- kind of protective device.....	N/A

TRF No. IEC60947\_2F

ВЕРНО С  
ОПРЕДЕЛЕНИЯ



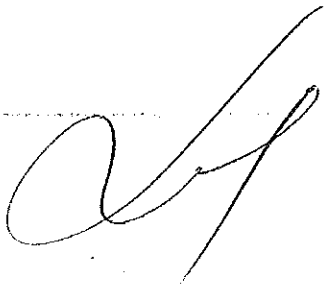

Releases	
1) shunt release .....	N/A
2) Over-current release .....	
a) instantaneous .....	P
b) definite time delay .....	P
c) inverse time delay .....	P
- independent of previous load .....	P
- dependent on previous load; (for example thermal type release) .....	N/A
3) Undervoltage release (for opening) .....	N/A
4) Other releases .....	N/A
Characteristics :	
1) Shunt release and undervoltage release (for opening) ... :	
- rated control circuit voltage: $U_c$ ( nature, frequency, V) ... :	N/A
- kind of current .....	N/A
- rated frequency: (if AC) .....	N/A
2) Over-current release .....	
- rated current .....	630, 800, 1000, 1250, 1600 A
- kind of current .....	AC
- rated frequency: (if AC) .....	50/60 Hz
- current setting (or range of settings) .....	0,4~1,0 In
- time settings (or range of settings) .....	50, 100, 200, 300, 400 ms @ 1,5 ~ 10 Ir

TRF No. IEC60947\_2F



ВАРНО С  
 ОБЩИНАТА  
 СОФИЯ  
 15.06.2016

6.99

Classification of installation and use .....	Moulded case circuit breaker
Supply Connection.....	3 phase + N
.....	
.....	
<b>Possible test case verdicts:</b>	
- test case does not apply to the test object.....	N/A
- test object does meet the requirement .....	P (Pass)
- test object does not meet the requirement .....	F (Fail)
<b>Testing</b> .....	
Date of receipt of test item .....	July 10, 2010
Date (s) of performance of tests .....	July 12, 2010~ August 30,2010
<b>General remarks:</b>	
The test results presented in this report relate only to the object tested. This report shall not be reproduced, except in full, without the written approval of the Issuing testing laboratory. "(See Enclosure #)" refers to additional information appended to the report. "(See appended table)" refers to a table appended to the report. Throughout this report a comma (point) is used as the decimal separator.	

TRF No. IEC60947\_2F





698

**General product information:**

Subject	Molded-case circuit-breaker	
Manufacturer	LS Industrial Systems Co., Ltd.	
Type designation	TS1000N, TS1250N, TS1600N TS1000H, TS1250H, TS1600H	
Frame size	1000, 1250, 1600 AF	
Number of poles	3/4P	
Rated frequency	50/60 Hz	
Rated operational voltage	AC 220/240, 380/415, 440/460, 480/500, 660/690 V	
Rated insulation voltage	AC 1000 V	
Rated impulse withstand voltage	8 kV	
Suitability for isolation	Yes	
Rated current	630, 800, 1000, 1250, 1600A	
Rated ultimate short-circuit breaking capacity	H	N
	75 kA/220&240 V	55 kA/220&240 V
	70 kA/380&415 V	50 kA/380&415 V
	65 kA/440&460 V	50 kA/440&460 V
	50 kA/480&500 V	40 kA/480&500 V
Rated service short-circuit breaking capacity	Ics = 75% Icu	Ics = 100% Icu
Rated short-time withstand current	25 kA 1sec	
Utilization category	B	
Type of tripping device	Electronics Trip Device	
Short time releases:		
Current setting (or range of settings)	1.5-2-3-4-5-6-8-10 Ir (adjustable-8 settings)	
Time setting (or range of setting)	I <sub>t</sub> off : 0.05-0.1-0.2-0.3-0.4 (adjustable-5 settings) I <sub>t</sub> on : 0.1-0.2-0.3-0.4 (adjustable-4 settings)	
Instantaneous releases:	Electronics Trip Device	
Current setting (or range of settings)	2-3-4-6-8-10-12-15 In (adjustable-8 settings)	
Time setting (or range of setting)	Fixed ( <50ms )	
Long time release:		
Current setting (or range of settings)	0.4~1.0 In (adjustable-54 settings)	
Time setting (or range of setting)	0.5-1-2-4-8-12-16-20 (adjustable-8 settings)	
Type of neutral	Over-current release	
Release dependent on ambient air temperature	No	
Reference temperature	40 °C	
Dimension of specimen	327(H)X210(W)X152.5(D)[3P] / 327(H)X280(W)X152.5(D)[4P]	
Dimension of metal screen	644(H)X357(W)X152.5(D)[3P] / 644(H)X427(W)X152.5(D)[4P]	

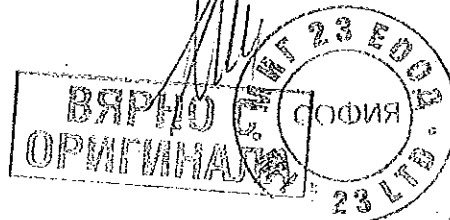
TRF No. IEC60947\_2F

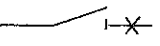

IEC 60947-2			
Clause	Requirement + Test	Result - Remark	Verdict
5.2	MARKING		
a)	The following data shall be marked on the circuit-breaker itself or on a name plate or nameplates attached to the circuit-breaker, and located in a place such that they are visible and legible when the circuit-breaker is installed.		
	- rated current:	630, 800, 1000, 1250, 1600 A	P
	- suitability for isolation, if applicable, with the symbol 	Compliance	P
	- indication of the open and closed position: with O and I respectively, if symbols are used	Compliance	P
b)	Marking on equipment not needed to be visible after mounting:		
	- manufacturer's name or trademark	LS	P
	- type designation or serial number	TS1000N, TS1250N, TS1600NTS1000H, TS1250H, TS1600H	P
	- IEC 60947-2 if the manufacturer claims compliance with this standard.	IEC 60947-2	P
	- utilization category	B	P
	- rated operational voltage(s) Ue	220/240, 380/415, 440/460, 480/500, 660/690 V	P
	- Circuit-breaker for use in IT systems: Circuit-breaker for which all values of rated voltage have not been tested according to annex H or are not covered by such testing, shall be identified by the symbol  which shall be marked on the circuit-breaker immediately following these values of rated voltage	Compliance	P
	- value (or range) of the rated frequency and/or the indication DC (or symbol)	50/60 Hz	P
	- rated ultimate short-circuit breaking capacity. Icu	TS1000H, TS1250H, TS1600H  75kA/220&240V, 70kA /380& 415V, 65kA/440&460V, 50kA/480&500V, 45kA / 660&690V  TS1000N, TS1250N, TS1600N  55kA/220&240V, 50 kA/380& 415V, 50kA/440&460V, 40 kA/480&500V, 35kA/660&690V	P

IEC 60947-2			
Clause	Requirement + Test	Result - Remark	Verdict
	- rated service short-circuit breaking capacity. Ics	Ics = 75% Icu (H-type), Ics = 100% Icu (N-type)	P
	- rated short-time withstand current, (Icw) and associated short-time delay, for utilization category B	25 kA 1 s	P
	- line and load terminals, unless their connection is immaterial	Immaterial	P
	- neutral pole terminals, if applicable, by the letter N	-	N/A
	- protective earth terminal, where applicable, by the symbol acc. 7.1.9.3 of part 1	-	N/A
	- ref. temperature for non-compensated thermal releases, if different from 30°C	-	N/A
c)	Marked on the circuit-breaker as specified in item b), or shall be made available in the manufacturer's published information:		
	- rated short-circuit making capacity (Icm) (if higher than specified in 4.3.5.1)	165 kA	P
	- rated insulation voltage. (Ui) if higher than the maximum rated operational voltage)	1000 V	P
	- rated impulse withstand voltage (Uimp), when declared,	8 kV	P
	- pollution degree if other than 3	3	P
	- conventional enclosed thermal current (Ithe) if different from the rated current:	-	N/A
	- IP Code, where applicable:	IP30	P
	- minimum enclosure size and ventilation data (if any) to which marked ratings apply:	-	N/A
	- details of minimum distance between circuit-breaker and earthed metal parts for circuit-breaker intended for use without enclosure:	Compliance	P
	- r.m.s sensing if applicable, according to F.4.1.1	-	N/A
	- suitability for environment A or B	A	P
d)	The following data concerning the opening and closing devices of the circuit-breaker shall be placed either on their own nameplates or on the nameplate of the circuit-breaker:		
	- rated control circuit voltage of the closing device, and rated frequency for AC:	-	N/A

IEC 60947-2			
Clause	Requirement + Test	Result - Remark	Verdict
	- rated control circuit voltage of the shunt release and/or of the under-voltage release, and rated frequency:	-	N/A
	- rated current of indirect over-current releases:	-	N/A
	- number and type of auxiliary contacts and kind of current, rated frequency (if AC) and rated voltages of the auxiliary switches, if different from those of the main circuit.	-	N/A
e)	Terminal shall be clearly and permanently identified in acc. with IEC 60445 and annex L:		
	- line terminal	-	N/A
	- load terminal	-	N/A
	- neutral pole terminal "N"	N	P
	- protective earth terminal 	-	N/A
	- terminal of coils (A/B)	-	N/A
	- terminal of shunt release ( B )	-	N/A
	- terminals of under-voltage release (D)	-	N/A
	- terminals of interlocking electromagnets (E)	-	N/A
	- terminals of indicated light devices (X)	-	N/A
	- terminals of contact elements for switching devices (no)	-	N/A

7.1	CONSTRUCTION		
7.1.1	Withdrawable circuit-breaker	-	N/A
	In the disconnected position (main- and auxiliary circuits)		
	Isolating distances for circuit-breaker suitable for isolating warranted:	-	N/A
	Mechanism fitted with a reliable indicating device with indicates the position of the isolating contacts.	-	N/A
	Mechanism fitted with interlocks which only permit the isolating contacts to be separate or re-closed when main contacts are open.	-	N/A
	Mechanism fitted with interlock, which only permit the main contacts to be closed when the isolating contacts are fully closed.	-	N/A

TRF No. IEC60947\_2F

ВЯРНО С  
ОРИГИНАЛА

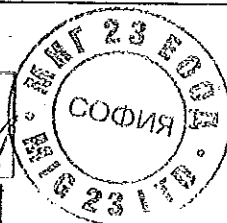

202

IEC 60947-2			
Clause	Requirement + Test	Result - Remark	Verdict
	Mechanism fitted with interlock, which only permit the main contacts to be closed when in disconnected position.	-	N/A
	The isolating distances between the isolating contacts cannot be inadvertently reduced.	-	N/A
7.1.2.1 part 1	Resistance to abnormal heat and fire	-	N/A
7.1.3 part 1	Current-carrying parts and their connection	Compliance	P
7.1.4	Clearances and creepage distances:		
	For circuit-breakers for which the manufacturer has declared a value of rated impulse withstand voltage. (Uimp.)		
	Clearances distances:		
	- Uimp is given as:	8 kV	
	- max. value of rated operational voltage to earth.....	399 V	
	- nominal voltage of supply system:	690 V	
	- overvoltage category:	IV	
	- pollution degree:	3	
	- field-in or homogeneous:	Inhomogeneous	
	- minimum clearances (mm):	8 mm	
	- measured clearances (mm):	31,3 mm	P
	Creepage distances:		
	- rated insulation voltage Ui (V)	1000V	
	- pollution degree	3	
	- comparative tracking index (V)	175 ≤ CTI < 400	
	- material group	IIIa	
	- minimum creepage distances (mm)	16 mm	
	- measured creepage distances (mm)	32,9 mm	P
7.1.5 part 1	Actuator		
7.1.5.1 part 1	Insulation		
	The actuator of the equipment shall be insulated from the live parts for the rated insulation voltage and, if applicable, the rated impulse withstand voltage	Compliance	P



*[Handwritten signature]*  
203

IEC 60947-2			
Clause	Requirement + Test	Result - Remark	Verdict
	If it is made of metal, it shall be capable of being satisfactorily connected to a protective conductor unless it is provided with additional reliable insulation	-	N/A
	If it is made of or covered by insulating material, any internal metal part, which might become accessible in the event of insulation failure, shall also be insulated from live parts for the rated insulation voltage	Compliance	P
7.1.5.2	Direction of movement		
	The direction of operation for actuators of devices shall normally conform to IEC 60447.	Compliance	P
	Where devices cannot conform to these requirements, e.g. due to special applications or alternative mounting positions, they shall be clearly marked such that there is no doubt as to the "I" and "O" positions and the direction of operation	Compliance	P
7.1.6 part 1	Indication of contact position		
7.1.6.1 part 1	Indicating means		
	When an equipment is provided with means for indicating the closed and open positions, these positions shall be unambiguous and clearly indicated	Compliance	P
	This is done by means of a position indicating device (see 2.3.18)	Compliance	P
	If symbols are used, they shall indicate the closed and open position respectively, in accordance with IEC 60417-2:		
	- 60417-2-IEC-5007    I    On (power)	Compliance	P
	- 60417-2-IEC-5007    O    Off (power)	Compliance	P
	For equipment operated by means of two push-buttons, only the push-button designated for the opening operation shall be red or marked with the symbol "O"	-	N/A
	Red colour shall not be used for any other push-button	-	N/A
	The colours of other push-buttons, illuminated push-buttons and indicator lights shall be in accordance with IEC 60073	-	N/A
7.1.6.2 part 1	Indication by the actuator		



IEC 60947-2			
Clause	Requirement + Test	Result - Remark	Verdict
	When the actuator is used to indicate the position of the contacts, it shall automatically take up or stay, when released, in the position corresponding to that of the moving contacts; in this case, the actuator shall have two distinct rest positions corresponding to those of the moving contacts, but for automatic opening a third distinct position of the actuator may be provided	On position Off position Trip position	P
7.1.7	Additional safety requirements for equipment suitable for isolation		
7.1.7.1	Additional constructional requirements for equipment suitable for isolation (Ue > 50 V):		
	Equipment suitable for isolation shall provide in the open position an isolation distance in acc. with the requirements necessary to satisfy the isolating function. Indication of the main contacts shall be provide by one or more of the following means:		
	- the position of the actuator	Compliance	P
	- a separate mechanical indicator	-	N/A
	- visibility of the moving contacts	-	N/A
	When means are provided or to lock the equipment in the open position, locking only be possible when contacts are in the open position	-	N/A
	Actuator front-plate fitted to the equipment in a manner which ensures correct contact position indication and locking	-	N/A
	The indicated open position is the only position in which the specified isolation distances between the contacts is ensured.	Compliance	P
	- minimum clearances across open contacts (see Table XIII, Part 1) (mm) :	8 mm	
	- measured clearances (mm) :	31,3 mm	P
	- test Uimp across gap (kV) :	12,3 kV	P
7.1.7.2	Supplementary requirements for equipment with provision for electrical interlocking with contactors or circuit-breakers:		
	auxiliary switch shall be rated according to IEC 60 947-5-1	-	N/A
	If equipment suitable for isolation is provided with an auxiliary switch for the purpose of electrical interlocking with contactor (s) or circuit breaker(s) and intended to be used in motor circuits, the following requirements shall apply unless the equipment is rated for AC-23 utilization category	-	N/A

IEC 60947-2			
Clause	Requirement + Test	Result - Remark	Verdict
	The time interval between the opening of the contacts of the auxiliary switch and the contacts of the main poles shall be sufficient to ensure that the associated contactor or circuit-breaker interrupts the current before the main poles of the equipment open	-	N/A
	Unless otherwise stated in the manufacturer's technical literature, the time interval shall be not less than 20 ms when the equipment is operated according to the manufacturer instructions	-	N/A
	Compliance shall be verified by measuring the time interval between the instant of opening of the auxiliary switch and the instant of opening of the main poles under no-load conditions when the equipment is operated according to the manufacturer's instructions	-	N/A
	During the closing operation the contacts of the auxiliary switch shall close after or simultaneously with the contacts of the main poles	-	N/A
	A suitable opening time interval may also be provided by an intermediate position (between the ON and OFF position) at which the interlocking contact(s) is (are) open and the main poles remain closed	-	N/A
7.1.7.3	Supplementary requirements for equipment provided with means for padlocking the open position:		
	the locking means shall be designed in such a way that it cannot be removed with the appropriate padlock(s) installed	-	N/A
	Alternatively, the design may provide padlockable means to prevent access to the actuator	-	N/A
	test force F applied to the actuator in an attempt to operate to the closed position (N) :	-	N/A
	rated impulse withstand voltage (kV) :	-	N/A
	test U <sub>imp</sub> on open main contacts at the test force	-	N/A
7.1.8	Terminals		
7.1.8.1	All parts of terminals which maintain contact and carry current shall be of metal having adequate mechanical strength	Compliance	P

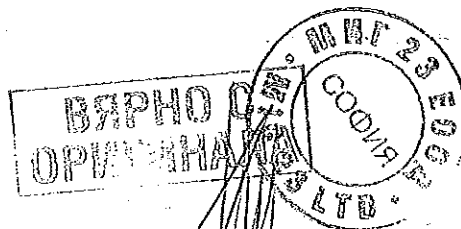



IEC 60947-2			
Clause	Requirement + Test	Result - Remark	Verdict
	Terminal connections shall be such that necessary contact pressure is maintained	Compliance	P
	Terminals shall be so constructed that the conductor is clamped between suitable surfaces without damage to the conductor and terminal	Compliance	P
	Terminal shall not allow the conductor to be displaced or to be displaced themselves in a manner detrimental to the operator of equipment and the insulation voltage shall not be reduced below the rated value	Compliance	P
7.1.8.2	Connection capacity		
	type of conductors :	Flexible and stranded type/ Copper bars	P
	minimum cross-sectional area of conductor (mm <sup>2</sup> ) :	400 mm <sup>2</sup> or 2x(40 mm x 5 mm)	P
	maximum cross-sectional area of conductor (mm <sup>2</sup> ) :	1000 mm <sup>2</sup> or 2x(50 mmx10 mm)	P
	number of conductors simultaneously connectable to the terminal :	2	P
7.1.8.3	Connection		
	terminals for connection to external conductors shall be readily accessible during installation	Compliance	P
	clamping screws and nuts shall not serve to fix any other component	Compliance	P
7.1.8.4	Terminal identification and marking		
	terminal intended exclusively for the neutral conductor	N	P
	protective earth terminal	-	N/A
	other terminals	-	N/A
7.1.9 part 1	Additional requirements for equipment provided with a neutral pole		
	When equipment is provided with a pole intended only for connecting the neutral, this pole shall be clearly identified to that effect by the letter N (see 7.1.7.4.).	-	N/A
	A switched neutral pole shall break not before and shall make not after the other poles	-	N/A

TRF No. IEC60947\_2F



707

IEC 60947-2			
Clause	Requirement + Test	Result - Remark	Verdict
	For equipment having a value of conventional thermal current (free air or enclosed, see 4.3.2.1 and 4.3.2.2) not exceeding 63 A, this value shall be identical for all poles	-	N/A
	For higher conventional thermal current values, the neutral pole may have a value of conventional thermal current different from that of the other poles, but not less than half that value or 63 A, whichever is the higher	-	N/A
	if a pole with an appropriate making and breaking capacity is used as a neutral pole, then all poles, incl. the neutral pole, shall operate substantially together.	-	N/A
7.1.10	Provisions for protective earthing		
7.1.10.1	The exposed conductive parts (e.g. chassis, framework and fixed parts of metal enclosures) other than those which cannot constitute a danger shall be electrically interconnected and connected to a protective earth terminal for connection to an earth electrode or to an external protective conductor	-	N/A
part 1	This requirement can be met by the normal structural parts providing adequate electrical continuity and applies whether the equipment is used on its own or incorporated in an assembly	-	N/A
	Exposed conductive parts are considered not to constitute a danger if they cannot be touched on large areas or grasped with the hand or if they are of small size (approximately 50 mm x 50 mm) or are so located as to exclude any contact with live parts	-	N/A
7.1.10.2 part 1	Protective earth terminal		
	The protective earth terminal shall be readily accessible and so placed that the connection of the equipment to the earth electrode or to the protective conductor is maintained when the cover or any other removable part is removed	-	N/A
	The protective earth terminal shall be suitably protected against corrosion	-	N/A
	In the case of equipment with conductive structures, enclosures, etc., means shall be provided, if necessary, to ensure electrical continuity between the exposed conductive parts the equipment and the metal sheathing of connecting conductors	-	N/A

IEC 60947-2			
Clause	Requirement + Test	Result - Remark	Verdict
	The protective earth terminal shall have no other function, except when it is intended to be connected to a PEN conductor (see 2.1.1.5 – Note). In this case, it shall also have the function of a neutral terminal in addition to meeting the requirements applicable to the protective earth terminal	- 	N/A
7.1.10.3	Protective earth terminal marking and identification	-	
	The protective earth terminal shall be clearly and permanently identified by its marking	-	N/A
	The identification shall be achieved by colour (green-yellow mark) or by the notation PE, or PEN, as applicable, in accordance with IEC 60445, subclause 5.3, or, in the case of PEN, by a graphical symbol for use on equipment	-	N/A
	Graphical symbol to be used: 60417-2-IEC-5019  Protective earth (ground) in accordance with IEC 60417-2	-	N/A
7.1.11	Enclosure for equipment		
7.1.11.1	Design		
	The enclosure, when it is opened: all parts requiring access for installation and maintenance are readily accessible	-	N/A
	Sufficient space shall be provided inside the enclosure	-	N/A
	The fixed parts of a metal enclosure shall be electrically connected to the other exposed conductive parts of the equipment and connected to a terminal which enables them to be earthed or connected to a protective conductor	-	N/A
	Under no circumstances shall a removable metal part of the enclosure be insulated from the part carrying the earth terminal when the removable part is in place	-	N/A
	The removable parts of the enclosure shall be firmly secured to the fixed parts by a device such that they cannot be accidentally loosened or detached owing to the effects of operation of the equipment or vibrations	-	N/A

IEC 60947-2			
Clause	Requirement + Test	Result - Remark	Verdict
	When an enclosure is so designed as to allow the covers to be opened without the use of tools, means shall be provided to prevent loss of the fastening devices	-	N/A
	If the enclosure is used for mounting push-buttons, it shall not be possible to remove the buttons from the outside of the enclosure	-	N/A
7.1.11.2	Insulation		
	If, in order to prevent accidental contact between a metallic enclosure and live parts, the enclosure is partly or completely lined with insulating material, then this lining shall be securely fixed to the enclosure	-	N/A
7.1.12	Degree of protection of enclosed equipment		
	Degree of protection.	IP30	
	Test for first characteristic.	IP3X	
	Test for first numeral .....	1 2 3:Compliance 4 5 6	P
	Test for second characteristic	IPX0	
	Test for second numeral .....	1 2 3 4 5 6 7 8	P
7.1.13 part 1	Conduit pull-out, torque and bending with metallic conduits		
	Polymeric enclosures of equipment, whether integral or not, provided with threaded conduit entries, intended for the connection of extra heavy duty, rigid threaded metal conduits complying with IEC 60981, shall withstand the stresses occurring during its installation such as pull-out, torque, bending	-	N/A

TRF-No. IEC60947\_2F

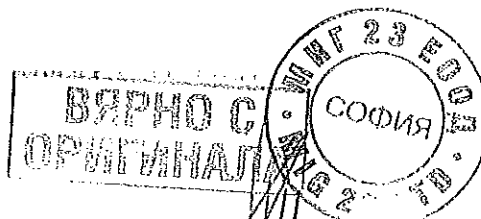

100

IEC 60947-2			
Clause	Requirement + Test	Result - Remark	Verdict
7.2	Performance requirements		
7.2.1	Operating condition		
7.2.1.1	Closing		
	For a circuit-breaker to be closed safely on to the making current corresponding to its rated short-circuit making capacity, it is essential that it should be operated with the same speed and the same firmness as during the type test for proving the short-circuit making capacity	Compliance	P
7.2.1.1.1	Dependent manual closing		
	For a circuit-breaker having a dependent manual closing mechanism, it is not possible to assign a short-circuit making capacity rating irrespective of the conditions of mechanical operation	-	N/A
	Such a circuit-breaker should not be used in circuits having a prospective peak making current exceeding 10 kA	-	N/A
	However, this does not apply in the case of a circuit-breaker having a dependent manual closing mechanism and incorporating an integral fast-acting opening release which causes the circuit-breaker to break safely, irrespective of the speed and firmness with which it is closed on to prospective peak currents exceeding 10 kA; in this case, a rated short-circuit making capacity can be assigned	-	N/A
7.2.1.1.2	Independent manual closing		
	A circuit-breaker having an independent manual closing mechanism can be assigned a short-circuit making capacity rating irrespective of the conditions of mechanical operation	Compliance	P
7.2.1.1.3	Dependent power closing		
	At 110% of the rated control supply voltage, the closing operation performed on no-load shall not cause any damage to the circuit-breaker.	-	N/A
	At 85% of the rated control supply voltage, the closing operation shall be performed when the current established by the circuit-breaker is equal to its rated making capacity within the limits allowed by the operation of its relays or releases and, if a maximum time is stated for the closing operation, in a time not exceeding this maximum time limit.	-	N/A

ВАРНО С  
ОРИГИНАЛА

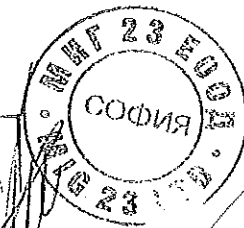

*[Handwritten signature]*  
311

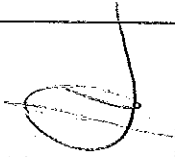
IEC 60947-2			
Clause	Requirement + Test	Result - Remark	Verdict
7.2.1.1.4	Independent power closing		
	A circuit-breaker having an independent power closing operation can be assigned a rated short-circuit making capacity irrespective of the conditions of power closing	- 	N/A
	Means for charging the operating mechanism, as well as the closing control components, shall be capable of operating in accordance with the manufacturer's specification	-	N/A
7.2.1.1.5	Stored energy closing		
	Capable ensuring closing of the circuit-breaker in any condition between no-load and its rated making capacity	-	N/A
	- when the stored energy is retained within the circuit-breaker, a device is provided which indicates when the storing mechanism is fully charged.	-	N/A
	- means for charging the operating mechanism and closing control components operates when auxiliary supply voltage is between 85% and 110% of the rated control supply voltage.	-	N/A
	- not possible for the moving contacts to move from the open position, unless the charge is sufficient for satisfactory completion of the closing operation.	-	N/A
	- by manually operated circuit-breaker is the direction of operation indicated. (not for circuit-breaker with an independent manual closing operation.)	-	N/A
	- For trip free circuit-breaker it shall not be possible to maintain the contacts in the touching or closed position when the release is in the position to trip the circuit-breaker.	-	N/A

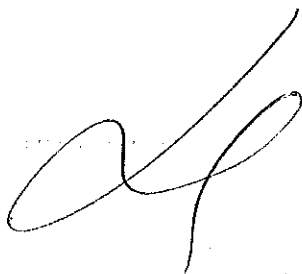

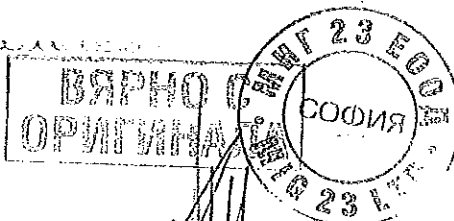



IEC 60947-2			
Clause	Requirement + Test	Result - Remark	Verdict
7.2.1.2	Opening		
7.2.1.2.1	Circuit-breakers which open automatically shall be trip-free and, unless otherwise agreed between manufacturer and user, shall have their energy for the tripping operation stored prior to the completion of the closing operation		
7.2.1.2.2	Opening by undervoltage releases		
7.2.1.3. a part 1	Operating voltage		
	An under-voltage relay or release, when associated with a switching device, shall operate to open the equipment even on a slowly falling voltage within the range between 70% and 35% of its rated voltage	-	N/A
	An under-voltage relay or release shall prevent the closing of the equipment when the supply voltage is below 35% of the rated voltage of the relay or release; it shall permit closing of the equipment at supply voltages equal to or above 85% of its rated value	-	N/A
	Unless otherwise stated in the relevant product standard, the upper limit of the supply voltage shall be 110% of its rated value	-	N/A
7.2.1.3. b part 1	Operating time		
	For a time-delay under-voltage relay or release, the time-lag shall be measured from the instant when the voltage reaches the operating value until the instant when the relay or release actuates the tripping device of the equipment	-	N/A
7.2.1.2.3	Opening by shunt releases	-	N/A
7.2.1.4 part 1	Limits of operation of shunt releases		
	A shunt release for opening shall cause tripping under all operating conditions of an equipment when the supply voltage of the shunt release measured during the tripping operation remains between 70% and 110% of the rated control supply voltage and, if a.c., at the rated frequency	-	N/A
7.2.1.5 part 1	Limits of operation of current operated relays and releases		
	Limits of operation of current operated relays and releases shall be stated in the relevant product standard	-	N/A

TRF No: IEC60947\_2F



213

IEC 60947-2			
Clause	Requirement + Test	Result - Remark	Verdict
7.2.1.2.4	Opening by over-current releases		
a)	Opening under short-circuit conditions		
	The short-circuit release shall cause tripping of the circuit-breaker with an accuracy of 20% of the tripping current value of the current setting for all values of the current setting of the short-circuit current release	Compliance	P
	Where necessary for over-current co-ordination the manufacturer shall provide information (usually curves) showing	Compliance	P
	- maximum cut-off (let-through) peak current as a function of prospective current (r.m.s. symmetrical)	Compliance	P
	- $I^2t$ characteristics for circuit-breakers of utilization category A and, if applicable, B for circuit-breakers with instantaneous override (see note to 8.3.5)	Compliance	P
b)	Opening under overload conditions		
1)	Instantaneous or definite time-delay operation	-	N/A
	The release shall cause tripping of the circuit-breaker with an accuracy of $\pm 10\%$ of the tripping current value of the current setting for all values of current setting of the overload release	-	N/A
2)	Inverse time-delay operation		
	At the reference temperature and at 1,05 times the current setting with the conventional non-tripping current, the opening release being energized on all poles, tripping shall not occur in less than the conventional time from the cold state, i.e. with the circuit-breaker at the reference temperature	Compliance	P
	Moreover, when at the end of the conventional time the value of current is immediately raised to 1,30 times the current setting, i.e. with the conventional tripping current, tripping shall then occur in less than the conventional time later	Compliance	P
	If a release is declared by the manufacturer as substantially independent of ambient temperature, the current values of table 6 shall apply within the temperature band declared by the manufacturer, within a tolerance of 0,3%/K	Compliance	P

IEC 60947-2			
Clause	Requirement + Test	Result - Remark	Verdict
	The width of the temperature band shall be at least 10 K on either side of the reference temperature	Compliance	P
7.2.4.2	Operational performance capability		
7.2.4.2 part 1	The operational performance off-load for which the tests are made with the control circuits energized and the main circuit not energized, in order to demonstrate that the equipment meets the operating conditions specified at the upper and lower limits of supply voltage and/or pressure specified for the control circuit during closing and opening operations	Compliance	P
	The operational performance on-load during which the equipment shall make and break the specified current corresponding, where relevant, to its utilization category for the number of operations stated in the relevant product standard	Compliance	P
8	TESTS		
8.2.4	Mechanical properties of terminals		
	Mechanical strength of terminals		
	maximum cross-sectional area of conductor (mm <sup>2</sup> ) :	-	
	diameter of thread (mm) :	-	
	torque (Nm) :	-	
	5 times on 2 separate clamping units	-	
	Testing for damage to and accidental loosening of conductor (flexion test)		
	conductor of the smallest cross-sectional area (mm <sup>2</sup> ) :	-	
	number of conductors of the smallest cross section :	-	
	diameter of bushing hole (mm) :	-	
	height between the equipment and the platen :	-	
	mass at the conductor(s) (kg) :	-	
	135 continuous revolutions: the conductor shall neither slip out of the terminal nor break near the clamping unit	-	N/A
	Pull-out test		
	force (N) :	-	

TRF No: IEC60947\_2F

ВЯРНО  
ОПРЕДЕЛЕНИЕ

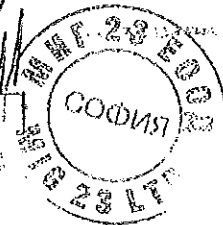

715

IEC 60947-2			
Clause	Requirement + Test	Result - Remark	Verdict
	1 min, the conductor shall neither slip out of the terminal nor break near the clamping unit	-	N/A
	conductor of the largest cross-sectional area (mm <sup>2</sup> ) :	-	
	number of conductors of the largest cross section :	-	
	diameter of bushing hole (mm) :	-	
	height between the equipment and the platen :	-	
	mass at the conductor(s) (kg) :	-	
	135 continuous revolutions: the conductor shall neither slip out of the terminal nor break near the clamping unit	-	N/A
	Pull-out test		
	force (N) :	-	
	1 min, the conductor shall neither slip out of the terminal nor break near the clamping unit	-	N/A
	conductor of the largest and smallest cross-sectional area (mm <sup>2</sup> ) :	-	
	number of conductors of the smallest cross section, number of conductors of the largest cross section :	-	
	diameter of bushing hole (mm) :	-	
	height between the equipment and the platen :	-	
	mass at the conductor(s) (kg) :	-	
	135 continuous revolutions: the conductor shall neither slip out of the terminal nor break near the clamping unit	-	N/A
	Pull-out test		
	force (N) :	-	
	1 min, the conductor shall neither slip out of the terminal nor break near the clamping unit	-	N/A

TRF No. IEC60947\_2F

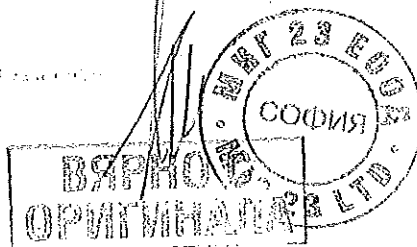

716

IEC 60947-2			
Clause	Requirement + Test	Result - Remark	Verdict
8.3.3	TEST SEQUENCE I: GENERAL PERFORMANCE CHARACTERISTICS		
8.3.3.1	Tripping limits and characteristic		
8.3.3.1.2	Opening under short-circuit conditions		
	Manufacturer's name or trademark	LS	
	Type designation or serial number	TS1600H 3P	
	Sample no:	S1-1	
	Rated operational voltage: Ue (V)	690 V	
	Rated current: In (A)	1600 A	
	Ambient temperature 10-40 °C :	25 °C	P
	Value of the tripping current declared by the manufacturer for a single pole, at which value they shall operate.	3840 A(Ii=2XIn) 28800 A(Ii=15XIn)	P
	Range of adjustable setting current. (A)	Compliance	P
	Time delay stated by the manufacturer, in the case of definite time delay releases.	-	N/A
	<b>Electromagnetic overcurrent releases</b>	-	
	Test current: 80% of the rated, or <b>minimum</b> adjustable setting current: (A)	-	N/A
	Operating time: >0,2s in case of instantaneous releases: L1-L2: L1-L3: L2-L3: N-Lx:	-	N/A
	Operating time: > twice time delay stated by the manufacturer, in the case of definite time delay releases: L1-L2: L1-L3: L2-L3: N-Lx:	-	N/A
	Test current: 120% of the rated, or <b>minimum</b> adjustable setting current: (A)	-	N/A
	Operating time: <0,2s in case of instantaneous releases: L1-L2: L1-L3: L2-L3: N-Lx:	-	N/A

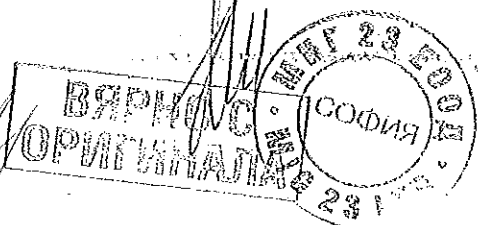

216

IEC 60947-2			
Clause	Requirement + Test	Result - Remark	Verdict
	Operating time: < twice time delay stated by the manufacturer, in the case of definite time delay releases: L1-L2: L1-L3: L2-L3: N-Lx:	-	N/A
	Test current: 80% of the maximum adjustable setting current: (A)	-	N/A
	Operating time: >0,2s in case of instantaneous releases: L1-L2: L1-L3: L2-L3: N-Lx:	-	N/A
	Operating time: > twice time delay stated by the manufacturer, in the case of definite time delay releases: L1-L2: L1-L3: L2-L3: N-Lx:	-	N/A
	Test current: 120% of the maximum adjustable setting current: (A)	Compliance	P
	Operating time: <0,2s in case of instantaneous releases: L1-L2: L1-L3: L2-L3: N-Lx:	-	N/A
	Operating time: < twice time delay stated by the manufacturer, in the case of definite time delay releases: L1-L2: L1-L3: L2-L3: N-Lx:	-	N/A
	Test current: tripping current declared for single pole operation (A)	-	N/A
	Operating time: < 0,2 s in case of instantaneous release: L1: L2: L3: N:	-	N/A
	Operating time: < twice time delay stated by manufacturer in case of definite time delay releases: L1: L2: L3: N:	-	N/A
	<b>Electronic overcurrent releases</b>		

TRF No. IEC60947\_2F

ВЯРНО С  
ОРИГИНАЛА

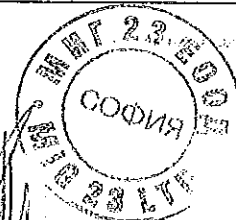

*Handwritten signatures and initials*

IEC 60947-2			
Clause	Requirement + Test	Result - Remark	Verdict
	For circuit-breakers with an electronic overcurrent release, the operation of the short-circuit releases shall be verified by one test only on each pole individually.	Compliance	P
	Test current: 80% of the rated, or minimum adjustable setting current: (A)	2560 A	P
	Operating time: >0,2s in case of instantaneous releases: L1: L2: L3: N:	L1: >0,2 s L2: >0,2 s L3: >0,2 s	P
	Operating time: > twice time delay stated by the manufacturer, in the case of definite time delay releases: L1: L2: L3: N:	-	N/A
	Test current: 120% of the rated, or minimum adjustable setting current: (A)	3840 A	P
	Operating time: <0,2s in case of instantaneous releases: L1: L2: L3: N:	L1: 0,048 s L2: 0,049 s L3: 0,048 s	P
	Operating time: < twice time delay stated by the manufacturer, in the case of definite time delay releases: L1: L2: L3: N:	-	N/A
	Test current: 80% of the maximum adjustable setting current: (A)	19200 A	P
	Operating time: >0,2s in case of instantaneous releases: L1: L2: L3: N:	L1: >0,2 s L2: >0,2 s L3: >0,2 s	P
	Operating time: > twice time delay stated by the manufacturer, in the case of definite time delay releases: L1: L2: L3: N:	-	N/A
	Test current: 120% of the maximum adjustable setting current: (A)	28800 A	P

IEC 60947-2			
Clause	Requirement + Test	Result - Remark	Verdict
	Operating time: <0,2s in case of instantaneous releases: L1: L2: L3: N:	L1: 0,051 s L2: 0,052 s L2: 0,051 s	P
	Operating time: < twice time delay stated by the manufacturer, in the case of definite time delay releases: L1: L2: L3: N:	-	N/A
	<b>Electronic overcurrent releases</b>		
	For circuit-breakers with an electronic overcurrent release, the operation of the short-circuit releases shall be verified by one test only on each pole individually.	Compliance	P
	Test current: 80% of the rated, or <b>minimum</b> adjustable setting current: (A)	768 A(Isd=1,5X0,4XIn)	P
	Operating time: >0,2s in case of instantaneous releases: L1: L2: L3: N:	-	N/A
	Operating time: > twice time delay stated by the manufacturer, in the case of definite time delay releases: L1: L2: L3: N:	L1: >0,1 s L2: >0,1 s L3: >0,1 s	P
	Test current: 120% of the rated, or <b>minimum</b> adjustable setting current: (A)	1152 A(Isd=1,5X0,4XIn)	P
	Operating time: <0,2s in case of instantaneous releases: L1: L2: L3: N:	-	N/A
	Operating time: < twice time delay stated by the manufacturer, in the case of definite time delay releases: L1: L2: L3: N:	L1: 0,068 s L2: 0,068 s L3: 0,063 s	P
	Test current: 80% of the <b>maximum</b> adjustable setting current: (A)	12800 A(Isd=10X1,0XIn)	P



IEC 60947-2			
Clause	Requirement + Test	Result - Remark	Verdict
	Operating time: >0,2s in case of instantaneous releases: L1: L2: L3: N:	-	N/A
	Operating time: > twice time delay stated by the manufacturer, in the case of definite time delay releases: L1: L2: L3: N:	L1: >0,8 s L2: >0,8 s L3: >0,8 s	N/A
	Test current: 120% of the maximum adjustable setting current: (A)	19200 A(Isd=10X1,0XIn)	P
	Operating time: <0,2s in case of instantaneous releases: L1: L2: L3: N:	-	N/A
	Operating time: < twice time delay stated by the manufacturer, in the case of definite time delay releases: L1: L2: L3: N:	L1: 0,417 s L2: 0,417 s L3: 0,417 s	P
8.3.3.1.3	Opening under overload conditions		
a)	Instantaneous or definite time-delay releases		
	Manufacturer's name or trademark		
	Type designation or serial number		
	Sample no:		
	Rated operational voltage: Ue (V)		
	Rated current: In (A)		
	Ambient temperature 10-40 °C :	-	N/A
	Value of the tripping current declared by the manufacturer for a single pole, at which value they shall operate.	-	N/A
	Range of adjustable setting current. (A)	-	N/A
	Time delay stated by the manufacturer, in the case of definite time delay releases.	-	N/A
	Test current: 90% of the rated, or minimum adjustable setting current: (A)	-	N/A

TRF No. IEC60947\_2F

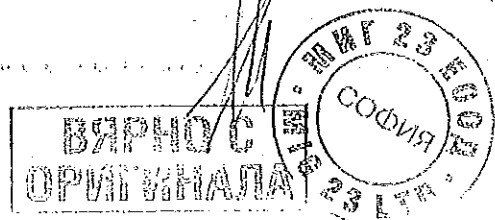

221

IEC 60947-2			
Clause	Requirement + Test	Result - Remark	Verdict
	Operating time: >0,2s in case of instantaneous releases:	-	N/A
	Operating time: > twice time delay stated by the manufacturer, in the case of definite time delay releases.	-	N/A
	Test current: 90% of the maximum adjustable setting current: (A)	-	N/A
	Operating time: >0,2s in case of instantaneous releases	-	N/A
	Operating time: > twice time delay stated by the manufacturer, in the case of definite time delay releases.	-	N/A
	Test current: 110% of the rated, or minimum adjustable setting current: (A) circuit-breaker with neutral pole: 1,2x110% (A)	-	N/A
	Operating time: <0,2s in case of instantaneous releases:	-	N/A
	Operating time: < twice time delay stated by the manufacturer, in the case of definite time delay releases.	-	N/A
	Test current: 110% of the maximum adjustable setting current: (A) circuit-breaker with neutral pole: 1,2x110% (A)	-	N/A
	Operating time: <0,2s in case of instantaneous releases	-	N/A
	Operating time: < twice time delay stated by the manufacturer, in the case of definite time delay releases.	-	N/A
b)	Inverse time delay releases		
	Manufacturer's name or trademark	LS	
	Type designation or serial number	TS1600H 3P	
	Sample no:	S1-1	
	Rated operational voltage: Ue (V)	690 V	
	Rated current: In (A)	1600 A	
	For releases dependent of ambient air temperature: Reference temperature	-	N/A
	Test ambient temperature (°C)	-	N/A

TRF No. IEC60947\_2F

ВЯРНО С  
ОРИГИНАЛА

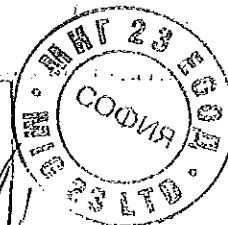

722

IEC 60947-2			
Clause	Requirement + Test	Result - Remark	Verdict
	For releases dependent on ambient air temperature, the operating characteristics shall be verified at the reference temperature, the release being energized on all phase poles. If the test made at a different ambient temperature, a correction shall be made in accordance with the manufacturer's correction temperature/current data	-	N/A
	For thermal-magnetic releases independent of ambient temperature: Tests shall be made at 30°C and 20°C or 40°C, the release being energized on all phase poles	-	N/A
	For electronic releases, the operating characteristic shall be verified at the ambient temperature of the test room (see 6.1.1 of IEC 60947-1), the release being energised on all phase poles.	Compliance	P
	Test ambient air temperature:	25 °C	P
	Range of adjustable setting current: (A)	0,4~1,0 x I <sub>n</sub>	P
	Releases, dependent of ambient air temperature: Reference temperature (°C)	-	N/A
	Thermal Magnetic releases, independent of ambient air temperature: at 30°C	-	N/A
	Test current: 105% of the rated, or <b>minimum</b> adjustable setting current: (A)	672 A (I <sub>r</sub> =0,4X I <sub>n</sub> )	P
	Conventional non-tripping time: 1h when I <sub>n</sub> < 63A, 2h when I <sub>n</sub> > 63 A	2 h	P
	Test current: 130% of the rated, or <b>minimum</b> adjustable setting current: (A)	832 A (I <sub>r</sub> =0,4X I <sub>n</sub> )	P
	For circuit-breakers having an identified neutral pole provided with an overload release (see 8.3.3.1.1), the test current at the conventional tripping current shall be multiplied by the factor 1,2.	-	N/A
	Conventional tripping time: <1h when I <sub>n</sub> < 63A, <2h when I <sub>n</sub> > 63 A	4 s	P
	Test current: 105% of the <b>maximum</b> adjustable setting current: (A)	1680 A (I <sub>r</sub> =1,0X I <sub>n</sub> )	P
	Conventional non-tripping time: 1h when I <sub>n</sub> < 63A, 2h when I <sub>n</sub> > 63 A	2 h	P
	Test current: 130% of the <b>maximum</b> adjustable setting current: (A)	2080 A (I <sub>r</sub> =1,0X I <sub>n</sub> )	P
	For circuit-breakers having an identified neutral pole provided with an overload release (see 8.3.3.1.1), the test current at the conventional tripping current shall be multiplied by the factor 1,2.	-	N/A

TRF No. IEC60947\_2F

ВРНО С  
ОПРЕДНАЈА

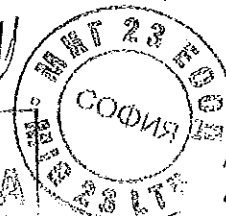

223

IEC 60947-2			
Clause	Requirement + Test	Result - Remark	Verdict
	Conventional tripping time: <1h when $I_n < 63A$ , <2h when $I_n > 63A$	247 s	P
	Thermal Magnetic releases, independent of ambient air temperature: at 20°C or 40°C		
	Test ambient air temperature:	-	N/A
	Test current: 105% of the rated, or minimum adjustable setting current: (A)	-	N/A
	Conventional non-tripping time: 1h when $I_n < 63A$ , 2h when $I_n > 63A$	-	N/A
	Test current: 130% of the rated, or minimum adjustable setting current: (A)	-	N/A
	For circuit-breakers having an identified neutral pole provided with an overload release (see 8.3.3.1.1), the test current at the conventional tripping current shall be multiplied by the factor 1,2.	-	N/A
	Conventional tripping time: <1h when $I_n < 63A$ , <2h when $I_n > 63A$	-	N/A
	Test current: 105% of the maximum adjustable setting current: (A)	-	N/A
	Conventional non-tripping time: 1h when $I_n < 63A$ , 2h when $I_n > 63A$	-	N/A
	Test current: 130% of the maximum adjustable setting current: (A)	-	N/A
	For circuit-breakers having an identified neutral pole provided with an overload release (see 8.3.3.1.1), the test current at the conventional tripping current shall be multiplied by the factor 1,2.	-	N/A
	Conventional tripping time: <1h when $I_n < 63A$ , <2h when $I_n > 63A$	-	N/A
	An additional test, at a current specified by the manufacturer to verify the time/current characteristic of the releases conform to the curves provided by the manufacturer		
	Releases, dependent of ambient air temperature: Reference temperature (°C)	-	N/A
	Releases, independent of ambient air temperature: at 30°C	Compliance	P
	Test ambient air temperature:	25 °C	N/A
	Test current: at current specified by the manufacturer to verify the time/current characteristic of the releases conform to the curves provided by the manufacturer. % of the rated, or minimum adjustable setting current: (% or A)	1920 A (0,4 $I_n$ X 300 %) 4800 A (1,0 $I_n$ X 300%)	P

TRF No. IEC60947\_2F



329

IEC 60947-2			
Clause	Requirement + Test	Result - Remark	Verdict
	Tripping time acc. time/current characteristic of the releases conform to the curves provided by the manufacturer. (within the stated tolerances)	2 s (0,4 In) 88 s (1,0 In)	P
	Releases, independent of ambient air temperature: at 20°C or 40°C		
	Test ambient air temperature:	-	N/A
	Test current: at current specified by the manufacturer to verify the time/current characteristic of the releases conform to the curves provided by the manufacturer. % at the rated, or minimum adjustable setting current: (% or A)	-	N/A
	Tripping time acc. time/current characteristic of the releases conform to the curves provided by the manufacturer. (within the stated tolerances)	-	N/A
8.3.3.1.4	Additional test for definite time-delay releases		
a)	Time delay		
	Test is made at a current equal to 1,5 times the current setting. If the test current overlaps with another tripping characteristic (e.g. an instantaneous tripping characteristic), the trip setting and the test current shall be reduced as necessary to prevent premature tripping.		
	overload releases: (all phase poles loaded)	-	N/A
	for circuit-breakers having an identified neutral pole provided with an overload release, the test current for this release shall be 1,5 times the current setting;	-	N/A
	short-circuit releases	Compliance	P
	Electromagnetic release: two poles in series carrying the test current, using successively all possible combinations of poles having a short-circuit release.	-	N/A
	Electronic releases: on one pole chosen at random.	Compliance	P
	Test current: 1,5 times of the rated, or minimum adjustable setting current: (A)	1440 A (I <sub>sd</sub> =1,5X0,4XIn)	P
	Operating time, overload releases: (s)	-	N/A
	Time-delay: between the limits stated by the manufacturer:	-	N/A
	Operating time, short-circuit releases (electromagnetic): (s) L1-L2: L1-L3: L2-L3:	-	N/A
	Time-delay: between the limits stated by the manufacturer:	-	N/A

TRF No. IEC60947\_2F



725

IEC 60947-2			
Clause	Requirement + Test	Result - Remark	Verdict
	Operating time, <u>short-circuit releases (electronic)</u> : (s) L1: L2: L3:	L1:0,069 s L2:0,060 s L3:0,063 s	P
	Time-delay: between the limits stated by the manufacturer:	0,025 s ~ 0,08 s	P
	Test current: 1,5 times of the maximum adjustable setting current: (A)	24000 A (I <sub>sd</sub> =10X1,0X <sub>I</sub> n)	P
	Operating time, <u>overload releases</u> : (s)	-	N/A
	Time-delay: between the limits stated by the manufacturer:	-	N/A
	Operating time, <u>short-circuit releases (electromagnetic)</u> : (s) L1-L2: L1-L3: L2-L3:	-	N/A
	Time-delay: between the limits stated by the manufacturer:	-	N/A
	Operating time, <u>short-circuit releases (electronic)</u> : (s) L1: L2: L3:	L1:0,417 s L2:0,418 s L3:0,418 s	P
	Time-delay: between the limits stated by the manufacturer:	0,36 ~ 0,44 s	P
b)	Non-tripping duration		
	Firstly, the test current equal to 1,5 times the current setting is maintained for a time interval equal to the non-tripping duration stated by the manufacturer.		
	Then, the current is reduced to the rated current and maintained at this value for twice the time-delay stated by the manufacturer. The circuit-breaker shall not trip.		
	<u>overload releases</u> : (all phase poles loaded)	-	N/A
	for circuit-breakers having an identified neutral pole provided with an overload release, the test current for this release shall be 1,5 times the current setting;	-	N/A
	<u>short-circuit releases</u>	Compliance	P
	Electromagnetic release: two poles in series carrying the test current, using successively all possible combinations of poles having a short-circuit release.	-	N/A
	Electronic releases: on one pole chosen at random.	Compliance	P
	Test current: 1,5 times of the minimum adjustable setting current: (A)	1440 A (I <sub>sd</sub> =1,5X0,4X <sub>I</sub> n)	P

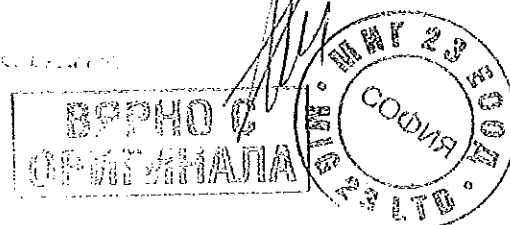

*Handwritten signature*

IEC 60947-2			
Clause	Requirement + Test	Result - Remark	Verdict
	non-tripping duration stated by the manufacturer for overload release: (s)	-	N/A
	non-tripping duration stated by the manufacturer for short-circuit release thermal magnetic: (s)	-	N/A
	non-tripping duration stated by the manufacturer for short-circuit release electronic: (s)	0,025 s	P
	Time duration of current when reduced to the rated current: shall be twice the delay-time stated by the manufacturer: (s)	0,1 s	P
	Rated current	640 A ( $I_r=0,4X I_n$ )	P
	Operating time, <u>overload releases</u> : the circuit-breaker does not trip:	-	N/A
	Operating time, <u>short-circuit releases</u> (electromagnetic), shall not trip: (s) L1-L2: L1-L3: L2-L3:	-	N/A
	Operating time, <u>short-circuit releases</u> (electronic), shall not trip: (s) L1: L2: L3:	L1: >0,1 s L2: >0,1 s L3: >0,1 s	P
	Test current: 1,5 times of <b>maximum</b> adjustable setting current: (A)	24000 A ( $I_{sd}=10X1,0X I_n$ )	P
	non-tripping duration stated by the manufacturer for overload release: (s)	-	N/A
	non-tripping duration stated by the manufacturer for short-circuit release thermal magnetic: (s)	-	N/A
	non-tripping duration stated by the manufacturer for short-circuit release electronic: (s)	0,2 s	P
	Time duration of current when reduced to the rated current: shall be twice the delay-time stated by the manufacturer: (s)	0,8 s	P
	Rated current	1600 A ( $I_r=1,0X I_n$ )	P
	Operating time, <u>overload releases</u> : the circuit-breaker does not trip:	-	N/A
	Operating time, <u>short-circuit releases</u> (electromagnetic), shall not trip: (s) L1-L2: L1-L3: L2-L3:	-	N/A
	Operating time, <u>short-circuit releases</u> (electronic), shall not trip: (s) L1: L2: L3:	L1: >0,8 s L2: >0,8 s L3: >0,8 s	P

TRE No. IEC60947\_2F

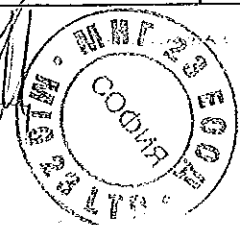
 ВЕРНО  
 КОПИЯ

23

IEC 60947-2			
Clause	Requirement + Test	Result - Remark	Verdict
8.3.3.2	Test of dielectric properties, impulse withstand voltage (Uimp indicated):		
8.3.3.4 part1	The 1,2/50µs impulse voltage shall be applied five times for each polarity at intervals of 1s minimum		
	- rated impulse withstand voltage (kV) :	8 kV	P
	- sea level of the laboratory:	60 m	P
	- test Uimp main circuits (kV) :	9,8 kV	P
	- test Uimp auxiliary circuits (kV) :	-	N/A
	- test Uimp control circuits (kV) :	-	N/A
	- test Uimp on open main contacts (equipment suitable for isolating) (kV) :	12,3 kV	P
a)	Application of test voltage		
	i) Between all terminals of the main circuit connected together (incl. control and auxiliary circuits connected to the main circuit) and the enclosure or mounting plate, with the contacts in all normal positions of operation.	Compliance	P
	ii) Between each pole of the main circuit and the other poles connected together and to the enclosure or mounting plate, with the contacts in all normal positions of operation.	Compliance	P
	iii) Between each control and auxiliary circuit not normally connected to the main circuit and:	Compliance	P
	- the main circuit		
	- other circuits	-	N/A
	- exposed conductive parts	-	N/A
	- enclosure of mounting plate	-	N/A
	iv) equipment suitable for isolation	Compliance	P
	equipment not suitable for isolation	-	N/A
	- no unintentional disruptive discharge during the test's	Compliance	P
	Test of dielectric properties, dielectric withstand voltage (Uimp not indicated):		
	- rated insulation voltage (V) :	1000 V	P
	- main circuits, test voltage for 1 min (V)	2200 V	P
	- auxiliary circuits, test voltage for 1 min (V)	-	N/A
	- control circuits, test voltage for 1 min (V)	-	N/A

TRF No. IEC60947\_2F



231



IEC 60947-2			
Clause	Requirement + Test	Result - Remark	Verdict
8.3.3.2.2	Application of test voltage		
1)	with circuit-breaker in the closed position		
	- between all live parts of all poles connected together and the frame of the circuit-breaker .	Compliance	P
	- between each pole and all the other poles connected to the frame of the circuit-breaker	Compliance	P
2)	with the circuit-breaker in the open position and, additionally, in the tripped position, if any.		
	- between all live parts of all poles connected together and the frame of the circuit-breaker.	Compliance	P
	- between the terminals of one side connected together and the terminals of the other side connected together.	Compliance	P
b)	Control and auxiliary circuits		
1)	- between all the control and auxiliary circuits which are not normally connected to the main circuit, connected together, and the frame of the circuit-breaker.	-	N/A
2)	- where appropriate, between each part of the control an auxiliary circuits which may be isolated from the other parts during normal operation and all the other parts connected together.	-	N/A
	No unintentional disruptive discharge during the tests	Compliance	P
8.3.3.2	For circuit-breaker suitable for isolation, the leakage current shall be measured through each pole with the contacts in the open position, at a test voltage of 1,1 Ue, and shall not exceed 0,5mA.	≤ 0,01 mA / 759 V	P
8.3.3.3	Mechanical operation and operational performance capability		
8.3.3.3.2	Construction and mechanical operation		
a)	Construction		
	A withdrawable circuit-breaker shall be checked for the requirements stated in 7.1.1	-	N/A
	A circuit-breaker with stored energy operation shall be checked for compliance with 7.2.1.1.5, regarding the charge indicator and the direction of operation of manual energy storing .	-	N/A
b)	Mechanical operation		
	A circuit-breaker with dependent power operation shall comply with the requirements stated in 7.2.1.1.3	-	N/A

IEC 60947-2			
Clause	Requirement + Test	Result - Remark	Verdict
	A circuit-breaker with dependent power operation shall operate with the operating mechanism charged to the minimum and maximum limits stated by the manufacturer	-	N/A
	A circuit-breaker with stored energy operation shall comply with the requirements stated in 7.2.1.5 with the auxiliary supply voltage at 85% and 110% of the rated control supply voltage.	-	N/A
	It shall also be verified that the moving contacts cannot be moved from the open position when the operating mechanism is charged to slightly below the full charge as evidenced by the indicating device	-	N/A
	For a trip-free circuit-breaker it shall not be possible to maintain the contacts in the touching or closed position when the tripping release is in the position to trip the circuit-breaker	-	N/A
	If the closing and opening times of a circuit-breaker are stated by the manufacturer, such times shall comply with the stated values	-	N/A
c)	Undervoltage releases		
	Undervoltage releases shall comply with the requirements of 7.2.1.3 of Part 1. For this purpose, the release shall be fitted to a circuit-breaker having the maximum current rating for which the release is suitable	-	N/A
i)	Drop out voltage		
	It shall be verified that the release operates to open the circuit-breaker between the voltage limits specified	-	N/A
	The voltage shall be reduced from rated voltage at a rate to reach 0 V in approximately 30 s	-	N/A
	The test for the lower limit is made without current in the main circuit and without previous heating of the release coil	-	N/A
	In the case of a release with a range of rated voltages, this test applies to the maximum voltage of the range	-	N/A
	The test for the upper limit is made starting from a constant temperature corresponding to the application of rated control supply voltage to the release and rated current in the main poles of the circuit-breaker	-	N/A
	This test may be combined with the temperature-rise test of 8.3.5.6	-	N/A

TRF No. IEC60947\_2F

ВЕРНО С  
ОРИГИНАЛА

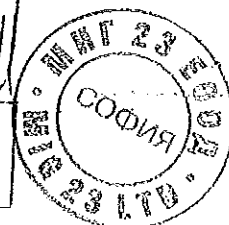

F253

IEC 60947-2			
Clause	Requirement + Test	Result - Remark	Verdict
	In the case of a release with a range of rated voltages, this test is made at both the minimum and maximum rated control supply voltages	-	N/A
ii)	Test for limits of operation		
	Starting with the circuit-breaker open, at the temperature of the test room, and with the supply voltage at 30% rated maximum control supply voltage, it shall be verified that the circuit-breaker cannot be closed by the operation of the actuator	-	N/A
	When the supply voltage is raised to 85% of the minimum control supply voltage, it shall be verified that the circuit-breaker can be closed by the operation of the actuator	-	N/A
iii)	Performance under overvoltage conditions		
	With the circuit-breaker closed and without current in the main circuit, it shall be verified that the undervoltage release will withstand the application of 110% rated control supply voltage for 4 h without impairing its functions	-	N/A
d)	Shunt releases		
	Shunt releases shall comply with the requirements of 7.2.1.4 of Part 1. For this purpose, the release shall be fitted to a circuit-breaker having the maximum rated current for which the release is suitable	-	N/A
	It shall be verified that the release will operate to open the circuit-breaker at 70% rated control supply voltage when tested at an ambient temperature of $+ 55\text{ }^{\circ}\text{C} \pm 2\text{ }^{\circ}\text{C}$ without current in the main poles of the circuit-breaker	-	N/A
	In the case of a release having a range of rated control supply voltages, the test voltage shall be 70% of the minimum rated control supply voltage	-	N/A
8.3.3.3.3	Operational performance capability without current.		
	Type designation or serial number	TS1600H 3P	
	Sample no:	S1-1	
	Rated current $I_n$ (A)	1600 A	
	Rated operational voltage: $U_e$ (V)	690 V	
	Rated control supply voltage of closing mechanism: $U_c$ (V)		
	Rated control supply voltage of shunt releases: $U_c$ (V)		

IEC 60947-2			
Clause	Requirement + Test	Result - Remark	Verdict
	Rated control supply voltage undervoltage releases: U <sub>c</sub> (V)		
	Ambient temperature 10-40 °C :	25 °C	P
	Number of operating cycles per hour	20 Cycles per hour	P
	Number of cycles without current (total) (closing mechanism energized at the rated U <sub>c</sub> )	-	N/A
	Number of cycles without current (without releases)	2500 Cycles	P
	Applied voltage: closing mechanism (V)	-	N/A
	10% of total cycles for circuit-breaker with fitted shunt release: (50% at the beginning- and 50% at the end of the test.) Energized at the rated U <sub>c</sub>	-	N/A
	Applied voltage: shunt releases (V)	-	N/A
	10% of total cycles for circuit-breaker with undervoltage releases: (50% at the beginning- and 50% at the end of the test.) Energized at the minimum rated U <sub>c</sub>	-	N/A
	10 cycles without applied voltage at the undervoltage releases. (Shall not possible to close the circuit-breaker.)	-	N/A
	Applied voltage: undervoltage releases (V)	-	N/A
	Electrical components do not exceed the value indicated in tab. 7.	Compliance	P
8.3.3.3.4	Operational performance capability with current.		
	Rated current: I <sub>n</sub> (A)	1600 A	
	Maximum rated operational voltage: U <sub>e</sub> (V)	690 V	
	Conductor cross-sectional area (mm <sup>2</sup> ) :	500 mm <sup>2</sup> X 2	P
	Number of operating cycles per hour	20 Cycles per hour	P
	Number of cycles with current (total) (closing mechanism energized at the rated U <sub>c</sub> )	500 Cycles	P
	Applied voltage: closing mechanism (V)	-	N/A
	For circuit-breaker fitted with adjustable releases, test shall be made with the overload setting at maximum and short-circuit setting at minimum.	Compliance	P
	Conditions, make/break operations:		
	- test voltage U/U <sub>e</sub> = 1,0 (V) ..... L1:	L1: 691,8 V	P
	..... L2:	L2: 700,8 V	
	..... L3:	L3: 708,3 V	



IEC 60947-2			
Clause	Requirement + Test	Result - Remark	Verdict
	- test current I/le = 1,0 (A)..... L1: ..... L2: ..... L3:	L1: 1618 A L2: 1625 A L3: 1602 A	P
	- power factor/time constant:	0,73	P
	- frequency: (Hz)	60 Hz	P
	- on-time (ms):	1000 ms	P
	- off-time (s):	179 s	P
	Electrical components do not exceed the value indicated in tab. 7.	Compliance	P
8.3.3.3.5	Additional test of operational performance capability without current for withdrawable circuit-breaker.		
	Number of operations cycles : 100	-	N/A
	After test, the isolating contacts, withdrawable mechanism and interlocks shall be suitable for further service.	-	N/A
8.3.3.4	Overload performance		
	this test applies to circuit-breaker of rated current up to and including 630 A		
	Type designation or serial number		
	Sample no:		
	Rated current In (A)		
	Rated operational voltage: Ue (V)		
	Rated control supply voltage of closing mechanism: Uc (V)		
	Rated control supply voltage of shunt releases: Uc (V)		
	Rated control supply voltage undervoltage releases: Uc (V)		
	Ambient temperature 10-40 °C :	-	N/A
	Number of operating cycles per hour	-	N/A
	Maximum rated operational voltage: Ue (V)	-	N/A
	Number of operating cycles per hour	-	N/A
	Number of cycles with current (total) (closing mechanism energized at the rated Uc)	-	N/A
	Applied voltage: closing mechanism (V)	-	N/A

IEC 60947-2			
Clause	Requirement + Test	Result - Remark	Verdict
	For circuit-breaker fitted with adjustable releases, test shall be made with the overload/short-circuit settings at maximum.	-	N/A
	Conditions, overload operations:		
	- test voltage $U/U_e = 1,05$ (V) ..... L1: ..... L2: ..... L3:	-	N/A
	- test current AC/DC: $I/I_e = 6,0/2.5$ (A) ..... L1: ..... L2: ..... L3:	-	N/A
	- power factor/time constant:	-	N/A
	- Number of cycles manually opened: 9	-	N/A
	- Number of cycles automatically opened by an overload release: 3	-	N/A
	- frequency: (Hz)	-	N/A
	- on-time max 2s:	-	N/A
8.3.3.5	Verification of dielectric withstand		
	- equal to twice the rated operational voltage with a minimum of 1000 V for 5 seconds	1380 V	P
	- no breakdown or flashover	No	P
	For circuit-breaker suitable for isolation, the leakage current shall be measured through each pole with the contacts in the open position, at a test voltage of 1,1 $U_e$ , and shall not exceed 2 mA.	$\leq 0,02$ mA / 759 V	P
8.3.3.6	Verification of temperature-rise		
****	- the values of temperature-rise do not exceed those specified in tab. 7.	See table S1-1 (3P)	P
	Temperature rise of main circuit terminals $\leq 80$ K (K) :	$\leq 73,3$ K	P
	conductor cross-sectional area (mm <sup>2</sup> ) :	500 mm <sup>2</sup> x 2	P
	test current $I_e$ (A) :	1600 A	P
8.3.3.7	Verification of overload releases		
	Test current: 1.45 times the value of their current setting at the reference temperature: (A) .....	2320 A	P
	Conventional tripping time: <1h when $I_n < 63A$ , <2h when $I_n > 63 A$	542 s	P

TRF No: IEC60947-2F

ВЕРНО С  
ОРИГИНАЛА

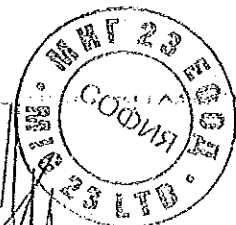

257

IEC 60947-2			
Clause	Requirement + Test	Result - Remark	Verdict
8.3.3.8	Verification of undervoltage and shunt releases		
	Circuit-breaker fitted with undervoltage releases. The release shall not operate at 70% of the minimum control supply voltage -	-	N/A
	and shall operate at 35% of the maximum control supply voltage.	-	N/A
	Circuit-breaker fitted with shunt releases. The release shall operate at 70% of the minimum rated control supply voltage. Test made at room temperature.	-	N/A
8.3.3.9	Verification of the main contact position for circuit-breakers for isolation		
	actuating force for opening (N) .....	206 N	—
	test force with blocked main contacts for 10 s (N) ..	618 N	—
	Dependent power operation	-	N/A
	Supply voltage of 110% of rated voltage (V).....:	-	N/A
	Three attempts of 5 s to operate the equipment at intervals of 5 min.	-	N/A
	Independent power operation	-	N/A
	Three attempts to operate the equipment by the stored energy.	-	N/A
	Lock ability of driving mechanism in OFF-position at test force and blocked main contacts .....	-	N/A
	Position indicator does not show OFF-position after capture of test force at blocked main contacts	Compliance	P

8.3.3	TEST SEQUENCE I: GENERAL PERFORMANCE CHARACTERISTICS		
8.3.3.1	Tripping limits and characteristic		
8.3.3.1.2	Opening under short-circuit conditions		
	Manufacturer's name or trademark	LS	
	Type designation or serial number	TS1600H 4P	
	Sample no:	S1-1	
	Rated operational voltage: Ue (V)	690 V	
	Rated current: In (A)	1600 A	
	Ambient temperature 10-40 °C :	25 °C	P

TRF No. IEC60947\_2F



Official stamps and handwritten notes at the bottom right of the page, including a circular stamp with 'МНГ 23' and 'COOR' and a rectangular stamp with 'ВРНО С' and 'ОПРЕДЕЛЕНИЯ'.

736

IEC 60947-2			
Clause	Requirement + Test	Result - Remark	Verdict
	Value of the tripping current declared by the manufacturer for a single pole, at which value they shall operate.	3840 A( $I_i=2X I_n$ ) 28800 A( $I_i=15X I_n$ )	P
	Range of adjustable setting current. (A)	Compliance	P
	Time delay stated by the manufacturer, in the case of definite time delay releases.	-	N/A
	<b>Electromagnetic overcurrent releases</b>		
	Test current: 80% of the rated, or <b>minimum</b> adjustable setting current: (A)	-	N/A
	Operating time: >0,2s in case of instantaneous releases: L1-L2: L1-L3: L2-L3: N-Lx:	-	N/A
	Operating time: > twice time delay stated by the manufacturer, in the case of definite time delay releases: L1-L2: L1-L3: L2-L3: N-Lx:	-	N/A
	Test current: 120% of the rated, or <b>minimum</b> adjustable setting current: (A)	-	N/A
	Operating time: <0,2s in case of instantaneous releases: L1-L2: L1-L3: L2-L3: N-Lx:	-	N/A
	Operating time: < twice time delay stated by the manufacturer, in the case of definite time delay releases: L1-L2: L1-L3: L2-L3: N-Lx:	-	N/A
	Test current: 80% of the <b>maximum</b> adjustable setting current: (A)	-	N/A
	Operating time: >0,2s in case of instantaneous releases: L1-L2: L1-L3: L2-L3: N-Lx:	-	N/A

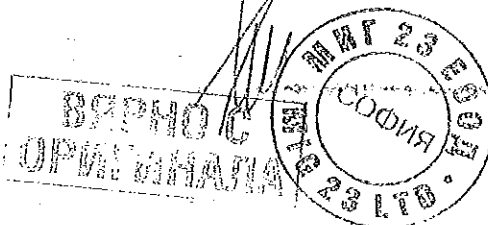



IEC 60947-2			
Clause	Requirement + Test	Result - Remark	Verdict
	Operating time: > twice time delay stated by the manufacturer, in the case of definite time delay releases: L1-L2: L1-L3: L2-L3: N-Lx:	-	N/A
	Test current: 120% of the maximum adjustable setting current: (A)	Compliance	P
	Operating time: <0,2s in case of instantaneous releases: L1-L2: L1-L3: L2-L3: N-Lx:	-	N/A
	Operating time: < twice time delay stated by the manufacturer, in the case of definite time delay releases: L1-L2: L1-L3: L2-L3: N-Lx:	-	N/A
	Test current: tripping current declared for single pole operation (A)	-	N/A
	Operating time: < 0,2 s in case of instantaneous release: L1: L2: L3: N:	-	N/A
	Operating time: < twice time delay stated by manufacturer in case of definite time delay releases L1: L2: L3: N:	-	N/A
	<b>Electronic overcurrent releases</b>		
	For circuit-breakers with an electronic overcurrent release, the operation of the short-circuit releases shall be verified by one test only on each pole individually.	Compliance	P
	Test current: 80% of the rated, or minimum adjustable setting current: (A)	2560 A(Ii=2XIn)	P
	Operating time: >0,2s in case of instantaneous releases: L1: L2: L3: N:	L1: >0,2 s L2: >0,2 s L3: >0,2 s N:	P

(

(

IEC 60947-2			
Clause	Requirement + Test	Result - Remark	Verdict
	Operating time: > twice time delay stated by the manufacturer, in the case of definite time delay releases: L1: L2: L3: N:	-	N/A
	Test current: 120% of the rated, or minimum adjustable setting current: (A)	3840 A(Ii=2XIn)	P
	Operating time: <0,2s in case of instantaneous releases: L1: L2: L3: N:	L1: 0,050 s L2: 0,049 s L3: 0,049 s	P
	Operating time: < twice time delay stated by the manufacturer, in the case of definite time delay releases: L1: L2: L3: N:	-	N/A
	Test current: 80% of the maximum adjustable setting current: (A)	19200 A(Ii=15XIn)	P
	Operating time: >0,2s in case of instantaneous releases: L1: L2: L3: N:	L1: >0,2 s L2: >0,2 s L3: >0,2 s	P
	Operating time: > twice time delay stated by the manufacturer, in the case of definite time delay releases: L1: L2: L3: N:	-	N/A
	Test current: 120% of the maximum adjustable setting current: (A)	28800 A(Ii=15XIn)	P
	Operating time: <0,2s in case of instantaneous releases: L1: L2: L3: N:	L1: 0,050 s L2: 0,050 s L3: 0,049 s	P
	Operating time: < twice time delay stated by the manufacturer, in the case of definite time delay releases: L1: L2: L3: N:	-	N/A
	<b>Electronic overcurrent releases</b>		

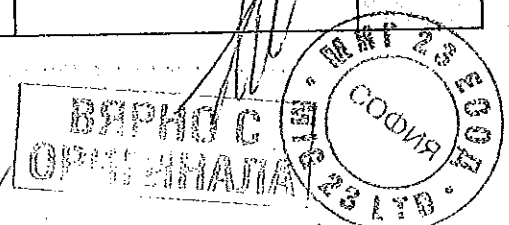

(

(

IEC 60947-2			
Clause	Requirement + Test	Result - Remark	Verdict
	For circuit-breakers with an electronic overcurrent release, the operation of the short-circuit releases shall be verified by one test only on each pole individually.	Compliance 	P
	Test current: 80% of the rated, or <b>minimum</b> adjustable setting current: (A)	768 A(I <sub>sd</sub> =1,5X0,4X <sub>In</sub> )	P
	Operating time: >0,2s in case of instantaneous releases: L1: L2: L3: N:	-	N/A
	Operating time: > twice time delay stated by the manufacturer, in the case of definite time delay releases: L1: L2: L3: N:	L1: >0,1 s L2: >0,1 s L3: >0,1 s	P
	Test current: 120% of the rated, or <b>minimum</b> adjustable setting current: (A)	1152 A(I <sub>sd</sub> =1,5X0,4X <sub>In</sub> )	P
	Operating time: <0,2s in case of instantaneous releases: L1: L2: L3: N:	-	N/A
	Operating time: < twice time delay stated by the manufacturer, in the case of definite time delay releases: L1: L2: L3: N:	L1: 0,068 s L2: 0,072 s L3: 0,065 s	P
	Test current: 80% of the <b>maximum</b> adjustable setting current: (A)	12800 A(I <sub>sd</sub> =10X1,0X <sub>In</sub> )	P
	Operating time: >0,2s in case of instantaneous releases: L1: L2: L3: N:	-	N/A
	Operating time: > twice time delay stated by the manufacturer, in the case of definite time delay releases: L1: L2: L3: N:	L1: >0,8 s L2: >0,8 s L3: >0,8 s	N/A
	Test current: 120% of the <b>maximum</b> adjustable setting current: (A)	19200 A(I <sub>sd</sub> =10X1,0X <sub>In</sub> )	P

TRF No: IEC60947\_2F

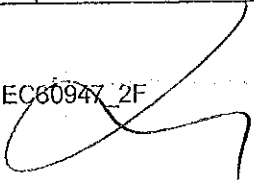
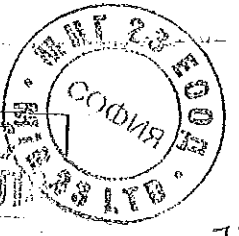
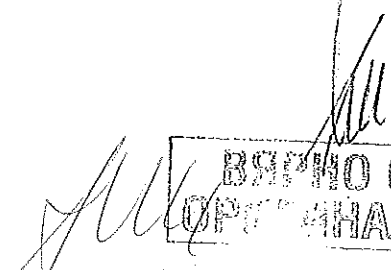

(

(

IEC 60947-2			
Clause	Requirement + Test	Result - Remark	Verdict
	Operating time: <0,2s in case of instantaneous releases: L1: L2: L3: N:	- 	N/A
	Operating time: < twice time delay stated by the manufacturer, in the case of definite time delay releases: L1: L2: L3: N:	L1: 0,418 s L2: 0,418 s L3: 0,418 s	P
8.3.3.1.3	Opening under overload conditions		
a)	Instantaneous or definite time-delay releases		
	Manufacturer's name or trademark		
	Type designation or serial number		
	Sample no:		
	Rated operational voltage: Ue (V)		
	Rated current: In (A)		
	Ambient temperature 10-40 °C :	-	N/A
	Value of the tripping current declared by the manufacturer for a single pole, at which value they shall operate.	-	N/A
	Range of adjustable setting current. (A)	-	N/A
	Time delay stated by the manufacturer, in the case of definite time delay releases.	-	N/A
	Test current: 90% of the rated, or minimum adjustable setting current: (A)	-	N/A
	Operating time: >0,2s in case of instantaneous releases:	-	N/A
	Operating time: > twice time delay stated by the manufacturer, in the case of definite time delay releases.	-	N/A
	Test current: 90% of the maximum adjustable setting current: (A)	-	N/A
	Operating time: >0,2s in case of instantaneous releases	-	N/A
	Operating time: > twice time delay stated by the manufacturer, in the case of definite time delay releases.	-	N/A

TRF No. IEC60947\_2F

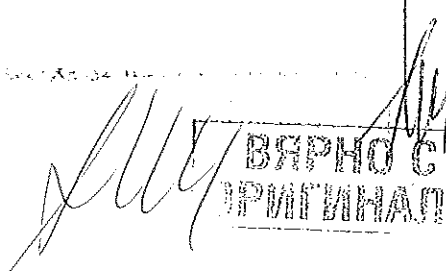
01.06.2018 10:34

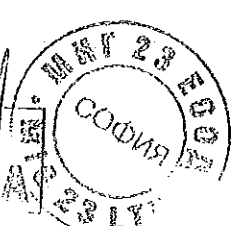
713

C

C



IEC 60947-2			
Clause	Requirement + Test	Result - Remark	Verdict
	Test current: 110% of the rated, or minimum adjustable setting current: (A) circuit-breaker with neutral pole: 1,2x110% (A)	-	N/A
	Operating time: <0,2s in case of instantaneous releases:	-	N/A
	Operating time: < twice time delay stated by the manufacturer, in the case of definite time delay releases.	-	N/A
	Test current: 110% of the maximum adjustable setting current: (A) circuit-breaker with neutral pole: 1,2x110% (A)	-	N/A
	Operating time: <0,2s in case of instantaneous releases	-	N/A
	Operating time: < twice time delay stated by the manufacturer, in the case of definite time delay releases.	-	N/A
b)	Inverse time delay releases		
	Manufacturer's name or trademark	LS	
	Type designation or serial number	TS1600H 4P	
	Sample no:	S1-1	
	Rated operational voltage: Ue (V)	690 V	
	Rated current: In (A)	1600 A	
	For releases dependent of ambient air temperature: Reference temperature	-	N/A
	Test ambient temperature (°C )	-	N/A
	For releases dependent on ambient air temperature, the operating characteristics shall be verified at the reference temperature, the release being energized on all phase poles. If the test made at a different ambient temperature, a correction shall be made in accordance with the manufacturer's correction temperature/current data	-	N/A
	For thermal-magnetic releases independent of ambient temperature: Tests shall be made at 30°C and 20°C or 40°C, the release being energized on all phase poles	-	N/A
	For electronic releases, the operating characteristic shall be verified at the ambient temperature of the test room (see 6.1.1 of IEC 60947-1), the release being energised on all phase poles.	Compliance	P

TRF No: IEC60947-2

ВЕРНО С  
ОРИГИНАЛА

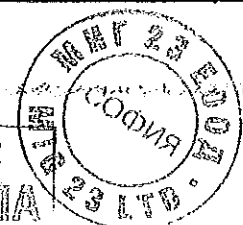

794

(

(

IEC 60947-2			
Clause	Requirement + Test	Result - Remark	Verdict
	Test ambient air temperature:	25 °C	P
	Range of adjustable setting current: (A)	0,4~1,0 x In	P
	Releases, dependent of ambient air temperature: Reference temperature (°C)	-	N/A
	Thermal Magnetic releases, independent of ambient air temperature: at 30°C	-	N/A
	Test current: 105% of the rated, or <b>minimum</b> adjustable setting current: (A)	672 A (Ir=0,4XIn)	P
	Conventional non-tripping time: 1h when In < 63A, 2h when In > 63 A	2 h	P
	Test current: 130% of the rated, or <b>minimum</b> adjustable setting current: (A)	832 A (Ir=0,4XIn)	P
	For circuit-breakers having an identified neutral pole provided with an overload release (see 8.3.3.1.1), the test current at the conventional tripping current shall be multiplied by the factor 1,2.	998 A (Ir=0,4XIn)	P
	Conventional tripping time: <1h when In < 63A, <2h when In > 63 A	5 s / 5 s	P
	Test current: 105% of the <b>maximum</b> adjustable setting current: (A)	1680 A (Ir=1,0XIn)	P
	Conventional non-tripping time: 1h when In < 63A, 2h when In > 63 A	2 h	P
	Test current: 130% of the <b>maximum</b> adjustable setting current: (A)	2080 A (Ir=1,0XIn)	P
	For circuit-breakers having an identified neutral pole provided with an overload release (see 8.3.3.1.1), the test current at the conventional tripping current shall be multiplied by the factor 1,2.	2496 A (Ir=1,0XIn)	P
	Conventional tripping time: <1h when In < 63A, <2h when In > 63 A	318 s / 145 s	P
	Thermal Magnetic releases, independent of ambient air temperature: at 20°C or 40°C		
	Test ambient air temperature:	-	N/A
	Test current: 105% of the rated, or <b>minimum</b> adjustable setting current: (A)	-	N/A
	Conventional non-tripping time: 1h when In < 63A, 2h when In > 63 A	-	N/A
	Test current: 130% of the rated, or <b>minimum</b> adjustable setting current: (A)	-	N/A

TRF No. IEC60947\_2F

ВЕРНО С  
ОРИГИНАЛА

ММГ 23 000  
СОДИА

795

C.

C.

IEC 60947-2			
Clause	Requirement + Test	Result - Remark	Verdict
	For circuit-breakers having an identified neutral pole provided with an overload release (see 8.3.3.1.1), the test current at the conventional tripping current shall be multiplied by the factor 1,2.	-	N/A
	Conventional tripping time: <1h when $I_n < 63A$ , <2h when $I_n > 63 A$	-	N/A
	Test current: 105% of the maximum adjustable setting current: (A)	-	N/A
	Conventional non-tripping time: 1h when $I_n < 63A$ , 2h when $I_n > 63 A$	-	N/A
	Test current: 130% of the maximum adjustable setting current: (A)	-	N/A
	For circuit-breakers having an identified neutral pole provided with an overload release (see 8.3.3.1.1), the test current at the conventional tripping current shall be multiplied by the factor 1,2.	-	N/A
	Conventional tripping time: <1h when $I_n < 63A$ , <2h when $I_n > 63 A$	-	N/A
	An additional test, at a current specified by the manufacturer to verify the time/current characteristic of the releases conform to the curves provided by the manufacturer		
	Releases, dependent of ambient air temperature: Reference temperature (°C)	Compliance	P
	Releases, independent of ambient air temperature: at 30°C	Compliance	P
	Test ambient air temperature:	25 °C	N/A
	Test current: at current specified by the manufacturer to verify the time/current characteristic of the releases conform to the curves provided by the manufacturer. % at the rated, or minimum adjustable setting current: (% or A)	1920 A (0,4 $I_n$ X 300 %) 4800 A (1,0 $I_n$ X 300 %)	P
	Tripping time acc. time/current characteristic of the releases conform to the curves provided by the manufacturer. (within the stated tolerances)	2 s (0,4 $I_n$ ) 89 s (1,0 $I_n$ )	P
	Releases, independent of ambient air temperature: at 20°C or 40°C		
	Test ambient air temperature:	-	N/A
	Test current: at current specified by the manufacturer to verify the time/current characteristic of the releases conform to the curves provided by the manufacturer. % at the rated, or minimum adjustable setting current: (% or A)	-	N/A

TRF\*№ IEC60947\_2F

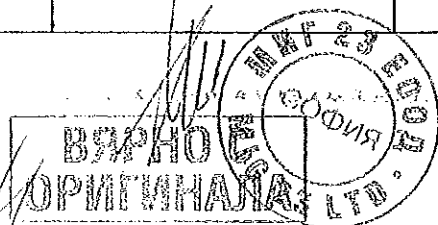

726

C.

C.

IEC 60947-2			
Clause	Requirement + Test	Result - Remark	Verdict
	Tripping time acc. time/current characteristic of the releases conform to the curves provided by the manufacturer. (within the stated tolerances)	-	N/A
8.3.3.1.4	Additional test for definite time-delay releases		
a)	Time delay		
	Test is made at a current equal to 1,5 times the current setting. If the test current overlaps with another tripping characteristic (e.g. an instantaneous tripping characteristic), the trip setting and the test current shall be reduced as necessary to prevent premature tripping.		
	<u>overload releases</u> : (all phase poles loaded)	-	N/A
	for circuit-breakers having an identified neutral pole provided with an overload release, the test current for this release shall be 1,5 times the current setting;	-	N/A
	<u>short-circuit releases</u>	Compliance	P
	Electromagnetic release: two poles in series carrying the test current, using successively all possible combinations of poles having a short-circuit release.	-	N/A
	Electronic releases: on one pole chosen at random.	Compliance	P
	Test current: 1,5 times of the rated, or <b>minimum</b> adjustable setting current: (A)	1440 A (I <sub>sd</sub> =1,5X0,4XIn)	P
	Operating time, <u>overload releases</u> : (s)	-	N/A
	Time-delay: between the limits stated by the manufacturer:	-	N/A
	Operating time, <u>short-circuit releases</u> (electromagnetic): (s) L1-L2: L1-L3: L2-L3:	-	N/A
	Time-delay: between the limits stated by the manufacturer:	-	N/A
	Operating time, <u>short-circuit releases</u> (electronic): (s) L1: L2: L3:	L1:0,067 s L2:0,067 s L3:0,068 s	P
	Time-delay: between the limits stated by the manufacturer:	0,025 s ~ 0,08 s	P
	Test current: 1,5 times of the <b>maximum</b> adjustable setting current: (A)	24000 A (I <sub>sd</sub> =10X1,0XIn)	P
	Operating time, <u>overload releases</u> : (s)	-	N/A

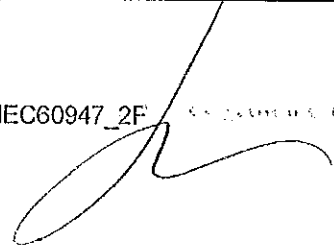

STANHO C  
OPATNAJIA

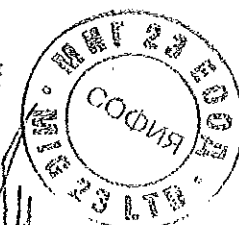

C.

C.



IEC 60947-2			
Clause	Requirement + Test	Result - Remark	Verdict
	Time-delay: between the limits stated by the manufacturer:	-	N/A
	Operating time, <u>short-circuit releases (electromagnetic)</u> : (s) L1-L2: L1-L3: L2-L3:	-	N/A
	Time-delay: between the limits stated by the manufacturer:	-	N/A
	Operating time, <u>short-circuit releases (electronic)</u> : (s) L1: L2: L3:	L1:0,418 s L2:0,419 s L3:0,419 s	P
	Time-delay: between the limits stated by the manufacturer:	0,36 ~ 0,44 s	P
b)	Non-tripping duration		
	Firstly, the test current equal to 1,5 times the current setting is maintained for a time interval equal to the non-tripping duration stated by the manufacturer.		
	Then, the current is reduced to the rated current and maintained at this value for twice the time-delay stated by the manufacturer. The circuit-breaker shall not trip.		
	<u>overload releases</u> : (all phase poles loaded)	-	N/A
	for circuit-breakers having an identified neutral pole provided with an overload release, the test current for this release shall be 1,5 times the current setting;	-	N/A
	<u>short-circuit releases</u>	Compliance	P
	Electromagnetic release: two poles in series carrying the test current, using successively all possible combinations of poles having a short-circuit release.	-	N/A
	Electronic releases: on one pole chosen at random.	Compliance	P
	Test current: 1,5 times of the <b>minimum</b> adjustable setting current: (A)	1440 A (I <sub>sd</sub> =1,5X0,4XIn)	P
	non-tripping duration stated by the manufacturer for overload release: (s)	-	N/A
	non-tripping duration stated by the manufacturer for short-circuit release thermal magnetic: (s)	-	N/A
	non-tripping duration stated by the manufacturer for short-circuit release electronic: (s)	0,025 s	P
	Time duration of current when reduced to the rated current: shall be twice the delay-time stated by the manufacturer: (s)	0,1 s	P



(

(

IEC 60947-2			
Clause	Requirement + Test	Result - Remark	Verdict
	Rated current	640 A (Ir=0,4XIn)	P
	Operating time, <u>overload releases</u> : the circuit-breaker does not trip:	-	N/A
	Operating time, <u>short-circuit releases</u> (electromagnetic), shall not trip: (s)      L1-L2: L1-L3: L2-L3:	-	N/A
	Operating time, <u>short-circuit releases</u> (electronic), shall not trip: (s)      L1: L2: L3:	L1: >0,1 s L2: >0,1 s L3: >0,1 s	P
	Test current: 1,5 times of <b>maximum</b> adjustable setting current: (A)	24000 A (Isd=10X1,0XIn)	P
	non-tripping duration stated by the manufacturer for overload release: (s)	-	N/A
	non-tripping duration stated by the manufacturer for short-circuit release thermal magnetic: (s)	-	N/A
	non-tripping duration stated by the manufacturer for short-circuit release electronic: (s)	0,2 s	P
	Time duration of current when reduced to the rated current: shall be twice the delay-time stated by the manufacturer: (s)	0,8 s	P
	Rated current	1600 A (Ir=1,0XIn)	P
	Operating time, <u>overload releases</u> : the circuit-breaker does not trip:	-	N/A
	Operating time, <u>short-circuit releases</u> (electromagnetic), shall not trip: (s)      L1-L2: L1-L3: L2-L3:	-	N/A
	Operating time, <u>short-circuit releases</u> (electronic), shall not trip: (s)      L1: L2: L3:	L1: >0,8 s L2: >0,8 s L3: >0,8 s	P
8.3.3.2	Test of dielectric properties, impulse withstand voltage (Uimp indicated):		
8.3.3.4 part1	The 1,2/50µs impulse voltage shall be applied five times for each polarity at intervals of 1s minimum		
	- rated impulse withstand voltage (kV) :	8 kV	P
	- sea level of the laboratory:	60 m	P
	- test Uimp main circuits (kV) :	9,8 kV	P
	- test Uimp/auxiliary circuits (kV) :	-	N/A

TRF No. IEC60947\_2F

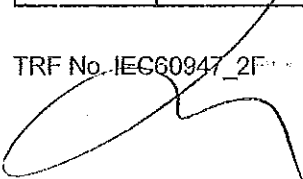

ВЯРНО С  
ОПРИЗНАНА

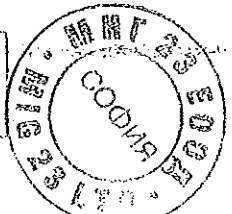
719

(

(

IEC 60947-2			
Clause	Requirement + Test	Result - Remark	Verdict
	- test Uimp control circuits (kV) :	-	N/A
	- test Uimp on open main contacts (equipment suitable for isolating) (kV) :	12,3 kV	P
a)	Application of test voltage		
	i) Between all terminals of the main circuit connected together (incl. control and auxiliary circuits connected to the main circuit) and the enclosure or mounting plate, with the contacts in all normal positions of operation.	Compliance	P
	ii) Between each pole of the main circuit and the other poles connected together and to the enclosure or mounting plate, with the contacts in all normal positions of operation.	Compliance	P
	iii) Between each control and auxiliary circuit not normally connected to the main circuit and:	Compliance	P
	- the main circuit		
	- other circuits	-	N/A
	- exposed conductive parts	-	N/A
	- enclosure of mounting plate	-	N/A
	iv) equipment suitable for isolation	Compliance	P
	equipment not suitable for isolation		N/A
	- no unintentional disruptive discharge during the test's	Compliance	P
	Test of dielectric properties, dielectric withstand voltage (Uimp not indicated):		
	- rated insulation voltage (V) :	1000 V	P
	- main circuits, test voltage for 1 min (V)	2200 V	P
	- auxiliary circuits, test voltage for 1 min (V)	-	N/A
	- control circuits, test voltage for 1 min (V)	-	N/A
8.3.3.2.2	Application of test voltage		
1)	with circuit-breaker in the closed position		
	- between all live parts of all poles connected together and the frame of the circuit-breaker .	Compliance	P
	- between each pole and all the other poles connected to the frame of the circuit-breaker	Compliance	P
2)	with the circuit-breaker in the open position and, additionally, in the tripped position, if any.		
	- between all live parts of all poles connected together and the frame of the circuit-breaker.	Compliance	P

TRF No. IEC60947\_2F

*[Handwritten signature]*

**ВЯРНО С ОРИГИНАЛА**

*[Circular stamp: БИР 23 ЕОС]*

*[Handwritten number: 780]*

(

(

IEC 60947-2			
Clause	Requirement + Test	Result - Remark	Verdict
	- between the terminals of one side connected together and the terminals of the other side connected together.	Compliance	P
b)	Control and auxiliary circuits		
1)	- between all the control and auxiliary circuits which are not normally connected to the main circuit, connected together, and the frame of the circuit-breaker.	-	N/A
2)	- where appropriate, between each part of the control an auxiliary circuits which may be isolated from the other parts during normal operation and all the other parts connected together.	-	N/A
	No unintentional disruptive discharge during the tests	Compliance	P
8.3.3.2	For circuit-breaker suitable for isolation, the leakage current shall be measured through each pole with the contacts in the open position, at a test voltage of 1,1 Ue, and shall not exceed 0,5mA.	≤ 0,01 mA./ 759 V	P
8.3.3.3	Mechanical operation and operational performance capability		
8.3.3.3.2	Construction and mechanical operation		
a)	Construction		
	A withdrawable circuit-breaker shall be checked for the requirements stated in 7.1.1	-	N/A
	A circuit-breaker with stored energy operation shall be checked for compliance with 7.2.1.1.5, regarding the charge indicator and the direction of operation of manual energy storing	-	N/A
b)	Mechanical operation		
	A circuit-breaker with dependent power operation shall comply with the requirements stated in 7.2.1.1.3	-	N/A
	A circuit-breaker with dependent power operation shall operate with the operating mechanism charged to the minimum and maximum limits stated by the manufacturer	-	N/A
	A circuit-breaker with stored energy operation shall comply with the requirements stated in 7.2.1.5 with the auxiliary supply voltage at 85% and 110% of the rated control supply voltage.	-	N/A
	It shall also be verified that the moving contacts cannot be moved from the open position when the operating mechanism is charged to slightly below the full charge as evidenced by the indicating device	-	N/A

TRF No: IEC60947-2F

ВЯРНО С  
ОРИГИНАЛА

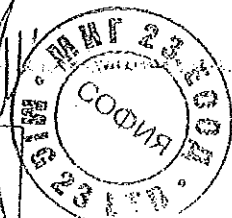

751

(

(



IEC 60947-2			
Clause	Requirement + Test	Result - Remark	Verdict
	For a trip-free circuit-breaker it shall not be possible to maintain the contacts in the touching or closed position when the tripping release is in the position to trip the circuit-breaker	-	N/A
	If the closing and opening times of a circuit-breaker are stated by the manufacturer, such times shall comply with the stated values	-	N/A
c)	Undervoltage releases		
	Undervoltage releases shall comply with the requirements of 7.2.1.3 of Part 1. For this purpose, the release shall be fitted to a circuit-breaker having the maximum current rating for which the release is suitable	-	N/A
i)	Drop out voltage		
	It shall be verified that the release operates to open the circuit-breaker between the voltage limits specified	-	N/A
	The voltage shall be reduced from rated voltage at a rate to reach 0 V in approximately 30 s	-	N/A
	The test for the lower limit is made without current in the main circuit and without previous heating of the release coil	-	N/A
	In the case of a release with a range of rated voltages, this test applies to the maximum voltage of the range	-	N/A
	The test for the upper limit is made starting from a constant temperature corresponding to the application of rated control supply voltage to the release and rated current in the main poles of the circuit-breaker	-	N/A
	This test may be combined with the temperature-rise test of 8.3.3.6	-	N/A
	In the case of a release with a range of rated voltages, this test is made at both the minimum and maximum rated control supply voltages	-	N/A
ii)	Test for limits of operation		
	Starting with the circuit-breaker open, at the temperature of the test room, and with the supply voltage at 30% rated maximum control supply voltage, it shall be verified that the circuit-breaker cannot be closed by the operation of the actuator	-	N/A
	When the supply voltage is raised to 85% of the minimum control supply voltage, it shall be verified that the circuit-breaker can be closed by the operation of the actuator	-	N/A

(

(

IEC 60947-2			
Clause	Requirement + Test	Result - Remark	Verdict
iii)	Performance under overvoltage conditions		
	With the circuit-breaker closed and without current in the main circuit, it shall be verified that the undervoltage release will withstand the application of 110% rated control supply voltage for 4 h without impairing its functions	-	N/A
d)	Shunt releases		
	Shunt releases shall comply with the requirements of 7.2.1.4 of Part 1. For this purpose, the release shall be fitted to a circuit-breaker having the maximum rated current for which the release is suitable	-	N/A
	It shall be verified that the release will operate to open the circuit-breaker at 70% rated control supply voltage when tested at an ambient temperature of + 55 °C ± 2 °C without current in the main poles of the circuit-breaker	-	N/A
	In the case of a release having a range of rated control supply voltages, the test voltage shall be 70% of the minimum rated control supply voltage	-	N/A
8.3.3.3.3	Operational performance capability without current.		
	Type designation or serial number	TS1600H 4P	
	Sample no:	S1-1	
	Rated current I <sub>n</sub> (A)	1600 A	
	Rated operational voltage: U <sub>e</sub> (V)	690 V	
	Rated control supply voltage of closing mechanism: U <sub>c</sub> (V)		
	Rated control supply voltage of shunt releases: U <sub>c</sub> (V)		
	Rated control supply voltage undervoltage releases: U <sub>c</sub> (V)		
	Ambient temperature 10-40 °C :	25 °C	P
	Number of operating cycles per hour	20 Cycles per hour	P
	Number of cycles without current (total) (closing mechanism energized at the rated U <sub>c</sub> )	-	N/A
	Number of cycles without current (without releases)	2500 Cycles	P
	Applied voltage: closing mechanism (V)	-	N/A
	10% of total cycles for circuit-breaker with fitted shunt release: (50% at the beginning- and 50% at the end of the test.) Energized at the rated U <sub>c</sub>	-	N/A

TRF No. IEC60947\_2F

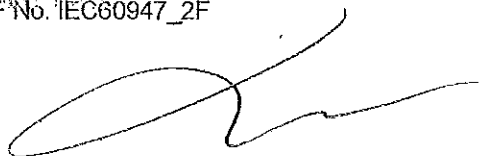
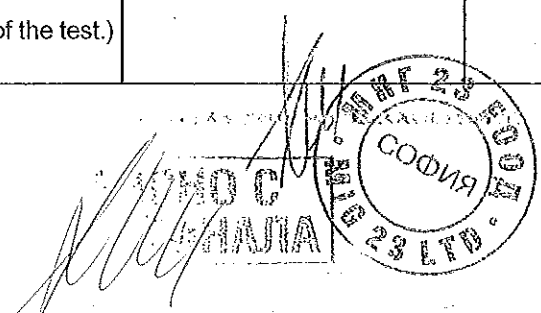
753

(

(

IEC 60947-2			
Clause	Requirement + Test	Result - Remark	Verdict
	Applied voltage: shunt releases (V)	-	N/A
	10% of total cycles for circuit-breaker with undervoltage releases: (50% at the beginning- and 50% at the end of the test.) Energized at the minimum rated Uc	-	N/A
	10 cycles without applied voltage at the undervoltage releases. (Shall not possible to close the circuit-breaker.)	-	N/A
	Applied voltage: undervoltage releases (V)	-	N/A
	Electrical components do not exceed the value indicated in tab. 7.	Compliance	P
8.3.3.3.4	Operational performance capability with current.		
	Rated current: In (A)	1600 A	
	Maximum rated operational voltage: Ue (V)	690 V	
	Conductor cross-sectional area (mm <sup>2</sup> ) :	500 mm <sup>2</sup> X 2	P
	Number of operating cycles per hour	20 Cycles per hour	P
	Number of cycles with current (total) (closing mechanism energized at the rated Uc)	500 Cycles	P
	Applied voltage: closing mechanism (V)		P
	For circuit-breaker fitted with adjustable releases, test shall be made with the overload setting at maximum and short-circuit setting at minimum.	Compliance	P
	Conditions, make/break operations:		
	- test voltage U/Ue = 1,0 (V) .....	L1: 691,8 V L2: 700,8 V L3: 708,3 V	P
	- test current I/Ie = 1,0 (A) .....	L1: 1618 A L2: 1625 A L3: 1602 A	P
	- power factor/time constant:	0,73	P
	- frequency: (Hz)	60 Hz	P
	- on-time (ms):	1000 ms	P
	- off-time (s):	179 s	P
	Electrical components do not exceed the value indicated in tab. 7.	Compliance	P

TRF No. IEC60947\_2F

ВЕРНО СДЕЛАНО  
ОРИГИНАЛ

23.08.2017

757

(

(

IEC 60947-2			
Clause	Requirement + Test	Result - Remark	Verdict
8.3.3.3.5	Additional test of operational performance capability without current for withdrawable circuit-breaker.		
	Number of operations cycles : 100	-	N/A
	After test, the isolating contacts, withdrawable mechanism and interlocks shall be suitable for further service.	-	N/A
8.3.3.4	Overload performance		
	this test applies to circuit-breaker of rated current up to and including 630 A		
	Type designation or serial number		
	Sample no:		
	Rated current $I_n$ (A)		
	Rated operational voltage: $U_e$ (V)		
	Rated control supply voltage of closing mechanism: $U_c$ (V)		
	Rated control supply voltage of shunt releases: $U_c$ (V)		
	Rated control supply voltage undervoltage releases: $U_c$ (V)		
	Ambient temperature 10-40 °C :	-	N/A
	Number of operating cycles per hour	-	N/A
	Maximum rated operational voltage: $U_e$ (V)	-	N/A
	Number of operating cycles per hour	-	N/A
	Number of cycles with current (total) (closing mechanism energized at the rated $U_c$ )	-	N/A
	Applied voltage: closing mechanism (V)	-	N/A
	For circuit-breaker fitted with adjustable releases, test shall be made with the overload/short-circuit settings at maximum.	-	N/A
	Conditions, overload operations:		
	- test voltage $U/U_e = 1,05$ (V) ..... L1: ..... L2: ..... L3:	-	N/A
	- test current AC/DC: $I/I_e = 6,0/2,5$ (A) ..... L1: ..... L2: ..... L3:	-	N/A
	- power factor/time constant:	-	N/A

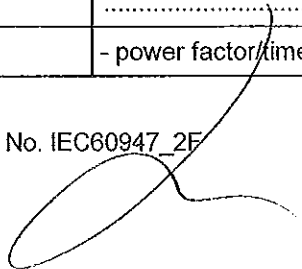
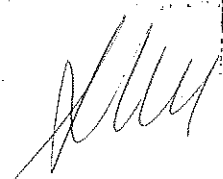
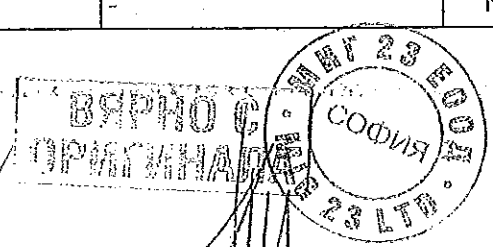
755

(

(



IEC 60947-2			
Clause	Requirement + Test	Result - Remark	Verdict
	- Number of cycles manually opened: 9	-	N/A
	- Number of cycles automatically opened by an overload release: 3	-	N/A
	- frequency: (Hz)	-	N/A
	- on-time max 2s:	-	N/A
8.3.3.5	Verification of dielectric withstand		
	- equal to twice the rated operational voltage with a minimum of 1000 V for 5 seconds	1380 V	P
	- no breakdown or flashover	No	P
	For circuit-breaker suitable for isolation, the leakage current shall be measured through each pole with the contacts in the open position, at a test voltage of 1,1 Ue, and shall not exceed 2 mA.	≤ 0,02 mA / 759 V	P
8.3.3.6	Verification of temperature-rise		
****	- the values of temperature-rise do not exceed those specified in tab. 7.	See table S1-1 (4P)	P
	Temperature rise of main circuit terminals ≤ 80 K (K) :	≤ 69,1 K	P
	conductor cross-sectional area (mm²) :	500 mm² x 2	P
	test current Ie (A) :	1600 A	P
8.3.3.7	Verification of overload releases		
	Test current: 1.45 times the value of their current setting at the reference temperature: (A)	2320 A	P
	Conventional tripping time: <1h when In < 63A, <2h when In > 63 A	540 s	P
8.3.3.8	Verification of undervoltage and shunt releases		
	Circuit-breaker fitted with undervoltage releases. The release shall not operate at 70% of the minimum control supply voltage -	-	N/A
	and shall operate at 35% of the maximum control supply voltage.	-	N/A
	Circuit-breaker fitted with shunt releases. The release shall operate at 70% of the minimum rated control supply voltage. Test made at room temperature.	-	N/A
8.3.3.9	Verification of the main contact position for circuit-breakers for isolation		
	actuating force for opening (N) .....	216 N	—
	test force with blocked main contacts for 10 s (N) ..	648 N	—

TRF No. IEC60947-2F



788

IEC 60947-2			
Clause	Requirement + Test	Result - Remark	Verdict
	Dependent power operation	-	N/A
	Supply voltage of 110% of rated voltage (V).....:	-	N/A
	Three attempts of 5 s to operate the equipment at intervals of 5 min.	-	N/A
	Independent power operation	-	N/A
	Three attempts to operate the equipment by the stored energy.	-	N/A
	Lock ability of driving mechanism in OFF-position at test force and blocked main contacts .....	-	N/A
	Position indicator does not show OFF-position after capture of test force at blocked main contacts	Compliance	P

TRF No. IEC60947\_2F

ВЕРНО С  
ОРИГИНАЛА

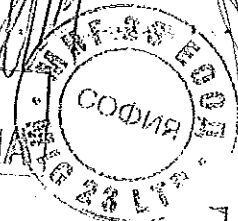

758

IEC 60947-2			
Clause	Requirement + Test	Result - Remark	Verdict

8.3.4	TEST SEQUENCE II (Ics):		
8.3.4.1	Test of rated service short-circuit breaking capacity		
	Test sequence of operation: O – t – CO – t – CO		
	Type designation or serial number	TS1600H 3P	
	Sample no:	S2-1 Rev	
	Rated current: In (A)	1600 A	
	Rated operational voltage: Ue (V)	240 V	
	Rated service short-circuit breaking capacity: (kA)	57 kA	
	Rated control supply voltage of closing mechanism: Uc (V)		
	Rated control supply voltage of shunt release: Uc (V)		
	For circuit-breaker fitted with adjustable releases, test shall be made with the current and time settings at maximum.	Compliance	P
	closing mechanism energized with 85% at the rated Uc: (V)	-	N/A
	The circuit-breaker is mounted complete on its own support or an equivalent support.	Compliance	P
	Test made in free air:	Compliance	P
	Distances of the metallic screen's: (all sides)	Side : 73.5 mm, Front : 0 mm Top bottom : no screen	P
	The characteristics of the metallic screen:		
	- woven wire mesh	-	N/A
	- perforated metal	Compliance	P
	- expanded metal	-	N/A
	- ratio hole area/total area: 0,45-0,65	0,5	P
	- size of hole: <30mm <sup>2</sup>	<30mm <sup>2</sup>	P
	- finish: bare or conductive plating	Compliance	P
	Test made in specified individual enclosure: Details of these tests, including the dimensions of the enclosure:	-	N/A
	Fuse "F": copper wire: diameter 0,8 mm, 50 mm long	Compliance	P

TRF No. IEC60947\_2F

ВЯРНО С  
ОПРИЗНАНА

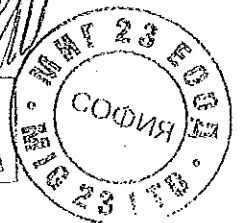

758

IEC 60947-2			
Clause	Requirement + Test	Result - Remark	Verdict
	Circuit is earthed at: (load-star- or supply-star point)	Load-star point	P
	Conductor cross-sectional area (mm <sup>2</sup> ) :	2CX50X10 mm <sup>2</sup>	P
	If terminals unmarked: line connected at: (underside/upside)	-	N/A
	Tightening torques: (Nm)	50 Nm	P
	Test sequence of operation: O - t - CO - t - CO	Compliance	P
	- test voltage U/Ue = 1,05 (V) ..... L1: ..... L2: ..... L3:	L1: 253,6 V L2: 253,0 V L3: 254,1 V	P
	- r.m.s. test current AC/DC: (A)..... L1: ..... L2: ..... L3:	L1: 57,7 kA L2: 57,6 kA L3: 57,5 kA	P
	power factor/time constant :	0,2	P
	- Factor "n"	2,27	P
	- peak test current (A) :	131,1 kA	P
	Test sequence "O"		
	- max. let-through current: (kA <sub>peak</sub> ) ..... L1: ..... L2: ..... L3:	L1: 121,5 kA L2: 93,1 kA L3: 87,0 kA	P
	- Joule integral I <sup>2</sup> dt (A <sup>2</sup> s) ..... L1: ..... L2: ..... L3:	L1: 70,1 MA <sup>2</sup> s L2: 43,0 MA <sup>2</sup> s L3: 31,8 MA <sup>2</sup> s	P
	Pause, t: (min)	3	P
	Test sequence "CO"		
	- max. let-through current: (kA <sub>peak</sub> ) ..... L1: ..... L2: ..... L3:	L1: 67,5 kA L2: 105,0 kA L3: 116,7 kA	P
	- Joule integral I <sup>2</sup> dt (A <sup>2</sup> s) ..... L1: ..... L2: ..... L3:	L1: 28,6 MA <sup>2</sup> s L2: 49,3 MA <sup>2</sup> s L3: 57,0 MA <sup>2</sup> s	P
	Pause, t: (min)	3	P
	Test sequence "CO"		
	- max. let-through current: (kA <sub>peak</sub> ) ..... L1: ..... L2: ..... L3:	L1: 100,8 kA L2: 80,6 kA L3: 115,1 kA	P

TRF №: IEC60947\_2F

ВЯРНО С  
ОРИГИНАЛА

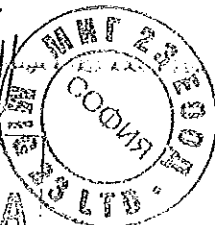

759

IEC 60947-2			
Clause	Requirement + Test	Result - Remark	Verdict
	- Joule integral I <sup>2</sup> dt (A <sup>2</sup> s) ..... L1: ..... L2: ..... L3:	L1: 51,9 MA <sup>2</sup> s L2: 30,9 MA <sup>2</sup> s L3: 64,1 MA <sup>2</sup> s	P
	Melting of the fusible element	Compliance	P
	Holes in the PE-sheet for test sequence "O"	-	N/A
	Cracks observed	Compliance	P
8.3.4.2	Operational performance capability with current.		
	Rated current: I <sub>n</sub> (A)	1600 A	
	Maximum rated operational voltage: U <sub>e</sub> (V)	240 V	
	Conductor cross-sectional area (mm <sup>2</sup> ):	500 mm <sup>2</sup> X 2	
	Number of operating cycles per hour	20 Cycles per hour	P
	Number (5% of the number given in column 4, tab. 8) of cycles with current (total) (closing mechanism energized at the rated U <sub>c</sub> )	25 Cycles	P
	Applied voltage: closing mechanism (V)	-	N/A
	For circuit-breaker fitted with adjustable releases, test shall be made with the overload setting at maximum and short-circuit setting at minimum.	Compliance	P
	Conditions, make/break operations:		
	- test voltage U/U <sub>e</sub> = 1,0 (V) ..... L1: ..... L2: ..... L3:	L1: 243,5 V L2: 250,5 V L3: 251,5 V	P
	- test current I/I <sub>e</sub> = 1,0 (A) ..... L1: ..... L2: ..... L3:	L1: 1604 A L2: 1618 A L3: 1606 A	P
	- power factor/time constant:	0,71	P
	- frequency: (Hz)	60 Hz	P
	- on-time (ms):	1000 ms	P
	- off-time (s):	179 s	P
8.3.4.3	Verification of dielectric withstand		
	- equal to twice the rated operational voltage with a minimum of 1000 V	1000 V	P
	- no breakdown or flashover	No	P
	- the leaking current for circuit-breaker suitable for isolation: (<2mA / 1.1 U <sub>e</sub> )	≤ 1,14 mA / 264 V	P

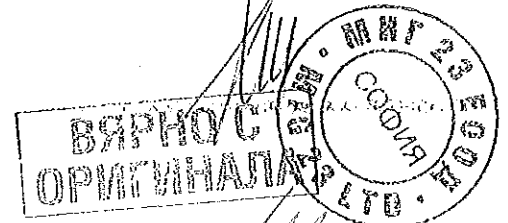

IEC 60947-2			
Clause	Requirement + Test	Result - Remark	Verdict
8.3.4.4	Verification of temperature-rise		
	- the values of temperature-rise do not exceed those specified in tab. 7.	See table S2-1R (3P)	B
	Temperature rise of main circuit terminals. ≤ 80 K (K) :	≤ 75,3 K	P
	conductor cross-sectional area (mm <sup>2</sup> ) :	500 mm <sup>2</sup> x 2	P
	test current I <sub>e</sub> (A) :	1600 A	P
8.3.4.5	Verification of overload releases		
	Test current: 1.45 times the value of their current setting at the reference temperature: (A)	2320 A	P
	Conventional tripping time: <1h when I <sub>n</sub> < 63A, <2h when I <sub>n</sub> > 63 A	535 s	P

8.3.4	TEST SEQUENCE II (Ics):		
8.3.4.1	Test of rated service short-circuit breaking capacity		
	Test sequence of operation: O – t – CO – t – CO		
	Type designation or serial number	TS1600H 3P	
	Sample no:	S2-2	
	Rated current: I <sub>n</sub> (A)	630 A	
	Rated operational voltage: U <sub>e</sub> (V)	240 V	
	Rated service short-circuit breaking capacity: (kA)	57 kA	
	Rated control supply voltage of closing mechanism: U <sub>c</sub> (V)		
	Rated control supply voltage of shunt release: U <sub>c</sub> (V)		
	For circuit-breaker fitted with adjustable releases, test shall be made with the current and time settings at maximum.	Compliance	P
	closing mechanism energized with 85% at the rated U <sub>c</sub> (V)	-	N/A
	The circuit-breaker is mounted complete on its own support or an equivalent support.	Compliance	P
	Test made in free air:	Compliance	P
	Distances of the metallic screen's: (all sides)	Side : 73.5 mm, Front: 0 mm Top bottom : no screen	P

TRF No. IEC60947\_2F

ВЯРНО С  
ОРИГИНАЛА

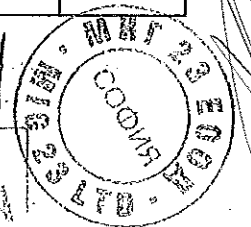

761

IEC 60947-2			
Clause	Requirement + Test	Result - Remark	Verdict
	The characteristics of the metallic screen:		
	- woven wire mesh	-	N/A
	- perforated metal	Compliance	P
	- expanded metal	-	N/A
	- ratio hole area/total area: 0,45-0,65	0,5	P
	- size of hole: <30mm <sup>2</sup>	< 30mm <sup>2</sup>	P
	- finish: bare or conductive plating	Compliance	P
	Test made in specified individual enclosure: Details of these tests, including the dimensions of the enclosure:	-	N/A
	Fuse "F": copper wire: diameter 0,8 mm, 50 mm long	Compliance	P
	Circuit is earthed at: (load-star- or supply-star point)	Load-star point	P
	Conductor cross-sectional area (mm <sup>2</sup> ) :	2CX40X5 mm <sup>2</sup>	P
	If terminals unmarked: line connected at: (underside/upside)	-	N/A
	Tightening torques: (Nm)	50 Nm	P
	Test sequence of operation: O – t – CO – t – CO	Compliance	P
	- test voltage U/U <sub>e</sub> = 1,05 (V) ..... L1: ..... L2: ..... L3:	L1: 253,7 V L2: 252,8 V L3: 254,0 V	P
	- r.m.s. test current AC/DC: (A)..... L1: ..... L2: ..... L3:	L1: 57,7 kA L2: 57,6 kA L3: 57,5 kA	P
	power factor/time constant :	0,20	P
	- Factor "n"	2,27	P
	- peak test current (A) :	131,1 kA	P
	Test sequence "O"		
	- max. let-through current: (kA <sub>peak</sub> ) ..... L1: ..... L2: ..... L3:	L1: 123,2 kA L2: 93,1 kA L3: 91,3 kA	P
	- Joule integral I <sup>2</sup> dt (A <sup>2</sup> s) ..... L1: ..... L2: ..... L3:	L1: 73,9 MA <sup>2</sup> s L2: 44,6 MA <sup>2</sup> s L3: 36,2 MA <sup>2</sup> s	P
	Pause, t: (min)	4	P

TRF No. IEC60947-2F

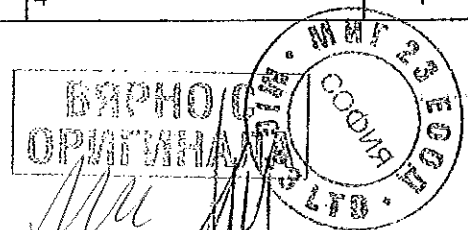

702

IEC 60947-2			
Clause	Requirement + Test	Result - Remark	Verdict
	Test sequence "CO"		
	- max. let-through current: (kA <sub>peak</sub> ) ..... L1: ..... L2: ..... L3:	L1: 75,1 kA L2: 110,2 kA L3: 111,4 kA	P
	- Joule integral I <sup>2</sup> dt (A <sup>2</sup> s) ..... L1: ..... L2: ..... L3:	L1: 32,8 MA <sup>2</sup> s L2: 59,6 MA <sup>2</sup> s L3: 65,0 MA <sup>2</sup> s	P
	Pause, t: (min)	3	P
	Test sequence "CO"		
	- max. let-through current: (kA <sub>peak</sub> ) ..... L1: ..... L2: ..... L3:	L1: 112,4 kA L2: 78,2 kA L3: 97,5 kA	P
	- Joule integral I <sup>2</sup> dt (A <sup>2</sup> s) ..... L1: ..... L2: ..... L3:	L1: 66,4 MA <sup>2</sup> s L2: 38,0 MA <sup>2</sup> s L3: 43,7 MA <sup>2</sup> s	P
	Melting of the fusible element	Compliance	P
	Holes in the PE-sheet for test sequence "O"	-	N/A
	Cracks observed	Compliance	P
8.3.4.2	Operational performance capability with current.		
	Rated current: I <sub>n</sub> (A)		
	Maximum rated operational voltage: U <sub>e</sub> (V)		
	Conductor cross-sectional area (mm <sup>2</sup> ):		
	Number of operating cycles per hour	-	N/A
	Number (5% of the number given in column 4, tab. 8) of cycles with current (total) (closing mechanism energized at the rated U <sub>c</sub> )	-	N/A
	Applied voltage: closing mechanism (V)	-	N/A
	For circuit-breaker fitted with adjustable releases, test shall be made with the overload setting at maximum and short-circuit setting at minimum.	-	N/A
	Conditions, make/break operations:		
	- test voltage U/U <sub>e</sub> = 1,0 (V) ..... L1: ..... L2: ..... L3:	-	N/A
	- test current I/I <sub>e</sub> = 1,0 (A) ..... L1: ..... L2: ..... L3:	-	N/A

TRF No. IEC60947-2F

ВЯРНО С  
ОРИГИНАЛ

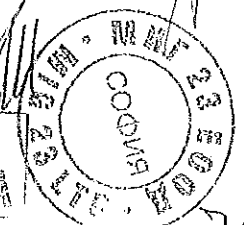

783



IEC 60947-2			
Clause	Requirement + Test	Result - Remark	Verdict
	- power factor/time constant:	-	N/A
	- frequency: (Hz)	-	N/A
	- on-time (ms):	-	N/A
	- off-time (s):	-	N/A
8.3.4.3	Verification of dielectric withstand		
	- equal to twice the rated operational voltage with a minimum of 1000 V	1000 V	P
	- no breakdown or flashover	No	P
	- the leaking current for circuit-breaker suitable for isolation: (<2mA / 1.1 Ue)	≤ 0,77 mA / 264 V	P
8.3.4.4	Verification of temperature-rise		
	- the values of temperature-rise do not exceed those specified in tab. 7.	-	N/A
	Temperature rise of main circuit terminals. ≤ 80 K (K) :	-	N/A
	conductor cross-sectional area (mm <sup>2</sup> ) :	-	N/A
	test current Ie (A) :	-	N/A
8.3.4.5	Verification of overload releases		
	Test current: 1.45 times the value of their current setting at the reference temperature: (A)	913,5 A	P
	Conventional tripping time: <1h when In < 63A, <2h when In > 63 A	517 s	P

8.3.4	TEST SEQUENCE II (Ics):		
8.3.4.1	Test of rated service short-circuit breaking capacity		
	Test sequence of operation: O – t – CO – t – CO		
	Type designation or serial number	TS1600H 3P	
	Sample no:	S2-3	
	Rated current: In (A)	1600 A	
	Rated operational voltage: Ue (V)	460 V	
	Rated service short-circuit breaking capacity: (kA)	50 kA	
	Rated control supply voltage of closing mechanism: Uc (V)		
	Rated control supply voltage of shunt release: Uc (V)		

TRF No. IEC60947\_2E

ВРНО С  
ОПРИБАНА

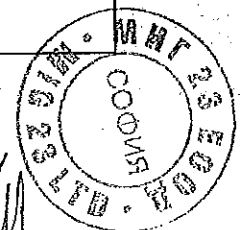

IEC 60947-2			
Clause	Requirement + Test	Result - Remark	Verdict
	For circuit-breaker fitted with adjustable releases, test shall be made with the current and time settings at maximum.	Compliance	P
	closing mechanism energized with 85% at the rated Uc: (V)	-	N/A
	The circuit-breaker is mounted complete on its own support or an equivalent support.	Compliance	P
	Test made in free air:	Compliance	P
	Distances of the metallic screen's: (all sides)	Side : 73.5 mm, Front : 0 mm Top bottom : no screen	P
	The characteristics of the metallic screen:		
	- woven wire mesh	-	N/A
	- perforated metal	Compliance	P
	- expanded metal	-	N/A
	- ratio hole area/total area: 0,45-0,65	0,5	P
	- size of hole: <30mm <sup>2</sup>	< 30mm <sup>2</sup>	P
	- finish: bare or conductive plating	Compliance	P
	Test made in specified individual enclosure: Details of these tests, including the dimensions of the enclosure:	-	N/A
	Fuse "F": copper wire: diameter 0,8 mm, 50 mm long	Compliance	P
	Circuit is earthed at: (load-star- or supply-star point)	Load-star point	P
	Conductor cross-sectional area (mm <sup>2</sup> ) :	2CX50X10 mm <sup>2</sup>	P
	If terminals unmarked: line connected at: (underside/upside)	-	N/A
	Tightening torques: (Nm)	50 Nm	P
	Test sequence of operation: O – t – CO – t – CO	Compliance	P
	- test voltage U/Ue = 1,05 (V) ..... L1: ..... L2: ..... L3:	L1: 486,2 V L2: 488,7 V L3: 484,7 V	P
	- r.m.s. test current AC/DC: (A)..... L1: ..... L2: ..... L3:	L1: 50,9 kA L2: 50,3 kA L3: 50,5 kA	P
	power factor/time constant :	0,23	P
	- Factor "n"	2,17	P

TRF No. IEC60947 2F

ВЯРНО С  
ОРИГИНАЛА

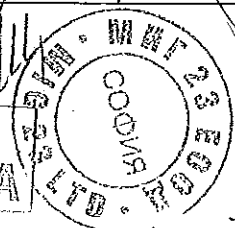

765

IEC 60947-2			
Clause	Requirement + Test	Result - Remark	Verdict
	- peak test current (A) :	110,9 kA	P
	Test sequence "O"		
	- max. let-through current: (kA <sub>peak</sub> ) ..... L1: ..... L2: ..... L3:	L1: 108,9 kA L2: 82,4 kA L3: 86,2 kA	P
	- Joule integral I <sup>2</sup> dt (A <sup>2</sup> s) ..... L1: ..... L2: ..... L3:	L1: 62,0 MA <sup>2</sup> s L2: 38,3 MA <sup>2</sup> s L3: 35,3 MA <sup>2</sup> s	P
	Pause, t: (min)	5	P
	Test sequence "CO"		
	- max. let-through current: (kA <sub>peak</sub> ) ..... L1: ..... L2: ..... L3:	L1: 86,5 kA L2: 83,1 kA L3: 106,8 kA	P
	- Joule integral I <sup>2</sup> dt (A <sup>2</sup> s) ..... L1: ..... L2: ..... L3:	L1: 45,8 MA <sup>2</sup> s L2: 37,9 MA <sup>2</sup> s L3: 64,3 MA <sup>2</sup> s	P
	Pause, t: (min)	3	P
	Test sequence "CO"		
	- max. let-through current: (kA <sub>peak</sub> ) ..... L1: ..... L2: ..... L3:	L1: 73,8 kA L2: 102,3 kA L3: 98,6 kA	P
	- Joule integral I <sup>2</sup> dt (A <sup>2</sup> s) ..... L1: ..... L2: ..... L3:	L1: 31,5 MA <sup>2</sup> s L2: 54,7 MA <sup>2</sup> s L3: 54,1 MA <sup>2</sup> s	P
	Melting of the fusible element	Compliance	P
	Holes in the PE-sheet for test sequence "O"	-	N/A
	Cracks observed	Compliance	P
8.3.4.2	Operational performance capability with current.		
	Rated current: I <sub>n</sub> (A)	1600 A	
	Maximum rated operational voltage: U <sub>e</sub> (V)	460 V	
	Conductor cross-sectional area (mm <sup>2</sup> ) :	500 mm <sup>2</sup> X 2	
	Number of operating cycles per hour	20 Cycles per hour	P
	Number (5% of the number given in column 4, tab. 8) of cycles with current (total) (closing mechanism energized at the rated U <sub>c</sub> )	25 Cycles	P
	Applied voltage: closing mechanism (V)	-	N/A

TRF No. IEC60947\_2F

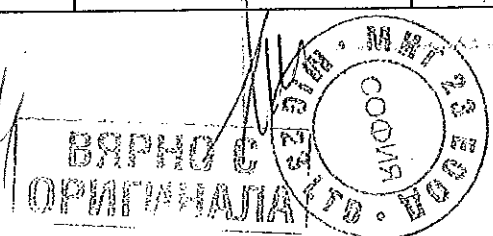

788

IEC 60947-2			
Clause	Requirement + Test	Result - Remark	Verdict
	For circuit-breaker fitted with adjustable releases, test shall be made with the overload setting at maximum and short-circuit setting at minimum.	-	N/A
	Conditions, make/break operations:		
	- test voltage $U/U_e = 1,0$ (V) ..... L1: ..... L2: ..... L3:	L1: 472,0 V L2: 474,8 V L3: 476,8 V	P
	- test current $I/I_e = 1,0$ (A) ..... L1: ..... L2: ..... L3:	L1: 1600 A L2: 1622 A L3: 1610 A	P
	- power factor/time constant:	0,70	P
	- frequency: (Hz)	60 Hz	P
	- on-time (ms):	1000 ms	P
	- off-time (s):	179 s	P
8.3.4.3	Verification of dielectric withstand		
	- equal to twice the rated operational voltage with a minimum of 1000 V	1000 V	P
	- no breakdown or flashover	No	P
	- the leaking current for circuit-breaker suitable for isolation: ( $<2\text{mA} / 1.1 U_e$ )	$\leq 0,58 \text{ mA} / 506 \text{ V}$	P
8.3.4.4	Verification of temperature-rise		
	- the values of temperature-rise do not exceed those specified in tab. 7.	See table S2-3 (3P)	P
	Temperature rise of main circuit terminals. $\leq 80 \text{ K}$ (K) :	$\leq 78,4 \text{ K}$	P
	conductor cross-sectional area ( ) :	$500 \text{ mm}^2 \times 2$	P
	test current $I_e$ (A) :	1600 A	P
8.3.4.5	Verification of overload releases		
	Test current: 1.45 times the value of their current setting at the reference temperature: (A)	2320 A	P
	Conventional tripping time: $<1\text{h}$ when $I_n < 63\text{A}$ , $<2\text{h}$ when $I_n > 63 \text{ A}$	532 s	P

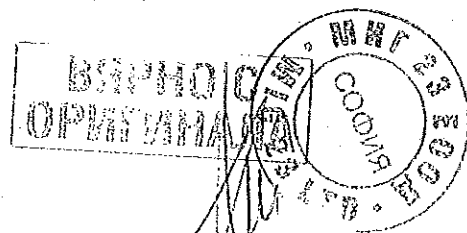

IEC 60947-2			
Clause	Requirement + Test	Result - Remark	Verdict
8.3.4	TEST SEQUENCE II (Ics):		
8.3.4.1	Test of rated service short-circuit breaking capacity		
	Test sequence of operation: O – t – CO – t – CO		
	Type designation or serial number	TS1600H 3P	
	Sample no:	S2-4 Rev	
	Rated current: In (A)	1600 A	
	Rated operational voltage: Ue (V)	690 V	
	Rated service short-circuit breaking capacity: (kA)	35 kA	
	Rated control supply voltage of closing mechanism: Uc (V)		
	Rated control supply voltage of shunt release: Uc (V)		
	For circuit-breaker fitted with adjustable releases, test shall be made with the current and time settings at maximum.	Compliance	P
	closing mechanism energized with 85% at the rated Uc: (V)	-	N/A
	The circuit-breaker is mounted complete on its own support or an equivalent support.	Compliance	P
	Test made in free air:	Compliance	P
	Distances of the metallic screen's: (all sides)	Side : 73.5 mm, Front : 0 mm Top bottom : no screen	P
	The characteristics of the metallic screen:		
	- woven wire mesh	-	N/A
	- perforated metal	Compliance	P
	- expanded metal	-	N/A
	- ratio hole area/total area: 0,45-0,65	0,5	P
	- size of hole: <30mm <sup>2</sup>	< 30mm <sup>2</sup>	P
	- finish: bare or conductive plating	Compliance	P
	Test made in specified individual enclosure: Details of these tests, including the dimensions of the enclosure:	-	N/A
	Fuse "F": copper wire: diameter 0,8 mm, 50 mm long	Compliance	P
	Circuit is earthed at: (load-star- or supply-star point)	Load-star point	P

TRF-No. IEC60947\_2F

ВЕРНО С  
ОРИГИНАЛА

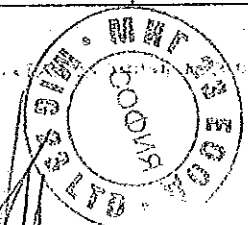

760

IEC 60947-2			
Clause	Requirement + Test	Result - Remark	Verdict
	Conductor cross-sectional area (mm <sup>2</sup> ) :	2CX50X10 mm <sup>2</sup>	P
	If terminals unmarked: line connected at: (underside/upside)	-	N/A
	Tightening torques: (Nm)	50 Nm	P
	Test sequence of operation: O – t – CO – t – CO	Compliance	P
	- test voltage U/Ue = 1,05 (V) ..... L1: ..... L2: ..... L3:	L1: 734,9 V L2: 735,7 V L3: 733,0 V	P
	- r.m.s. test current AC/DC: (A)..... L1: ..... L2: ..... L3:	L1: 35,1 kA L2: 35,0 kA L3: 35,1 kA	P
	power factor/time constant :	0,24	P
	- Factor "n"	2,17	P
	- peak test current (A) :	76,3 kA	P
	Test sequence "O"		
	- max. let-through current: (kA <sub>peak</sub> ) ..... L1: ..... L2: ..... L3:	L1: 74,5 kA L2: 58,3 kA L3: 63,2 kA	P
	- Joule integral I <sup>2</sup> dt (A <sup>2</sup> s) ..... L1: ..... L2: ..... L3:	L1: 31,5 MA <sup>2</sup> s L2: 21,6 MA <sup>2</sup> s L3: 20,4 MA <sup>2</sup> s	P
	Pause, t: (min)	5	P
	Test sequence "CO"		
	- max. let-through current: (kA <sub>peak</sub> ) ..... L1: ..... L2: ..... L3:	L1: 56,9 kA L2: 74,7 kA L3: 65,9 kA	P
	- Joule integral I <sup>2</sup> dt (A <sup>2</sup> s) ..... L1: ..... L2: ..... L3:	L1: 17,9 MA <sup>2</sup> s L2: 30,9 MA <sup>2</sup> s L3: 24,7 MA <sup>2</sup> s	P
	Pause, t: (min)	3	P
	Test sequence "CO"		
	- max. let-through current: (kA <sub>peak</sub> ) ..... L1: ..... L2: ..... L3:	L1: 62,8 kA L2: 59,0 kA L3: 74,5 kA	P

IEC 60947-2			
Clause	Requirement + Test	Result - Remark	Verdict
	- Joule integral $I^2dt$ (A <sup>2</sup> s) ..... L1: ..... L2: ..... L3:	L1: 25,2 MA <sup>2</sup> s L2: 20,3 MA <sup>2</sup> s L3: 32,0 MA <sup>2</sup> s	P
	Melting of the fusible element	Compliance	P
	Holes in the PE-sheet for test sequence "O"	-	N/A
	Cracks observed	Compliance	P
8.3.4.2	Operational performance capability with current.		
	Rated current: In (A)	1600 A	
	Maximum rated operational voltage: Ue (V)	690 V	
	Conductor cross-sectional area (mm <sup>2</sup> ):	500 mm <sup>2</sup> X 2	
	Number of operating cycles per hour	20 Cycles per hour	P
	Number (5% of the number given in column 4, tab. 8) of cycles with current (total) (closing mechanism energized at the rated Ue)	25 Cycles	P
	Applied voltage: closing mechanism (V)	-	N/A
	For circuit-breaker fitted with adjustable releases, test shall be made with the overload setting at maximum and short-circuit setting at minimum.	-	N/A
	Conditions, make/break operations:		
	- test voltage $U/U_e = 1,0$ (V) ..... L1: ..... L2: ..... L3:	L1: 716,5 V L2: 719,8 V L3: 716,0 V	P
	- test current $I/I_e = 1,0$ (A) ..... L1: ..... L2: ..... L3:	L1: 1622 A L2: 1622 A L3: 1624 A	P
	- power factor/time constant:	0,73	P
	- frequency: (Hz)	60 Hz	P
	- on-time (ms):	1000 ms	P
	- off-time (s):	179 s	P
8.3.4.3	Verification of dielectric withstand		
	- equal to twice the rated operational voltage with a minimum of 1000 V	1380 V	P
	- no breakdown or flashover	No	P
	- the leaking current for circuit-breaker suitable for isolation: (<2mA / 1:1 Ue)	≤0,07 mA / 759 V	P

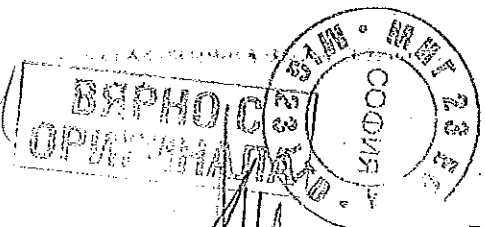

IEC 60947-2			
Clause	Requirement + Test	Result - Remark	Verdict
8.3.4.4	Verification of temperature-rise		
	- the values of temperature-rise do not exceed those specified in tab. 7.	See table S2-4R (3P)	
	Temperature rise of main circuit terminals. ≤ 80 K (K) :	≤ 78,9 K	P
	conductor cross-sectional area (mm <sup>2</sup> ) :	500 mm <sup>2</sup> x 2	P
	test current I <sub>e</sub> (A) :	1600 A	P
8.3.4.5	Verification of overload releases		
	Test current: 1.45 times the value of their current setting at the reference temperature: (A)	2320 A	P
	Conventional tripping time: <1h when I <sub>n</sub> < 63A, <2h when I <sub>n</sub> > 63 A	537 s	P

8.3.4	TEST SEQUENCE II/III (I <sub>cs</sub> =I <sub>cu</sub> ):	N/A
-------	---	-----

8.3.5	TEST SEQUENCE III (I <sub>cu</sub> )	
	Rated ultimate short-circuit breaking	
	Except where the combined test sequence applies, this test sequence applies to circuit-breaker of utilization category A and to circuit-breaker of utilization B having a rated ultimate short-circuit breaking capacity higher than the rated short-time withstand current.	
	For circuit-breakers of utilization B having a rated short-time withstand current equal to their rated ultimate short-circuit breaking capacity, this test sequence need not be made, since, in this case, the ultimate short-circuit breaking capacity, is verified when carrying out test sequence IV.	
	For integrally fused circuit-breakers, test sequence V applies in place of this sequence.	
	Type designation or serial number	TS1600H 3P
	Sample no:	S3-1
	Rated current: I <sub>n</sub> (A)	1600 A
	Rated operational voltage: U <sub>e</sub> (V)	240 V
	Rated ultimate short-circuit breaking capacity: (kA)	75 kA
	Rated control supply voltage of closing mechanism: U <sub>c</sub> (V)	

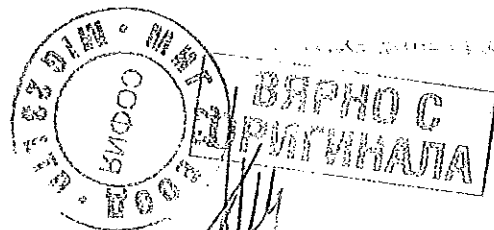

Handwritten signature and the number 771.



IEC 60947-2			
Clause	Requirement + Test	Result - Remark	Verdict
	Rated control supply voltage of shunt release: Uc (V)		
	This test sequence need not be made when Icu = Ics		
8.3.5.1	The operation of overload releases shall be verified at twice the value of their current setting on each pole separately.		
	The operating time shall not exceed the max. value stated by the manufacturer for twice the current setting at the reference temperature, on a pole singly.		
	Time specified by the manufacturer:	152~317 s	P
	- Operation time: (s) ..... L1:	216 s	P
	..... L2:	204 s	
	..... L3:	220 s	
	..... N :		
8.3.5.2	Test of rated ultimate short-circuit breaking capacity		
	The test sequence of operations is O – t – CO		
	For circuit-breaker fitted with adjustable releases, test shall be made with the current and time settings at maximum.	Compliance	P
	closing mechanism energized with 85% at the rated Uc: (V)	-	N/A
	The circuit-breaker is mounted complete on its own support or an equivalent support.	Compliance	P
	Test made in free air:	Compliance	P
	Distances of the metallic screen's: (all sides)	Side : 73.5 mm, Front : 0 mm Top bottom : no screen	P
	The characteristics of the metallic screen:		
	- woven wire mesh	-	N/A
	- perforated metal	Compliance	P
	- expanded metal	-	N/A
	- ratio hole area/total area: 0,45-0,65	0,5	P
	- size of hole: <30mm <sup>2</sup>	< 30mm <sup>2</sup>	P
	- finish: bare or conductive plating	Compliance	P
	Test made in specified individual enclosure: Details of these tests, including the dimensions of the enclosure:	-	N/A
	Fuse "F": copper wire: diameter 0,8 mm, 50 mm long	Compliance	P
	Circuit is earthed at: (load-star- or supply-star point)	Load-star point	P

TRF No. IEC60947\_2F

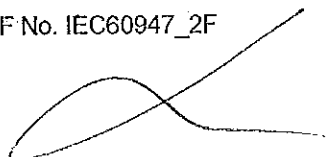
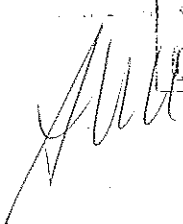

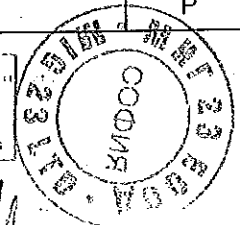

ВЕРНО  
ОПРЕДЕЛЕНА

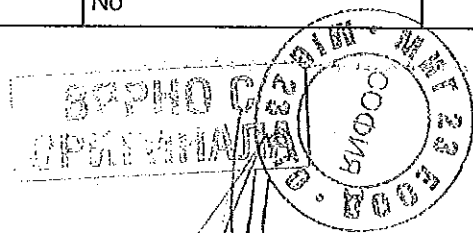

782

IEC 60947-2			
Clause	Requirement + Test	Result - Remark	Verdict
	Conductor cross-sectional area (mm <sup>2</sup> ) :	2CX50X10 mm <sup>2</sup>	P
	If terminals unmarked: line connected at: (underside/upside)	-	N/A
	Tightening, torques: (Nm)	50 Nm	P
	Test sequence of operation: O – t – CO	Compliance	P
	- test voltage U/Ue = 1,05 (V) ..... L1: ..... L2: ..... L3:	L1: 253,6 V L2: 253,6 V L3: 253,7 V	P
	- r.m.s. test current AC/DC: (A)..... L1: ..... L2: ..... L3:	L1: 75,9 kA L2: 76,3 kA L3: 74,8 kA	P
	power factor/time constant :	0,20	P
	- Factor "n"	2,27	P
	- peak test current (Amax) :	172,9 kA	
	Test sequence "O"		
	- max. let-through current: (kA <sub>peak</sub> ) ..... L1: ..... L2: ..... L3:	L1: 126,1 kA L2: 122,8 kA L3: 109,8 kA	P
	- Joule integral I <sup>2</sup> dt (A <sup>2</sup> s) ..... L1: ..... L2: ..... L3:	L1: 92,5 MA <sup>2</sup> s L2: 71,7 MA <sup>2</sup> s L3: 50,5 MA <sup>2</sup> s	P
	Pause, t (min)	4	P
	Test sequence "CO"		
	- max. let-through current: (kA <sub>peak</sub> ) ..... L1: ..... L2: ..... L3:	L1: 126,1 kA L2: 110,1 kA L3: 111,4 kA	P
	- Joule integral I <sup>2</sup> dt (A <sup>2</sup> s) ..... L1: ..... L2: ..... L3:	L1: 92,0 MA <sup>2</sup> s L2: 64,0 MA <sup>2</sup> s L3: 53,9 MA <sup>2</sup> s	P
	Melting of the fusible element	Compliance	P
	Holes in the PE-sheet for test sequence "O"	-	N/A
	Cracks observed	Compliance	P
8.3.5.3	Verification of dielectric withstand		
	- equal to twice the rated operational voltage with a minimum of 1000 V for 5 seconds	1000 V	P
	- no breakdown or flashover	No	P



IEC 60947-2			
Clause	Requirement + Test	Result - Remark	Verdict
	- the leaking current for circuit-breaker suitable for isolation: (<6mA / 1,1 Ue)	≤ 0,1 mA / 264 V	P
8.3.5.4	Verification of overload releases		
	The operation of overload releases shall be verified at 2,5 times the value of their current setting on each pole separately.		
	The operating time shall not exceed the max. value stated by the manufacturer for twice the current setting at the reference temperature, on a pole singly.		
	Time specified by the manufacturer:	92~182 s	P
	- Operation time: (s) ..... L1:	123 s	P
	..... L2:	122 s	
	..... L3:	129 s	
	..... N :		

8.3.5	TEST SEQUENCE III (Icu)		
	Rated ultimate short-circuit breaking		
	Except where the combined test sequence applies, this test sequence applies to circuit-breaker of utilization category A and to circuit-breaker of utilization B having a rated ultimate short-circuit breaking capacity higher than the rated short-time withstand current.		
	For circuit-breakers of utilization B having a rated short-time withstand current equal to their rated ultimate short-circuit breaking capacity, this test sequence need not be made, since, in this case, the ultimate short-circuit breaking capacity, is verified when carrying out test sequence IV.		
	For integrally fused circuit-breakers, test sequence V applies in place of this sequence.		
	Type designation or serial number	TS1600H 3P	
	Sample no:	S3-2	
	Rated current: In (A)	630 A	
	Rated operational voltage: Ue (V)	240 V	
	Rated ultimate short-circuit breaking capacity: (kA)	75 kA	
	Rated control supply voltage of closing mechanism: Uc (V)		
	Rated control supply voltage of shunt release: Uc (V)		

TRF No. IEC60947\_2F

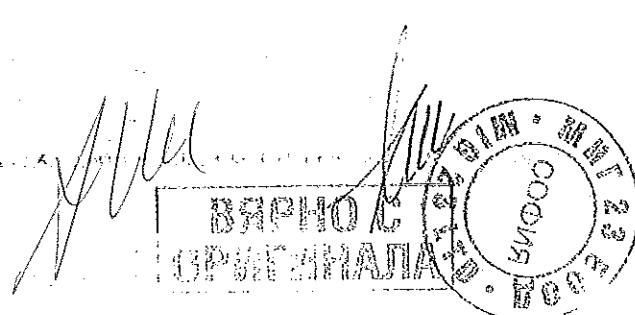

Official stamps and signatures are present at the bottom of the page, including a circular stamp with the text 'СЕРТИФИКАТ' and 'ОПРЕДЕЛЕНИЕ'.

277

IEC 60947-2			
Clause	Requirement + Test	Result - Remark	Verdict
	This test sequence need not be made when $I_{cu} = I_{cs}$		
8.3.5.1	The operation of overload releases shall be verified at twice the value of their current setting on each pole separately.		
	The operating time shall not exceed the max. value stated by the manufacturer for twice the current setting at the reference temperature, on a pole singly.		
	Time specified by the manufacturer:	152~317 s	P
	- Operation time: (s) ..... L1:	218 s	P
	..... L2:	212 s	
	..... L3:	214 s	
	..... N:		
8.3.5.2	Test of rated ultimate short-circuit breaking capacity		
	The test sequence of operations is O – t – CO		
	For circuit-breaker fitted with adjustable releases, test shall be made with the current and time settings at maximum.	Compliance	P
	closing mechanism energized with 85% at the rated $U_c$ : (V)	-	N/A
	The circuit-breaker is mounted complete on its own support or an equivalent support.	Compliance	P
	Test made in free air:	Compliance	P
	Distances of the metallic screen's: (all sides)	Side : 73.5 mm, Front : 0 mm Top bottom : no screen	P
	The characteristics of the metallic screen:		
	- woven wire mesh	-	N/A
	- perforated metal	Compliance	P
	- expanded metal	-	N/A
	- ratio hole area/total area: 0,45-0,65	0,5	P
	- size of hole: <30mm <sup>2</sup>	< 30mm <sup>2</sup>	P
	- finish: bare or conductive plating	Compliance	P
	Test made in specified individual enclosure: Details of these tests, including the dimensions of the enclosure:	-	N/A
	Fuse "F": copper wire: diameter 0,8 mm, 50 mm long	Compliance	P
	Circuit is earthed at: (load-star- or supply-star point)	Load-star point	P
	Conductor cross-sectional area (mm <sup>2</sup> ) :	2CX40X5 mm <sup>2</sup>	

TRF No. IEC60947\_2F



775

IEC 60947-2			
Clause	Requirement + Test	Result - Remark	Verdict
	If terminals unmarked: line connected at: (underside/upside)	-	N/A
	Tightening, torques: (Nm)	50 Nm	P
	Test sequence of operation: O – t – CO	Compliance	P
	- test voltage $U/U_e = 1,05$ (V) ..... L1: ..... L2: ..... L3:	L1: 253,8 V L2: 253,2 V L3: 254,1 V	P
	- r.m.s. test current AC/DC: (A)..... L1: ..... L2: ..... L3:	L1: 75,9 kA L2: 76,3 kA L3: 74,8 kA	P
	power factor/time constant :	0,20	P
	- Factor "n"	2,28	
	- peak test current (Amax) :	172,9 kA	
	Test sequence "O"		
	- max. let-through current: (kA <sub>peak</sub> ) ..... L1: ..... L2: ..... L3:	L1: 142,5 kA L2: 120,7 kA L3: 108,0 kA	P
	- Joule integral $I^2dt$ (A <sup>2</sup> s) ..... L1: ..... L2: ..... L3:	L1: 98,0 MA <sup>2</sup> s L2: 68,4 MA <sup>2</sup> s L3: 48,9 MA <sup>2</sup> s	P
	Pause, t: (min)	6	P
	Test sequence "CO"		
	- max. let-through current: (kA <sub>peak</sub> ) ..... L1: ..... L2: ..... L3:	L1: 133,3 kA L2: 89,6 kA L3: 127,9 kA	P
	- Joule integral $I^2dt$ (A <sup>2</sup> s) ..... L1: ..... L2: ..... L3:	L1: 85,3 MA <sup>2</sup> s L2: 46,1 MA <sup>2</sup> s L3: 75,1 MA <sup>2</sup> s	P
	Melting of the fusible element	Compliance	P
	Holes in the PE-sheet for test sequence "O"	-	N/A
	Cracks observed	Compliance	P
8.3.5.3	Verification of dielectric withstand		
	- equal to twice the rated operational voltage with a minimum of 1000 V for 5 seconds	1000 V	P
	- no breakdown or flashover	No	P

TRF No. IEC60947\_2F

ВЯРНО С  
ОРИГИНАЛА

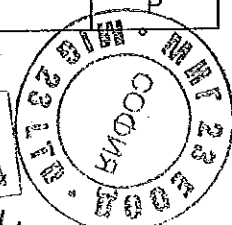

770

IEC 60947-2			
Clause	Requirement + Test	Result - Remark	Verdict
	- the leaking current for circuit-breaker suitable for isolation: (<6mA / 1,1 Ue)	≤ 1,31 mA / 264 V	P
8.3.5.4	Verification of overload releases		
	The operation of overload releases shall be verified at 2,5 times the value of their current setting on each pole separately.		
	The operating time shall not exceed the max. value stated by the manufacturer for twice the current setting at the reference temperature, on a pole singly.		
	Time specified by the manufacturer:	92~182 s	P
	- Operation time: (s) .....		P
	..... L1:	128 s	
	..... L2:	125 s	
	..... L3:	126 s	
	..... N :		

8.3.5	TEST SEQUENCE III (Icu)		
	Rated ultimate short-circuit breaking		
	Except where the combined test sequence applies, this test sequence applies to circuit-breaker of utilization category A and to circuit-breaker of utilization B having a rated ultimate short-circuit breaking capacity higher than the rated short-time withstand current.		
	For circuit-breakers of utilization B having a rated short-time withstand current equal to their rated ultimate short-circuit breaking capacity, this test sequence need not be made, since, in this case, the ultimate short-circuit breaking capacity, is verified when carrying out test sequence IV.		
	For integrally fused circuit-breakers, test sequence V applies in place of this sequence.		
	Type designation or serial number	TS1600H 3P	
	Sample no:	S3-3	
	Rated current: In (A)	1600 A	
	Rated operational voltage: Ue (V)	460 V	
	Rated ultimate short-circuit breaking capacity: (kA)	65 kA	
	Rated control supply voltage of closing mechanism: Uc (V)		
	Rated control supply voltage of shunt release: Uc (V)		

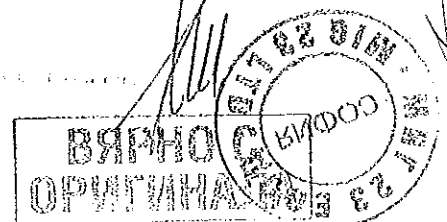

IEC 60947-2			
Clause	Requirement + Test	Result - Remark	Verdict
	This test sequence need not be made when Icu = Ics		
8.3.5.1	The operation of overload releases shall be verified at twice the value of their current setting on each pole separately.		
	The operating time shall not exceed the max. value stated by the manufacturer for twice the current setting at the reference temperature, on a pole singly.		
	Time specified by the manufacturer:	152~317 s	P
	- Operation time: (s) ..... L1:	211 s	P
	..... L2:	215 s	
	..... L3:	209 s	
	..... N :		
8.3.5.2	Test of rated ultimate short-circuit breaking capacity		
	The test sequence of operations is O – t – CO		
	For circuit-breaker fitted with adjustable releases, test shall be made with the current and time settings at maximum.	Compliance	P
	closing mechanism energized with 85% at the rated Uc: (V)	-	N/A
	The circuit-breaker is mounted complete on its own support or an equivalent support.	Compliance	P
	Test made in free air:	Compliance	P
	Distances of the metallic screen's: (all sides)	Side : 73.5 mm, Front : 0 mm Top bottom : no screen	P
	The characteristics of the metallic screen:		
	- woven wire mesh	-	N/A
	- perforated metal	Compliance	P
	- expanded metal	-	N/A
	- ratio hole area/total area: 0,45-0,65	0,5	P
	- size of hole: <30mm <sup>2</sup>	< 30mm <sup>2</sup>	P
	- finish: bare or conductive plating	Compliance	P
	Test made in specified individual enclosure: Details of these tests, including the dimensions of the enclosure:	-	N/A
	Fuse "F": copper wire: diameter 0,8 mm, 50 mm long	Compliance	P
	Circuit is earthed at: (load-star- or supply-star point)	Load-star point	P
	Conductor cross-sectional area (mm <sup>2</sup> ):	2CX50X10 mm <sup>2</sup>	P

TRF No. IEC60947\_2F

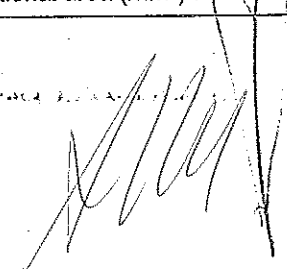

ВЕРНО С  
ОРИГИНАЛА



IEC 60947-2			
Clause	Requirement + Test	Result - Remark	Verdict
	If terminals unmarked: line connected at: (underside/upside)	-	N/A
	Tightening, torques: (Nm)	50 Nm	P
	Test sequence of operation: O – t – CO	Compliance	P
	- test voltage $U/U_e = 1,05$ (V) ..... L1: ..... L2: ..... L3:	L1: 484,6 V L2: 485,5 V L3: 484,4 V	P
	- r.m.s. test current AC/DC: (A)..... L1: ..... L2: ..... L3:	L1: 67,0 kA L2: 65,7 kA L3: 65,8 kA	P
	power factor/time constant :	0,20	P
	- Factor "n"	2,25	P
	- peak test current (Amax) :	149,3 kA	P
	Test sequence "O"		
	- max. let-through current: (kA <sub>peak</sub> ) ..... L1: ..... L2: ..... L3:	L1: 140,3 kA L2: 111,6 kA L3: 105,7 kA	P
	- Joule integral $I^2dt$ (A <sup>2</sup> s) ..... L1: ..... L2: ..... L3:	L1: 98,9 MA <sup>2</sup> s L2: 65,2 MA <sup>2</sup> s L3: 50,2 MA <sup>2</sup> s	P
	Pause, t: (min)	5	P
	Test sequence "CO"		
	- max. let-through current: (kA <sub>peak</sub> ) ..... L1: ..... L2: ..... L3:	L1: 98,7 kA L2: 130,0 kA L3: 125,9 kA	P
	- Joule integral $I^2dt$ (A <sup>2</sup> s) ..... L1: ..... L2: ..... L3:	L1: 58,9 MA <sup>2</sup> s L2: 93,2 MA <sup>2</sup> s L3: 93,3 MA <sup>2</sup> s	P
	Melting of the fusible element	Compliance	P
	Holes in the PE-sheet for test sequence "O"	-	N/A
	Cracks observed	Compliance	P
8.3.5.3	Verification of dielectric withstand		
	- equal to twice the rated operational voltage with a minimum of 1000 V for 5 seconds	1000 V	P
	- no breakdown or flashover	No	P

TRF No. IEC60947\_2E





IEC 60947-2			
Clause	Requirement + Test	Result - Remark	Verdict
	- the leaking current for circuit-breaker suitable for isolation: (<6mA / 1,1 Ue)	≤ 3,0 mA / 506 V	P
8.3.5.4	Verification of overload releases		
	The operation of overload releases shall be verified at 2,5 times the value of their current setting on each pole separately.		
	The operating time shall not exceed the max. value stated by the manufacturer for twice the current setting at the reference temperature, on a pole singly.		
	Time specified by the manufacturer:	92~182 s	P
	- Operation time: (s) ..... L1:	127 s	P
	..... L2:	128 s	
	..... L3:	127 s	
	..... N:		

8.3.5	TEST SEQUENCE III (Icu)		
	Rated ultimate short-circuit breaking		
	Except where the combined test sequence applies, this test sequence applies to circuit-breaker of utilization category A and to circuit-breaker of utilization B having a rated ultimate short-circuit breaking capacity higher than the rated short-time withstand current.		
	For circuit-breakers of utilization B having a rated short-time withstand current equal to their rated ultimate short-circuit breaking capacity, this test sequence need not be made, since, in this case, the ultimate short-circuit breaking capacity, is verified when carrying out test sequence IV.		
	For integrally fused circuit-breakers, test sequence V applies in place of this sequence.		
	Type designation or serial number	TS1600H 3P	
	Sample no:	S3-4Rev	
	Rated current: In (A)	1600 A	
	Rated operational voltage: Ue (V)	690 V	
	Rated ultimate short-circuit breaking capacity: (kA)	45 kA	
	Rated control supply voltage of closing mechanism: Uc (V)		
	Rated control supply voltage of shunt release: Uc (V)		

TRF No. IEC60947\_2F



IEC 60947-2			
Clause	Requirement + Test	Result - Remark	Verdict
	This test sequence need not be made when Icu = Ics		
8.3.5.1	The operation of overload releases shall be verified at twice the value of their current setting on each pole separately.		
	The operating time shall not exceed the max. value stated by the manufacturer for twice the current setting at the reference temperature, on a pole singly.		
	Time specified by the manufacturer:	152~317 s	P
	- Operation time: (s) ..... L1:	214 s	P
	..... L2:	203 s	
	..... L3:	211 s	
	..... N :		
8.3.5.2	Test of rated ultimate short-circuit breaking capacity		
	The test sequence of operations is O – t – CO		
	For circuit-breaker fitted with adjustable releases, test shall be made with the current and time settings at maximum.	Compliance	P
	closing mechanism energized with 85% at the rated Uc: (V)	-	N/A
	The circuit-breaker is mounted complete on its own support or an equivalent support.	Compliance	P
	Test made in free air:	Compliance	P
	Distances of the metallic screen's: (all sides)	Side : 73.5 mm, Front : 0 mm Top bottom : no screen	P
	The characteristics of the metallic screen:		
	- woven wire mesh	-	N/A
	- perforated metal	Compliance	P
	- expanded metal	-	N/A
	- ratio hole area/total area: 0,45-0,65	0,5	P
	- size of hole: <30mm <sup>2</sup>	< 30mm <sup>2</sup>	P
	- finish: bare or conductive plating	Compliance	P
	Test made in specified individual enclosure: Details of these tests, including the dimensions of the enclosure:	-	N/A
	Fuse "F": copper wire: diameter 0,8 mm, 50 mm long	Compliance	P
	Circuit is earthed at: (load-star- or supply-star point)	Load-star point	P
	Conductor cross-sectional area (mm <sup>2</sup> ) :	2CX50X10 mm <sup>2</sup>	P

TRF No. IEC60947\_2F

ВЯРНО С  
ОРИГИНАЛА

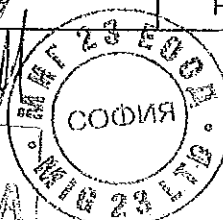

783

IEC 60947-2			
Clause	Requirement + Test	Result - Remark	Verdict
	If terminals unmarked: line connected at: (underside/upside)	-	N/A
	Tightening, torques: (Nm)	50 Nm	P
	Test sequence of operation: O – t – CO	Compliance	P
	- test voltage U/Ue = 1,05 (V) ..... L1: ..... L2: ..... L3:	L1: 734,8 V L2: 734,8 V L3: 733,0 V	P
	- r.m.s. test current AC/DC: (A)..... L1: ..... L2: ..... L3:	L1: 45,3 kA L2: 45,0 kA L3: 45,3 kA	P
	power factor/time constant :	0,24	P
	- Factor "n"	2,13	P
	- peak test current (Amax) :	96,6 kA	P
	Test sequence "O"		
	- max. let-through current: (kA <sub>peak</sub> ) ..... L1: ..... L2: ..... L3:	L1: 95,8 kA L2: 74,1 kA L3: 79,1 kA	P
	- Joule integral I <sup>2</sup> dt (A <sup>2</sup> s) ..... L1: ..... L2: ..... L3:	L1: 52,1 MA <sup>2</sup> s L2: 33,8 MA <sup>2</sup> s L3: 32,0 MA <sup>2</sup> s	P
	Pause, t (min)	10	P
	Test sequence "CO"		
	- max. let-through current: (kA <sub>peak</sub> ) ..... L1: ..... L2: ..... L3:	L1: 94,3 kA L2: 86,4 kA L3: 69,1 kA	P
	- Joule integral I <sup>2</sup> dt (A <sup>2</sup> s) ..... L1: ..... L2: ..... L3:	L1: 48,9 MA <sup>2</sup> s L2: 43,5 MA <sup>2</sup> s L3: 28,0 MA <sup>2</sup> s	P
	Melting of the fusible element	Compliance	P
	Holes in the PE-sheet for test sequence "O"	-	N/A
	Cracks observed	Compliance	P
8.3.5.3	Verification of dielectric withstand		
	- equal to twice the rated operational voltage with a minimum of 1000 V for 5 seconds	1 380 V	P
	- no breakdown or flashover	No	P

TRF No. IEC60947\_2F

ВЯРНО С  
ОРИГИНАЛА

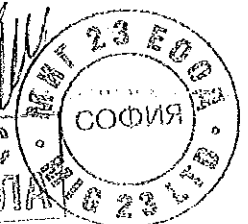

209

IEC 60947-2			
Clause	Requirement + Test	Result - Remark	Verdict
	- the leaking current for circuit-breaker suitable for isolation: (<6mA / 1,1 Ue)	≤ 0,78 mA / 759 V	P
8.3.5.4	Verification of overload releases		
	The operation of overload releases shall be verified at 2,5 times the value of their current setting on each pole separately.		
	The operating time shall not exceed the max. value stated by the manufacturer for twice the current setting at the reference temperature, on a pole singly.		
	Time specified by the manufacturer:	92~182 s	P
	- Operation time: (s) ..... L1: ..... L2: ..... L3: ..... N:	127 s 126 s 126 s	P

8.3.5	TEST SEQUENCE III (Icu)		
	Rated ultimate short-circuit breaking		
	Except where the combined test sequence applies, this test sequence applies to circuit-breaker of utilization category A and to circuit-breaker of utilization B having a rated ultimate short-circuit breaking capacity higher than the rated short-time withstand current.		
	For circuit-breakers of utilization B having a rated short-time withstand current equal to their rated ultimate short-circuit breaking capacity, this test sequence need not be made, since, in this case, the ultimate short-circuit breaking capacity, is verified when carrying out test sequence IV.		
	For integrally fused circuit-breakers, test sequence V applies in place of this sequence.		
	Type designation or serial number	TS1600H 4P	
	Sample no:	S3-1	
	Rated current: In (A)	1600 A	
	Rated operational voltage: Ue (V)	240 V	
	Rated ultimate short-circuit breaking capacity: (kA)	75 kA	
	Rated control supply voltage of closing mechanism: Uc (V)		
	Rated control supply voltage of shunt release: Uc (V)		



IEC 60947-2			
Clause	Requirement + Test	Result - Remark	Verdict
	This test sequence need not be made when Icu = Ics		
8.3.5.1	The operation of overload releases shall be verified at twice the value of their current setting on each pole separately.		
	The operating time shall not exceed the max. value stated by the manufacturer for twice the current setting at the reference temperature, on a pole singly.		
	Time specified by the manufacturer:	152~317 s	P
	- Operation time: (s) ..... L1:	226 s	P
	..... L2:	215 s	
	..... L3:	214 s	
	..... N :		
8.3.5.2	Test of rated ultimate short-circuit breaking capacity		
	The test sequence of operations is O – t – CO		
	For circuit-breaker fitted with adjustable releases, test shall be made with the current and time settings at maximum.	Compliance	P
	closing mechanism energized with 85% at the rated Uc: (V)	-	N/A
	The circuit-breaker is mounted complete on its own support or an equivalent support.	Compliance	P
	Test made in free air:	Compliance	P
	Distances of the metallic screen's: (all sides)	Side : 73.5 mm, Front : 0 mm Top bottom : no screen	P
	The characteristics of the metallic screen:		
	- woven wire mesh	-	N/A
	- perforated metal	Compliance	P
	- expanded metal	-	N/A
	- ratio hole area/total area: 0,45-0,65	0,5	P
	- size of hole: <30mm <sup>2</sup>	< 30mm <sup>2</sup>	P
	- finish: bare or conductive plating	Compliance	P
	Test made in specified individual enclosure: Details of these tests, including the dimensions of the enclosure:	-	N/A
	Fuse "F": copper wire: diameter 0,8 mm, 50 mm long	Compliance	P
	Circuit is earthed at: (load-star- or supply-star point)	Load-star point	P
	Conductor cross-sectional area (mm <sup>2</sup> ) :	2CX50X10 mm <sup>2</sup>	P

TRF No. IEC60947\_2F

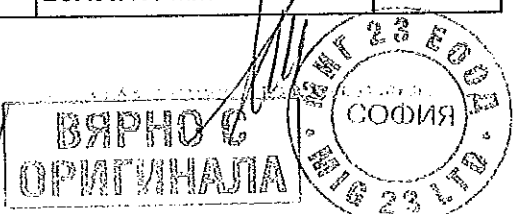

180

IEC 60947-2			
Clause	Requirement + Test	Result - Remark	Verdict
	If terminals unmarked: line connected at: (underside/upside)	-	N/A
	Tightening, torques: (Nm)	50 Nm	P
	Test sequence of operation: O – t – CO	Compliance	P
	- test voltage U/Us = 1,05 (V) ..... L1: ..... L2: ..... L3:	L1: 253,4 V L2: 253,3 V L3: 253,5 V	P
	- r.m.s. test current AC/DC: (A)..... L1: ..... L2: ..... L3:	L1: 75,9 kA L2: 76,3 kA L3: 74,8 kA	P
	power factor/time constant :	0,20	P
	- Factor "n"	2,28	P
	- peak test current (Amax) :	172,9 kA	P
	Test sequence "O"		
	- max. let-through current: (kA <sub>peak</sub> ) ..... L1: ..... L2: ..... L3:	L1: 142,2 kA L2: 126,1 kA L3: 65,5 kA	P
	- Joule integral I <sup>2</sup> dt (A <sup>2</sup> s) ..... L1: ..... L2: ..... L3:	L1: 102,1 MA <sup>2</sup> s L2: 80,0 MA <sup>2</sup> s L3: 19,5 MA <sup>2</sup> s	P
	Pause, t (min)	4	P
	Test sequence "CO"		
	- max. let-through current: (kA <sub>peak</sub> ) ..... L1: ..... L2: ..... L3:	L1: 111,1 kA L2: 77,6 kA L3: 80,5 kA	P
	- Joule integral I <sup>2</sup> dt (A <sup>2</sup> s) ..... L1: ..... L2: ..... L3:	L1: 64,0 MA <sup>2</sup> s L2: 41,1 MA <sup>2</sup> s L3: 33,6 MA <sup>2</sup> s	P
	Melting of the fusible element	Compliance	P
	Holes in the PE-sheet for test sequence "O"	-	N/A
	Cracks observed	Compliance	P
8.3.5.3	Verification of dielectric withstand		
	- equal to twice the rated operational voltage with a minimum of 1000 V for 5 seconds	1000 V	P
	- no breakdown or flashover	No	P

*Handwritten signature and scribbles*

IEC 60947-2			
Clause	Requirement + Test	Result - Remark	Verdict
	- the leaking current for circuit-breaker suitable for isolation: (<6mA / 1,1 Ue)	≤ 0,1 mA / 264 V	P
8.3.5.4	Verification of overload releases		
	The operation of overload releases shall be verified at 2,5 times the value of their current setting on each pole separately.		
	The operating time shall not exceed the max. value stated by the manufacturer for twice the current setting at the reference temperature, on a pole singly.		
	Time specified by the manufacturer:	92~182 s	P
	- Operation time: (s) ..... L1:	123 s	P
	..... L2:	128 s	
	..... L3:	121 s	
	..... N :		

8.3.5	TEST SEQUENCE III (Icu)		
	Rated ultimate short-circuit breaking		
	Except where the combined test sequence applies, this test sequence applies to circuit-breaker of utilization category A and to circuit-breaker of utilization B having a rated ultimate short-circuit breaking capacity higher than the rated short-time withstand current.		
	For circuit-breakers of utilization B having a rated short-time withstand current equal to their rated ultimate short-circuit breaking capacity, this test sequence need not be made, since, in this case, the ultimate short-circuit breaking capacity, is verified when carrying out test sequence IV.		
	For integrally fused circuit-breakers, test sequence V applies in place of this sequence.		
	Type designation or serial number	TS1600H 4P	
	Sample no:	S3-2	
	Rated current: In (A)	630 A	
	Rated operational voltage: Ue (V)	240 V	
	Rated ultimate short-circuit breaking capacity: (kA)	75 kA	
	Rated control supply voltage of closing mechanism: Uc (V)		
	Rated control supply voltage of shunt release: Uc (V)		

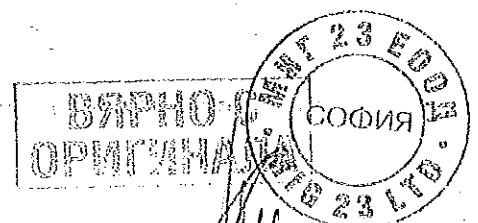

788

IEC 60947-2			
Clause	Requirement + Test	Result - Remark	Verdict
	This test sequence need not be made when Icu = Ics		
8.3.5.1	The operation of overload releases shall be verified at twice the value of their current setting on each pole separately.		
	The operating time shall not exceed the max. value stated by the manufacturer for twice the current setting at the reference temperature, on a pole singly.		
	Time specified by the manufacturer:	152~317 s	P
	- Operation time: (s) ..... L1:	222 s	P
	..... L2:	224 s	
	..... L3:	220 s	
	..... N :		
8.3.5.2	Test of rated ultimate short-circuit breaking capacity		
	The test sequence of operations is O – t – CO		
	For circuit-breaker fitted with adjustable releases, test shall be made with the current and time settings at maximum.	Compliance	P
	closing mechanism energized with 85% at the rated Uc: (V)	-	N/A
	The circuit-breaker is mounted complete on its own support or an equivalent support.	Compliance	P
	Test made in free air:	Compliance	P
	Distances of the metallic screen's: (all sides)	Side : 73.5 mm, Front : 0 mm Top bottom : no screen	P
	The characteristics of the metallic screen:		
	- woven wire mesh	-	N/A
	- perforated metal	Compliance	P
	- expanded metal	-	N/A
	- ratio hole area/total area: 0,45-0,65	0,5	P
	- size of hole: <30mm <sup>2</sup>	<30mm <sup>2</sup>	P
	- finish: bare or conductive plating	Compliance	P
	Test made in specified individual enclosure: Details of these tests, including the dimensions of the enclosure:	-	N/A
	Fuse "F": copper wire: diameter 0,8 mm, 50 mm long	Compliance	P
	Circuit is earthed at: (load-star- or supply-star point)	Load-star point	P
	Conductor cross-sectional area (mm <sup>2</sup> ) :	2CX40X5 mm <sup>2</sup>	P

TRF No. IEC60947\_2F

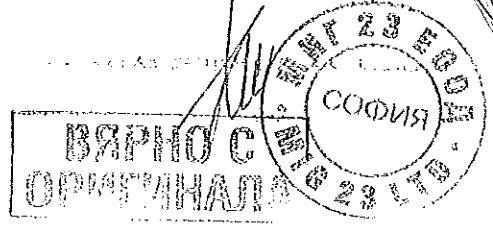



IEC 60947-2			
Clause	Requirement + Test	Result - Remark	Verdict
	If terminals unmarked: line connected at: (underside/upside)	-	N/A
	Tightening, torques: (Nm)	50 Nm	P
	Test sequence of operation: O – t – CO	Compliance	P
	- test voltage U/Ue = 1,05 (V) ..... L1: ..... L2: ..... L3:	L1: 253,4 V L2: 253,3 V L3: 253,5 V	P
	- r.m.s. test current AC/DC: (A)..... L1: ..... L2: ..... L3:	L1: 75,9 kA L2: 76,3 kA L3: 74,8 kA	P
	power factor/time constant :	0,20	P
	- Factor "n"	2,28	P
	- peak test current (Amax) :	172,9 kA	P
	Test sequence "O"		
	- max. let-through current: (kA <sub>peak</sub> ) ..... L1: ..... L2: ..... L3:	L1: 99,3 kA L2: 100,6 kA L3: 65,4 kA	P
	- Joule integral I <sup>2</sup> dt (A <sup>2</sup> s) ..... L1: ..... L2: ..... L3:	L1: 71,2 MA <sup>2</sup> s L2: 66,2 MA <sup>2</sup> s L3: 19,7 MA <sup>2</sup> s	P
	Pause, t: (min)	6	P
	Test sequence "CO"		
	- max. let-through current: (kA <sub>peak</sub> ) ..... L1: ..... L2: ..... L3:	L1: 121,8 kA L2: 148,7 kA L3: 58,4 kA	P
	- Joule integral I <sup>2</sup> dt (A <sup>2</sup> s) ..... L1: ..... L2: ..... L3:	L1: 69,5 MA <sup>2</sup> s L2: 106,2 MA <sup>2</sup> s L3: 18,4 MA <sup>2</sup> s	P
	Melting of the fusible element	Compliance	P
	Holes in the PE-sheet for test sequence "O"	-	N/A
	Cracks observed	Compliance	P
8.3.5.3	Verification of dielectric withstand		
	- equal to twice the rated operational voltage with a minimum of 1000 V for 5 seconds	1000 V	P
	- no breakdown or flashover	No	P

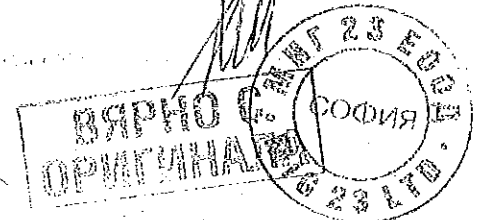

IEC 60947-2			
Clause	Requirement + Test	Result - Remark	Verdict
	- the leaking current for circuit-breaker suitable for isolation: (<6mA / 1,1 Ue)	≤ 0,45 mA / 264 V	P
8.3.5.4	Verification of overload releases		
	The operation of overload releases shall be verified at 2,5 times the value of their current setting on each pole separately.		
	The operating time shall not exceed the max. value stated by the manufacturer for twice the current setting at the reference temperature, on a pole singly.		
	Time specified by the manufacturer:	92~182 s	P
	- Operation time: (s) ..... L1:	130 s	P
	..... L2:	127 s	
	..... L3:	125 s	
	..... N :		

8.3.5	TEST SEQUENCE III (Icu)		
	Rated ultimate short-circuit breaking		
	Except where the combined test sequence applies, this test sequence applies to circuit-breaker of utilization category A and to circuit-breaker of utilization B having a rated ultimate short-circuit breaking capacity higher than the rated short-time withstand current.		
	For circuit-breakers of utilization B having a rated short-time withstand current equal to their rated ultimate short-circuit breaking capacity, this test sequence need not be made, since, in this case, the ultimate short-circuit breaking capacity, is verified when carrying out test sequence IV.		
	For integrally fused circuit-breakers, test sequence V applies in place of this sequence.		
	Type designation or serial number	TS1600H 4P	
	Sample no:	S3-3	
	Rated current: In (A)	1600 A	
	Rated operational voltage: Ue (V)	460 V	
	Rated ultimate short-circuit breaking capacity: (kA)	65 kA	
	Rated control supply voltage of closing mechanism: Uc (V)	-	
	Rated control supply voltage of shunt release: Uc (V)	-	

IEC 60947-2			
Clause	Requirement + Test	Result - Remark	Verdict
	This test sequence need not be made when $I_{cu} = I_{cs}$		
8.3.5.1	The operation of overload releases shall be verified at twice the value of their current setting on each pole separately.		
	The operating time shall not exceed the max. value stated by the manufacturer for twice the current setting at the reference temperature, on a pole singly.		
	Time specified by the manufacturer:	152~317 s	P
	- Operation time: (s) ..... L1: ..... L2: ..... L3: ..... N :	217 s 226 s 221 s	P
8.3.5.2	Test of rated ultimate short-circuit breaking capacity		
	The test sequence of operations is O – t – CO		
	For circuit-breaker fitted with adjustable releases, test shall be made with the current and time settings at maximum.	Compliance	P
	closing mechanism energized with 85% at the rated $U_c$ (V)	-	N/A
	The circuit-breaker is mounted complete on its own support or an equivalent support.	Compliance	P
	Test made in free air:	Compliance	P
	Distances of the metallic screen's: (all sides)	Side : 73.5 mm, Front : 0 mm Top bottom : no screen	P
	The characteristics of the metallic screen:		
	- woven wire mesh	-	N/A
	- perforated metal	Compliance	P
	- expanded metal	-	N/A
	- ratio hole area/total area: 0,45-0,65	0,5	P
	- size of hole: <30mm <sup>2</sup>	< 30mm <sup>2</sup>	P
	- finish: bare or conductive plating	Compliance	P
	Test made in specified individual enclosure: Details of these tests, including the dimensions of the enclosure:	-	N/A
	Fuse "F": copper wire: diameter 0,8 mm, 50 mm long	Compliance	P
	Circuit is earthed at: (load-star- or supply-star point)	Load-star point	P
	Conductor cross-sectional area (mm <sup>2</sup> ) :	2CX50X10 mm <sup>2</sup>	P

TRF No. IEC60947\_2F

ВЕРНО С  
ОРИГИНАЛА

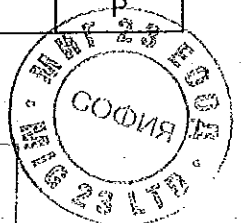

IEC 60947-2			
Clause	Requirement + Test	Result - Remark	Verdict
	If terminals unmarked: line connected at: (underside/upside)	-	N/A
	Tightening, torques: (Nm)	50 Nm	P
	Test sequence of operation: O – t – CO		
	- test voltage U/Us = 1,05 (V) ..... L1: ..... L2: ..... L3:	L1: 484,8 V L2: 485,4 V L3: 484,8 V	P
	- r.m.s. test current AC/DC: (A)..... L1: ..... L2: ..... L3:	L1: 67,0 kA L2: 65,7 kA L3: 65,8 kA	P
	power factor/time constant :	0,2	
	- Factor "n"	2.23	
	- peak test current (Amax) :	149,3 kA	
	Test sequence "O"		
	- max. let-through current: (kApeak) ..... L1: ..... L2: ..... L3:	L1: 99,3 kA L2: 100,7 kA L3: 100,4 kA	P
	- Joule integral I <sup>2</sup> dt (A <sup>2</sup> s) ..... L1: ..... L2: ..... L3:	L1: 68,1 MA <sup>2</sup> s L2: 59,8 MA <sup>2</sup> s L3: 48,1 MA <sup>2</sup> s	P
	Pause, t: (min)	2	P
	Test sequence "CO"		
	- max. let-through current: (kApeak) ..... L1: ..... L2: ..... L3:	L1: 127,7 kA L2: 134,2 kA L3: 80,0 kA	P
	- Joule integral I <sup>2</sup> dt (A <sup>2</sup> s) ..... L1: ..... L2: ..... L3:	L1: 77,3 MA <sup>2</sup> s L2: 91,8 MA <sup>2</sup> s L3: 40,0 MA <sup>2</sup> s	P
	Melting of the fusible element	Compliance	P
	Holes in the PE-sheet for test sequence "O"	-	N/A
	Cracks observed	Compliance	P
8.3.5.3	Verification of dielectric withstand		
	- equal to twice the rated operational voltage with a minimum of 1000 V for 5 seconds	1000 V	P
	- no breakdown or flashover	No	P

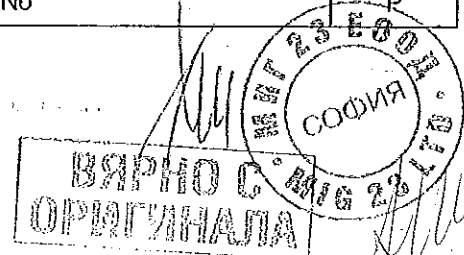

IEC 60947-2			
Clause	Requirement + Test	Result - Remark	Verdict
	- the leaking current for circuit-breaker suitable for isolation: (<6mA / 1,1 Ue)	≤ 0,78 mA / 506 V	P
8.3.5.4	Verification of overload releases		
	The operation of overload releases shall be verified at 2,5 times the value of their current setting on each pole separately.		
	The operating time shall not exceed the max. value stated by the manufacturer for twice the current setting at the reference temperature, on a pole singly.		
	Time specified by the manufacturer:	92~182 s	P
	- Operation time: (s) ..... L1: ..... L2: ..... L3: ..... N :	124 s 120 s 121 s	P

8.3.5	TEST SEQUENCE III (Icu)		
	Rated ultimate short-circuit breaking		
	Except where the combined test sequence applies, this test sequence applies to circuit-breaker of utilization category A and to circuit-breaker of utilization B having a rated ultimate short-circuit breaking capacity higher than the rated short-time withstand current.		
	For circuit-breakers of utilization B having a rated short-time withstand current equal to their rated ultimate short-circuit breaking capacity, this test sequence need not be made, since, in this case, the ultimate short-circuit breaking capacity, is verified when carrying out test sequence IV.		
	For integrally fused circuit-breakers, test sequence V applies in place of this sequence.		
	Type designation or serial number	TS1600H 4P	
	Sample no:	S3-4Rev	
	Rated current: In (A)	1600 A	
	Rated operational voltage: Ue (V)	690 V	
	Rated ultimate short-circuit breaking capacity: (kA)	45 kA	
	Rated control supply voltage of closing mechanism: Uc (V)		
	Rated control supply voltage of shunt release: Uc (V)		

IEC 60947-2			
Clause	Requirement + Test	Result - Remark	Verdict
	This test sequence need not be made when $I_{cu} = I_{cs}$		
8.3.5.1	The operation of overload releases shall be verified at twice the value of their current setting on each pole separately.		
	The operating time shall not exceed the max. value stated by the manufacturer for twice the current setting at the reference temperature, on a pole singly.		
	Time specified by the manufacturer:	152-317 s	P
	- Operation time: (s) ..... L1:	218 s	P
	..... L2:	218 s	
	..... L3:	224 s	
	..... N :		
8.3.5.2	Test of rated ultimate short-circuit breaking capacity		
	The test sequence of operations is O – t – CO		
	For circuit-breaker fitted with adjustable releases, test shall be made with the current and time settings at maximum.	Compliance	P
	closing mechanism energized with 85% at the rated $U_c$ : (V)	-	N/A
	The circuit-breaker is mounted complete on its own support or an equivalent support.	Compliance	P
	Test made in free air:	Compliance	P
	Distances of the metallic screen's: (all sides)	Side : 73.5 mm, Front : 0 mm Top bottom : no screen	P
	The characteristics of the metallic screen:		
	- woven wire mesh	-	N/A
	- perforated metal	Compliance	P
	- expanded metal	-	N/A
	- ratio hole area/total area: 0,45-0,65	0,5	P
	- size of hole: <30mm <sup>2</sup>	< 30mm <sup>2</sup>	P
	- finish: bare or conductive plating	Compliance	P
	Test made in specified individual enclosure: Details of these tests, including the dimensions of the enclosure:	-	N/A
	Fuse "F": copper wire: diameter 0,8 mm, 50 mm long	Compliance	P
	Circuit is earthed at: (load-star- or supply-star point)	Load-star point	P
	Conductor cross-sectional area (mm <sup>2</sup> ) :	2CX50X10 mm <sup>2</sup>	P

TRF No: IEC60947\_2F

ВЕРНО С  
КОПИИ НА  
МНТ 23 ЕОУ  
СОБИЯ  
МНТ 23 ЛТБ

795

IEC 60947-2			
Clause	Requirement + Test	Result - Remark	Verdict
	If terminals unmarked: line connected at: (underside/upside)	-	N/A
	Tightening, torques: (Nm)	50 Nm	P
	Test sequence of operation: O – t – CO	Compliance	P
	- test voltage U/Ue = 1,05 (V) ..... L1: ..... L2: ..... L3:	L1: 735,6 V L2: 732,7 V L3: 732,8 V	P
	- r.m.s. test current AC/DC: (A)..... L1: ..... L2: ..... L3:	L1: 45,3 kA L2: 45,0 kA L3: 45,3 kA	P
	power factor/time constant :	0,24	P
	- Factor "n"	2,14	P
	- peak test current (Amax) :	96,8 kA	P
	Test sequence "O"		
	- max. let-through current: (kA <sub>peak</sub> ) ..... L1: ..... L2: ..... L3:	L1: 95,5 kA L2: 73,9 kA L3: 79,3 kA	P
	- Joule integral I <sup>2</sup> dt (A <sup>2</sup> s) ..... L1: ..... L2: ..... L3:	L1: 52,1 MA <sup>2</sup> s L2: 38,1 MA <sup>2</sup> s L3: 36,8 MA <sup>2</sup> s	P
	Pause, t: (min)	3	P
	Test sequence "CO"		
	- max. let-through current: (kA <sub>peak</sub> ) ..... L1: ..... L2: ..... L3:	L1: 79,1 kA L2: 75,3 kA L3: 95,3 kA	P
	- Joule integral I <sup>2</sup> dt (A <sup>2</sup> s) ..... L1: ..... L2: ..... L3:	L1: 43,3 MA <sup>2</sup> s L2: 37,9 MA <sup>2</sup> s L3: 57,8 MA <sup>2</sup> s	P
	Melting of the fusible element	Compliance	P
	Holes in the PE-sheet for test sequence "O"	-	N/A
	Cracks observed	Compliance	P
8.3.5.3	Verification of dielectric withstand		
	- equal to twice the rated operational voltage with a minimum of 1000 V for 5 seconds	1380 V	P
	- no breakdown or flashover	No	P

TRF.No.-IEC60947\_2F



796

IEC 60947-2			
Clause	Requirement + Test	Result - Remark	Verdict
	- the leaking current for circuit-breaker suitable for isolation: (<6mA / 1,1 Ue)	≤ 1,0 mA / 759 V	P
8.3.5.4	Verification of overload releases		
	The operation of overload releases shall be verified at 2,5 times the value of their current setting on each pole separately.		
	The operating time shall not exceed the max. value stated by the manufacturer for twice the current setting at the reference temperature, on a pole singly.		
	Time specified by the manufacturer:	92~182 s	P
	- Operation time: (s) ..... L1:	127 s	P
	..... L2:	127 s	
	..... L3:	127 s	
	..... N:		

8.3.5	TEST SEQUENCE III (Icu)		
	Rated ultimate short-circuit breaking		
	Except where the combined test sequence applies, this test sequence applies to circuit-breaker of utilization category A and to circuit-breaker of utilization B having a rated ultimate short-circuit breaking capacity higher than the rated short-time withstand current.		
	For circuit-breakers of utilization B having a rated short-time withstand current equal to their rated ultimate short-circuit breaking capacity, this test sequence need not be made, since, in this case, the ultimate short-circuit breaking capacity, is verified when carrying out test sequence IV.		
	For integrally fused circuit-breakers, test sequence V applies in place of this sequence.		
	Type designation or serial number	TS1600H 4P	
	Sample no:	S3-5	
	Rated current: In (A)	1600 A	
	Rated operational voltage: Ue (V)	240 V/√ 3	
	Rated ultimate short-circuit breaking capacity: (kA)	75 kA	
	Rated control supply voltage of closing mechanism: Uc (V)		
	Rated control supply voltage of shunt release: Uc (V)		

TRF No. IEC60947\_2F



798



IEC 60947-2			
Clause	Requirement + Test	Result - Remark	Verdict
	This test sequence need not be made when Icu = Ics		
8.3.5.1	The operation of overload releases shall be verified at twice the value of their current setting on each pole separately.		
	The operating time shall not exceed the max. value stated by the manufacturer for twice the current setting at the reference temperature, on a pole singly.		
	Time specified by the manufacturer:	152~317 s	P
	- Operation time: (s) ..... L1: ..... L2: ..... L3: ..... N :	230 s - - 230 s	P
8.3.5.2	Test of rated ultimate short-circuit breaking capacity		
	The test sequence of operations is O – t – CO		
	For circuit-breaker fitted with adjustable releases, test shall be made with the current and time settings at maximum.	Compliance	P
	closing mechanism energized with 85% at the rated Uc: (V)	-	N/A
	The circuit-breaker is mounted complete on its own support or an equivalent support.	Compliance	P
	Test made in free air:	Compliance	P
	Distances of the metallic screen's: (all sides)	Side : 73.5 mm, Front : 0 mm Top bottom : no screen	P
	The characteristics of the metallic screen:		
	- woven wire mesh	-	N/A
	- perforated metal	Compliance	P
	- expanded metal	-	N/A
	- ratio hole area/total area: 0,45-0,65	0,5	P
	- size of hole: <30mm <sup>2</sup>	< 30mm <sup>2</sup>	P
	- finish: bare or conductive plating	Compliance	P
	Test made in specified individual enclosure: Details of these tests, including the dimensions of the enclosure:	-	N/A
	Fuse "F": copper wire: diameter 0,8 mm, 50 mm long	Compliance	P
	Circuit is earthed at: (load-star- or supply-star point)	Load-star point	P
	Conductor cross-sectional area (mm <sup>2</sup> ):	2CX50X10 mm <sup>2</sup>	P

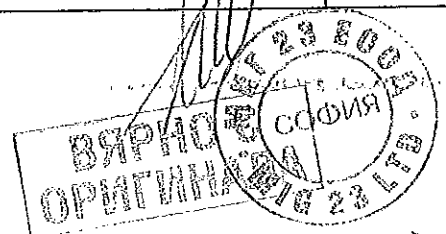

798

IEC 60947-2			
Clause	Requirement + Test	Result - Remark	Verdict
	If terminals unmarked: line connected at: (underside/upside)	-	N/A
	Tightening, torques: (Nm)	50 Nm	P
	Test sequence of operation: O – t – CO	Compliance	P
	- test voltage $U/U_e = 1,05$ (V) ..... L1: ..... L2: ..... L3:	L1: 145,8 V	P
	- r.m.s. test current AC/DC: (A)..... L1: ..... L2: ..... L3:	L1: 77,7 kA	P
	power factor/time constant :	0,20	P
	- Factor "n"	2,15	P
	- peak test current ( $A_{max}$ ) :	167,5 kA	P
	Test sequence "O"		
	- max. let-through current: ( $kA_{peak}$ ) ..... L1: ..... L2: ..... L3:	L1: 122,9 kA	P
	- Joule integral $I^2dt$ ( $A^2s$ ) ..... L1: ..... L2: ..... L3:	L1: 67,9 $MA^2s$	P
	Pause, t: (min)	4	
	Test sequence "CO"		
	- max. let-through current: ( $kA_{peak}$ ) ..... L1: ..... L2: ..... L3:	L1: 110,2 kA	P
	- Joule integral $I^2dt$ ( $A^2s$ ) ..... L1: ..... L2: ..... L3:	L1: 56,4 $MA^2s$	P
	Melting of the fusible element	Compliance	P
	Holes in the PE-sheet for test sequence "O"	-	N/A
	Cracks observed	Compliance	P
8.3.5.3	Verification of dielectric withstand		
	- equal to twice the rated operational voltage with a minimum of 1000 V for 5 seconds	1000 V	P
	- no breakdown or flashover	No	P
	- the leaking current for circuit-breaker suitable for isolation: ( $<6mA / 1,1 U_e$ )	$\leq 0,77 mA / 264 V$	P

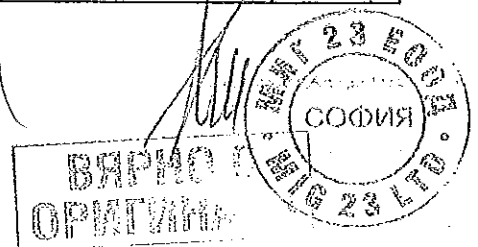

IEC 60947-2			
Clause	Requirement + Test	Result - Remark	Verdict
8.3.5.4	Verification of overload releases		
	The operation of overload releases shall be verified at 2,5 times the value of their current setting on each pole separately.		
	The operating time shall not exceed the max. value stated by the manufacturer for twice the current setting at the reference temperature, on a pole singly.		
	Time specified by the manufacturer:	92~182 s	P
	- Operation time: (s) ..... L1:	122 s	P
	..... L2:	-	
	..... L3:	-	
	..... N:	129 s	

8.3.6	TEST SEQUENCE IV		
	Rated short-time withstand current		
	Except where the combined test sequence applies, this test sequence applies to circuit-breakers of utilization category B and to those circuit-breaker of category A covered by note 3 of table 4, and comprises the following tests:		
	Where integrally fused circuit-breaker are of utilization category B, they shall meet the requirements of this sequence.		
	Type designation or serial number	TS1600H 3P	
	Sample no:	S4-1	
	Rated current: In (A)	1600 A	
	Rated operational voltage: Ue (V)	690 V	
	Rated short-time withstand current: (kA/s)	25 kA 1s	
	Rated frequency: (Hz)	60 Hz	
8.3.6.1	Verification of overload releases		
	The operation of overload releases shall be verified at twice the value of their current setting on each pole separately.		
	The operating time shall not exceed the max. value stated by the manufacturer for twice the current setting at the reference temperature, on a pole singly.		
	Time specified by the manufacturer:	152~317 s	P
	- Operation time: (s) ..... L1:	223 s	P
	..... L2:	229 s	
	..... L3:	211 s	
	..... N:		

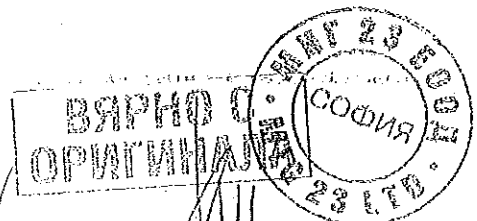

IEC 60947-2			
Clause	Requirement + Test	Result - Remark	Verdict
8.3.6.2	Test of rated short-time withstand current.		
	For this test, any over-current release, including the instantaneous override, if any, likely to operate during the test, shall be rendered inoperative.		
	- test frequency: (Hz)	60 Hz	P
	- duration of the test: (s)	1 s	P
	- test frequency: (Hz)	60 Hz	P
	- power factor / time constant (ms):	0,25	P
	- factor "n"	2,09	P
	- test voltage: (V) ..... L1: ..... L2: ..... L3:	L1: 724,9 V L2: 724,6 V L3: 724,9 V	P
	- r.m.s. test current: (kA) ..... L1: ..... L2: ..... L3:	L1: 25,5 kA L2: 25,6 kA L3: 25,4 kA	P
	- highest peak current: (kA)	53,5 kA	P
8.3.6.3	Verification of temperature-rise		
	- the values of temperature-rise do not exceed those specified in tab. 7.	See table S4-1 (3P)	P
	Temperature rise of main circuit terminals. ≤ 80 K (K) :	≤ 67,0 K	P
	conductor cross-sectional area (mm <sup>2</sup> ) :	500 mm <sup>2</sup> X 2	P
	test current I <sub>e</sub> (A) :	1600 A	P
8.3.6.4	Test of short-circuit breaking capacity at the max. short-time withstand current.		
	Rated short-time withstand current: (kA/s)		
	Test sequence: O – t – CO		
	max. available time setting of the short-time delay short-circuit release. (s)	0,4 s	P
	- test voltage U/U <sub>e</sub> = 1,05 (V) ..... L1: ..... L2: ..... L3:	L1: 724,9 V L2: 724,6 V L3: 724,9 V	P
	- r.m.s. test current AC/DC: (A) ..... L1: ..... L2: ..... L3:	L1: 25,5 kA L2: 25,6 kA L3: 25,4 kA	P
	- test frequency: (Hz)	60 Hz	P
	- power factor / time constant (ms):	0,25	P
	- factor "n"	2,09	P

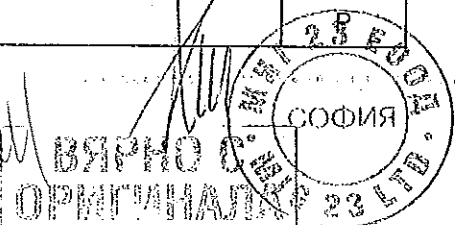

IEC 60947-2			
Clause	Requirement + Test	Result - Remark	Verdict
	Test sequence "O"		
	- max. let-through current: (kA <sub>peak</sub> ) ..... L1: ..... L2: ..... L3:	L1: 51,1 kA L2: 40,7 kA L3: 44,8 kA	P
	- Joule integral I <sup>2</sup> dt (A <sup>2</sup> s) ..... L1: ..... L2: ..... L3:	L1: 266,6 MA <sup>2</sup> s L2: 260,4 MA <sup>2</sup> s L3: 257,8 MA <sup>2</sup> s	P
	Pause, t: (min)	5	P
	- the circuit-breaker shall remain closed for the short-time corresponding to the max. available time setting of the short-time delay short-circuit release and -		P
	- the instantaneous override, if any, shall not operate.		P
	-pause: t (s)		
	Test sequence "CO"		
	- max. let-through current: (kA <sub>peak</sub> ) ..... L1: ..... L2: ..... L3:	L1: 49,8 kA L2: 38,4 kA L3: 46,3 kA	P
	- Joule integral I <sup>2</sup> dt (A <sup>2</sup> s) ..... L1: ..... L2: ..... L3:	L1: 7,8 MA <sup>2</sup> s L2: 8,3 MA <sup>2</sup> s L3: 1,2 MA <sup>2</sup> s	P
	Pause, t: (min)		
	- the circuit-breaker shall remain closed for the short-time corresponding to the max. available time setting of the short-time delay short-circuit release and -		P
	- the instantaneous override, if any, shall not operate.		P
	- if the circuit-breaker has a making current release, this requirement does not apply to the CO operation, if the prospective current exceeds the pre-determined value, since it will then operate.		P
8.3.6.5	Verification of dielectric withstand		
	- equal to twice the rated operational voltage with a minimum of 1000 V	1380 V	P
	- no breakdown or flashover	No	P
	- For circuit-breaker suitable for isolation, the leakage current shall be measured through each pole with the contacts in the open position, at a test voltage of 1,1 U <sub>e</sub> , and shall not exceed 2 mA.	≤ 0,03 mA / 759 V	P
8.3.6.6	Verification of overload releases		

IEC 60947-2			
Clause	Requirement + Test	Result - Remark	Verdict
	The operation of overload releases shall be verified at 2,5 times the value of their current setting on each pole separately.		
	The operating time shall not exceed the maximum value stated by the manufacturer for twice the value of the current setting, at the reference temperature, on a pole singly.		
	Time specified by the manufacturer:	92~182 s	P
	- Operation time: (s) ..... L1:	132 s	P
	..... L2:	130 s	
	..... L3:	129 s	
	..... N :		

8.3.6	TEST SEQUENCE IV		
	Rated short-time withstand current		
	Except where the combined test sequence applies, this test sequence applies to circuit-breakers of utilization category B and to those circuit-breaker of category A covered by note 3 of table 4, and comprises the following tests:		
	Where integrally fused circuit-breaker are of utilization category B, they shall meet the requirements of this sequence.		
	Type designation or serial number	TS1600H 4P	
	Sample no:	S4-1	
	Rated current: In (A)	1600 A	
	Rated operational voltage: Ue (V)	690 V/ 3	
	Rated short-time withstand current: (kA/s)	25 kA 1s	
	Rated frequency: (Hz)	60 Hz	
8.3.6.1	Verification of overload releases		
	The operation of overload releases shall be verified at twice the value of their current setting on each pole separately.		
	The operating time shall not exceed the max. value stated by the manufacturer for twice the current setting at the reference temperature, on a pole singly.		
	Time specified by the manufacturer:	152~317 s	P
	- Operation time: (s) ..... L1:	222 s	P
	..... L2:	221 s	
	..... L3:	230 s	
	..... N :	227 s	



IEC 60947-2			
Clause	Requirement + Test	Result - Remark	Verdict
8.3.6.2	Test of rated short-time withstand current.		
	For this test, any over-current release, including the instantaneous override, if any, likely to operate during the test, shall be rendered inoperative.		
	- test frequency: (Hz)	60 Hz	P
	- duration of the test: (s)	1 s	P
	- test frequency: (Hz)	60 Hz	P
	- power factor / time constant (ms):	0,25	P
	- factor "n"	2,09	P
	- test voltage: (V) ..... L1: ..... L2: ..... L3:	L1: 420,8 V	P
	- r.m.s. test current: (kA) ..... L1: ..... L2: ..... L3:	L1: 25,5 kA	P
	- highest peak current: (kA)	53,3 kA	P
8.3.6.3	Verification of temperature-rise		
	- the values of temperature-rise do not exceed those specified in tab. 7.	-	N/A
	Temperature rise of main circuit terminals. ≤ 80 K (K) :	-	N/A
	conductor cross-sectional area (mm <sup>2</sup> ) :	-	N/A
	test current I <sub>e</sub> (A) :	-	N/A
8.3.6.4	Test of short-circuit breaking capacity at the max. short-time withstand current.		
	Rated short-time withstand current: (kA/s)		
	Test sequence: O – t – CO		
	max. available time setting of the short-time delay short-circuit release. (s)	0,4 s	P
	- test voltage U/U <sub>e</sub> = 1,05 (V) ..... L1: ..... L2: ..... L3:	L1: 420,8 V	P
	- r.m.s. test current AC/DC: (A) ..... L1: ..... L2: ..... L3:	L1: 25,0 kA	P
	- test frequency (Hz)	60 Hz	P
	- power factor / time constant (ms):	0,25	P
	- factor "n"	2,12	P

TRF No. IEC60947\_2F



803

IEC 60947-2			
Clause	Requirement + Test	Result - Remark	Verdict
	Test sequence "O"		
	- max. let-through current: (kA <sub>peak</sub> ) ..... L1: ..... L2: ..... L3:	L1: 52,2 kA	P
	- Joule integral I <sup>2</sup> dt (A <sup>2</sup> s) ..... L1: ..... L2: ..... L3:	L1: 255,9 MA <sup>2</sup> s	P
	Pause, t: (min)	3	P
	- the circuit-breaker shall remain closed for the short-time corresponding to the max. available time setting of the short-time delay short-circuit release and -		P
	- the instantaneous override, if any, shall not operate.		P
	-pause: t (s)		P
	Test sequence "CO"		
	- max. let-through current: (kA <sub>peak</sub> ) ..... L1: ..... L2: ..... L3:	L1: 38,7 kA	P
	- Joule integral I <sup>2</sup> dt (A <sup>2</sup> s) ..... L1: ..... L2: ..... L3:	L1: 249,8 MA <sup>2</sup> s	P
	Pause, t: (min)		
	- the circuit-breaker shall remain closed for the short-time corresponding to the max. available time setting of the short-time delay short-circuit release and -		P
	- the instantaneous override, if any, shall not operate.		P
	- if the circuit-breaker has a making current release, this requirement does not apply to the CO operation, if the prospective current exceeds the pre-determined value, since it will then operate.		P
8.3.6.5	Verification of dielectric withstand		
	- equal to twice the rated operational voltage with a minimum of 1000 V	1380 V	P
	- no breakdown or flashover	No	P
	- For circuit-breaker suitable for isolation, the leakage current shall be measured through each pole with the contacts in the open position, at a test voltage of 1,1 U <sub>e</sub> , and shall not exceed 2 mA.	≤ 0,03 mA / 759 V	P
8.3.6.6	Verification of overload releases		



801



IEC 60947-2			
Clause	Requirement + Test	Result - Remark	Verdict
	The operation of overload releases shall be verified at 2,5 times the value of their current setting on each pole separately.		
	The operating time shall not exceed the maximum value stated by the manufacturer for twice the value of the current setting, at the reference temperature, on a pole singly.		
	Time specified by the manufacturer:	92~182 s	P
	- Operation time: (s) ..... L1:	123 s	P
	..... L2:	127 s	
	..... L3:	122 s	
	..... N:	124 s	

8.3.7	TEST SEQUENCE V	N/A
8.3.8	TEST SEQUENCE VI: Combined test sequence	N/A
Annex B	Circuit-breakers incorporating residual current protection	N/A
Annex C	Individual pole short-circuit test sequence	N/A

Annex F	Additional tests for circuit-breakers with electronic over-current protection	P
F4 and F5	Verification of electromagnetic compatibility (EMC)	P
	See report:	R410-1375 (A-Type)
F6	Suitability for multiple frequencies	N/A
	The tests shall be performed at each rated frequency or, when a range of rated frequencies is declared, at the lowest and the highest rated frequencies.	N/A
F.6.2	Tests shall be performed on any pair of phase-poles chosen at random at any convenient voltage. Under-voltage releases, if any, shall either be energized or disabled. All other auxiliaries shall be disconnected during the test.	N/A
	The short-time and instantaneous trip current settings shall each, if relevant, be adjusted to 2,5 times the current setting. If this setting is not available, the next closest higher setting shall be used.	N/A
	A current of 0,95 times the conventional non-tripping current (see Table 6) is applied for a time equal to 10 times the tripping time which corresponds to 2,0 times the current setting.	N/A
	Immediately following the test of a), a current of 1,05 times the conventional tripping current (see Table 6) is applied.	N/A

TRF No. IEC60947\_2F



805

IEC 60947-2			
Clause	Requirement + Test	Result - Remark	Verdict
	A further test starting from the cold state is made at 2,0 times the current setting.	-	N/A
	For each test frequency, the overload tripping characteristics shall comply with the following requirements: - for test a) no tripping shall occur; - for test b) tripping shall occur within the conventional time (see Table 6); - for test c) tripping shall occur within 1,1 times the maximum and 0,9 times the minimum values of the manufacturer's stated time-current characteristic.	-	N/A
F.7.	Dry heat test		P
F.7.1	The test shall be performed on the circuit-breaker in accordance with 7.2.2 at the maximum rated current for a given frame size, on all phase poles, at an ambient temperature of 40 °C	In= _____ A	N/A
	The duration of the test, once temperature equilibrium is reached, shall be 168 h		N/A
	Tightening torques applied to the terminals shall be in accordance with the manufacturers' instructions. In absence of such instructions, table 4 of IEC 60947-1 shall apply	Torque= _____ Nm	N/A
	As an alternative, the test may be performed as follows:	compliance	P
	- measure and record the highest temperature rise of the air surrounding the electronic components, during the temperature rise verification of test sequence 1	Ambient temperature during temperature rise test: 36.1 °C	P
	- install the electronic controls in the chamber	compliance	P
	- supply the electronic controls which there input energizing value	compliance	P
	- adjust the temperature of the test chamber to a value of 40 K above the temperature rise recorded for the surrounding the electronic components and maintain this temperature for 168 h	Chamber temperature: 76.1 °C	P
	Test carried out.....:	<input type="checkbox"/> normal <input checked="" type="checkbox"/> alternative	P
F.7.2	Test results		P
	The circuit-breaker and the electronic controls shall meet the following requirements:	compliance	P
	- no tripping of the circuit-breaker shall occur	compliance	P

TRF No. IEC60947\_2F

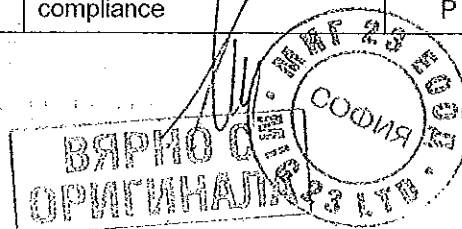

806

IEC 60947-2			
Clause	Requirement + Test	Result - Remark	Verdict
	- no operating of the electronic controls which would cause the circuit-breaker to trip shall occur	compliance	P
F.7.3	Verification of the overload releases		P
	Following the test F.7.1, the operation of the overload releases of the circuit-breaker shall be verified in accordance with 7.2.1.2.4, item b).	I test: 1680 A(1, 0 In x 1,05) I test: 2080 A(1, 0 In x 1,30) Ambient temperature: 20 °C	P
7.2.1.2.4	Opening by over-current releases	compliance	P
b)	Opening under overload conditions		N/A
1)	Instantaneous or definite time-delay operation	-	N/A
	The release shall cause tripping of the circuit-breaker with an accuracy of + 10% of the tripping current value of the current setting for all values of current setting of the overload release	-	N/A
2)	Inverse timer-delay operation		P
	At the reference temperature and at 1,05 times the current setting with the conventional non-tripping current, the opening release being energized on all poles, tripping shall not occur in less than the conventional time from the cold state, i.e. with the circuit-breaker at the reference temperature	No tripping	P
	Moreover, when at the end of the conventional time the value of current is immediately raised to 1,30 times the current setting, i.e. with the conventional tripping current, tripping shall then occur in less than the conventional time later	792 s	P
	If a release is declared by the manufacturer as substantially independent of ambient temperature, the current values of table 6 shall apply within the temperature band declared by the manufacturer, within a tolerance of 0,3%/K	-	N/A
	The width of the temperature band shall be at least 10 K on either side of the reference temperature	compliance	P
F.8.	Damp heat test		P
F.8.1	Test procedure	compliance	P
	The test shall be performed according to IEC 60068-2-30 ( 12 +12 hours cycle)	compliance	P
	Test Db temperature cycle between 25°C and upper temperature	compliance	P
	The upper temperature shall be 55°C ± 2 °C. (variant 1) and number of cycles shall be six.	compliance	P

TRF No. IEC60947\_2F

ВЯРНО С  
ОРИГИНАЛА

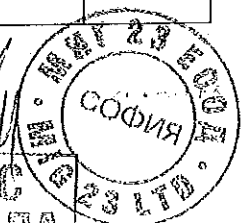

80

IEC 60947-2			
Clause	Requirement + Test	Result - Remark	Verdict
	The relative humidity is maintained at a high level at the upper temperature	compliance	P
	The test may be performed with only the electronic controls in the test chamber	compliance	P
	Test result.....:	compliance	P
F.8.2	Verification of the overload releases		P
	Following the test F.8.1, the operation of the overload releases of the circuit-breaker shall be verified in accordance with 7.2.1.2.4, item b).	I test: 1680 A(1, 0 In x 1,05) I test: 2080 A(1, 0 In x 1,30) Ambient temperature: 20 °C	P
7.2.1.2.4	Opening by over-current releases	compliance	P
b)	Opening under overload conditions		N/A
1)	Instantaneous or definite time-delay operation	-	N/A
	The release shall cause tripping of the circuit-breaker with an accuracy of + 10% of the tripping current value of the current setting for all values of current setting of the overload release	-	N/A
2)	Inverse timer-delay operation		P
	At the reference temperature and at 1,05 times the current setting with the conventional non-tripping current, the opening release being energized on all poles, tripping shall not occur in less than the conventional time from the cold state, i.e. with the circuit-breaker at the reference temperature	No tripping	P
	Moreover, when at the end of the conventional time the value of current is immediately raised to 1,30 times the current setting, i.e. with the conventional tripping current, tripping shall then occur in less than the conventional time later	786 s	P
	If a release is declared by the manufacturer as substantially independent of ambient temperature, the current values of table 6 shall apply within the temperature band declared by the manufacturer, within a tolerance of 0,3%/K	-	N/A
	The width of the temperature band shall be at least 10 K on either side of the reference temperature	compliance	P
F.9.	Temperature variation cycles at a specified rate of change		P
F.9.1	Test conditions		P
	Each design of electronic controls shall be submitted to temperature variation cycles in according with figure F.15	Compliance	P

IEC 60947-2			
Clause	Requirement + Test	Result - Remark	Verdict
	The rise and fall of temperature during the rate of variation shall be 1 K/min $\pm$ 0,2 K/min.	Compliance	P
	Their temperature, once reached, shall be maintained for at least 2 h.	Compliance	P
	The number of cycles shall be 28.	compliance	P
F.9.2	Test procedure		P
	The test shall be carried out according IEC 60068-2-14.	compliance	P
	For the these test, the electronic controls may be mounted inside the circuit-breaker or separately.	compliance	P
	The electronic controls shall be energized to simulate service conditions.	Compliance	P
	Where the electronics controls are mounted inside the circuit-breaker, the main circuit shall not be energized.	compliance	P
F.9.3	Test results		P
	The electronic controls shall meet the following requirement.	compliance	P
	No operation of the electronic controls which would cause the circuit-breaker to trip during the 28 cycles shall occur.	Compliance	P
F.9.4	Verification of overload releases	compliance	P
	Following the test F.9.1, the operation of the overload releases of the circuit-breaker shall be verified in accordance with 7.2.1.2.4, item b).	I test: 1680 A(1, 0 In x 1,05) I test: 2080 A(1, 0 In x 1,30) Ambient temperature: 20 °C	P
7.2.1.2.4	Opening by over-current releases	Compliance	P
b)	Opening under overload conditions	Compliance	P
1)	Instantaneous or definite time-delay operation.	-	N/A
	The release shall cause tripping of the circuit-breaker with an accuracy of + 10% of the tripping current value of the current setting for all values of current setting of the overload release	-	N/A
2)	Inverse timer-delay operation	Compliance	P
	At the reference temperature and at 1,05 times the current setting with the conventional non-tripping current, the opening release being energized on all poles, tripping shall not occur in less than the conventional time from the cold state, i.e. with the circuit-breaker at the reference temperature	No tripping	P

TRF No: IEC60947\_2F

ВЯРНО С  
ОРИГИНАЛА

СОФИЯ

23

809

IEC 60947-2			
Clause	Requirement + Test	Result - Remark	Verdict
	Moreover, when at the end of the conventional time the value of current is immediately raised to 1,30 times the current setting, i.e. with the conventional tripping current, tripping shall then occur in less than the conventional time later	754 s 	P
	If a release is declared by the manufacturer as substantially independent of ambient temperature, the current values of table 6 shall apply within the temperature band declared by the manufacturer, within a tolerance of 0,3%/K	-	N/A
	The width of the temperature band shall be at least 10 K on either side of the reference temperature	compliance	P

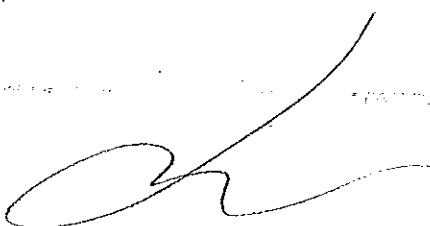
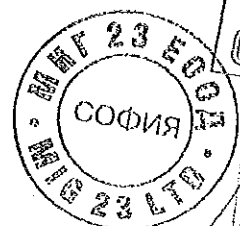
ВЯРНО С  
ОРИГИНАЛА

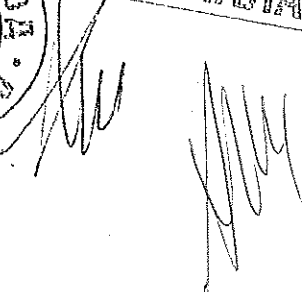

IEC 60947-2			
Clause	Requirement + Test	Result - Remark	Verdict
Annex F	Additional tests for circuit-breakers with electronic over-current protection		P
F4 and F5	Verification of electromagnetic compatibility (EMC)		P
	See report:	R410-1376 (S-Type)	P
F6	Suitability for multiple frequencies		N/A
	The tests shall be performed at each rated frequency or, when a range of rated frequencies is declared, at the lowest and the highest rated frequencies.		N/A
F.6.2	Tests shall be performed on any pair of phase-poles chosen at random at any convenient voltage. Under-voltage releases, if any, shall either be energized or disabled. All other auxiliaries shall be disconnected during the test.		N/A
	The short-time and instantaneous trip current settings shall each, if relevant, be adjusted to 2,5 times the current setting. If this setting is not available, the next closest higher setting shall be used.	-	N/A
	A current of 0,95 times the conventional non-tripping current (see Table 6) is applied for a time equal to 10 times the tripping time which corresponds to 2,0 times the current setting.	-	N/A
	Immediately following the test of a), a current of 1,05 times the conventional tripping current (see Table 6) is applied.	-	N/A
	A further test starting from the cold state is made at 2,0 times the current setting.	-	N/A
	For each test frequency, the overload tripping characteristics shall comply with the following requirements: - for test a) no tripping shall occur; - for test b) tripping shall occur within the conventional time (see Table 6); - for test c) tripping shall occur within 1,1 times the maximum and 0,9 times the minimum values of the manufacturer's stated time-current characteristic.	-	N/A
F.7.	Dry heat test		P
F.7.1	The test shall be performed on the circuit-breaker in accordance with 7.2.2 at the maximum rated current for a given frame size, on all phase poles, at an ambient temperature of 40 °C	In= _____ A	N/A
	The duration of the test, once temperature equilibrium is reached, shall be 168 h		N/A
	Tightening torques applied to the terminals shall be in accordance with the manufacturers' instructions. In absence of such instructions, table 4 of IEC 60947-1 shall apply	Torque= _____ Nm	N/A
	As an alternative, the test may be performed as	compliance	P



ВЯРНО С  
ОРИГИНАЛА

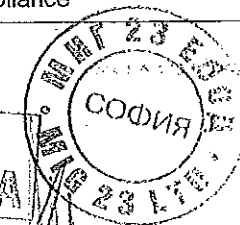

811

IEC 60947-2			
Clause	Requirement + Test	Result - Remark	Verdict
	follows:		
	- measure and record the highest temperature rise of the air surrounding the electronic components, during the temperature rise verification of test sequence 1	Ambient temperature during temperature rise test: 36.1 °C	P
	- install the electronic controls in the chamber	compliance	P
	- supply the electronic controls which there input energizing value	compliance	P
	- adjust the temperature of the test chamber to a value of 40 K above the temperature rise recorded for the surrounding the electronic components and maintain this temperature for 168 h	Chamber temperature: 76.1 °C	P
	Test carried out.....:	<input type="checkbox"/> normal <input checked="" type="checkbox"/> alternative	P
F.7.2	Test results		P
	The circuit-breaker and the electronic controls shall meet the following requirements:	compliance	P
	- no tripping of the circuit-breaker shall occur	compliance	P
	- no operating of the electronic controls which would cause the circuit-breaker to trip shall occur	compliance	P
F.7.3	Verification of the overload releases		P
	Following the test F.7.1, the operation of the overload releases of the circuit-breaker shall be verified in accordance with 7.2.1.2.4, item b).	I test: 1680 A(1, 0 In x 1,05) I test: 2080 A(1, 0 In x 1,30) Ambient temperature: 20 °C	P
7.2.1.2.4	Opening by over-current releases	compliance	P
b)	Opening under overload conditions		N/A
1)	Instantaneous or definite time-delay operation	-	N/A
	The release shall cause tripping of the circuit-breaker with an accuracy of + 10% of the tripping current value of the current setting for all values of current setting of the overload release	-	N/A
2)	Inverse timer-delay operation		P
	At the reference temperature and at 1,05 times the current setting with the conventional non-tripping current, the opening release being energized on all poles, tripping shall not occur in less than the conventional time from the cold state, i.e. with the circuit-breaker at the reference temperature	No tripping	P

TRF No. IEC60947\_2F

ВЯРНО С  
ОРИГИНАЛА

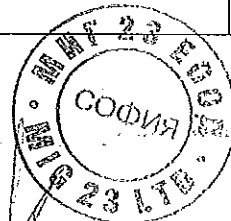

812



IEC 60947-2			
Clause	Requirement + Test	Result - Remark	Verdict
	Moreover, when at the end of the conventional time the value of current is immediately raised to 1,30 times the current setting, i.e. with the conventional tripping current, tripping shall then occur in less than the conventional time later	768 s	P
	If a release is declared by the manufacturer as substantially independent of ambient temperature, the current values of table 6 shall apply within the temperature band declared by the manufacturer, within a tolerance of 0,3%/K	-	N/A
	The width of the temperature band shall be at least 10 K on either side of the reference temperature	compliance	P
F.8.	Damp heat test		P
F.8.1	Test procedure	compliance	P
	The test shall be performed according to IEC 60068-2-30 ( 12 +12 hours cycle)	compliance	P
	Test Db temperature cycle between 25°C and upper temperature	compliance	P
	The upper temperature shall be 55°C ± 2 °C (variant 1) and number of cycles shall be six.	compliance	P
	The relative humidity is maintained at a high level at the upper temperature	compliance	P
	The test may be performed with only the electronic controls in the test chamber	compliance	P
	Test result.....	compliance	P
F.8.2	Verification of the overload releases		P
	Following the test F.8.1, the operation of the overload releases of the circuit-breaker shall be verified in accordance with 7.2.1.2.4, item b).	I test: 1680 A(1, 0 In x 1,05) I test: 2080 A(1, 0 In x 1,30) Ambient temperature: 20,°C	P
7.2.1.2.4	Opening by over-current releases	compliance	P
b)	Opening under overload conditions		N/A
1)	Instantaneous or definite time-delay operation	-	N/A
	The release shall cause tripping of the circuit-breaker with an accuracy of + 10% of the tripping current value of the current setting for all values of current setting of the overload release	-	N/A
2)	Inverse timer-delay operation		P

TRF No: IEC60947\_2F

ВЯРНО С  
ОРИГИНАЛА

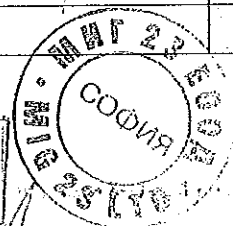

813

IEC 60947-2			
Clause	Requirement + Test	Result - Remark	Verdict
	At the reference temperature and at 1,05 times the current setting with the conventional non-tripping current, the opening release being energized on all poles, tripping shall not occur in less than the conventional time from the cold state, i.e. with the circuit-breaker at the reference temperature	No tripping	P
	Moreover, when at the end of the conventional time the value of current is immediately raised to 1,30 times the current setting, i.e. with the conventional tripping current, tripping shall then occur in less than the conventional time later	779 s	P
	If a release is declared by the manufacturer as substantially independent of ambient temperature, the current values of table 6 shall apply within the temperature band declared by the manufacturer, within a tolerance of 0,3%/K	-	N/A
	The width of the temperature band shall be at least 10 K on either side of the reference temperature	compliance	P
F.9.	Temperature variation cycles at a specified rate of change		P
F.9.1	Test conditions		P
	Each design of electronic controls shall be submitted to temperature variation cycles in according with figure F.15	Compliance	P
	The rise and fall of temperature during the rate of variation shall be 1 K/min ± 0,2 K/min.	Compliance	P
	Their temperature, once reached, shall be maintained for at least 2 h.	Compliance	P
	The number of cycles shall be 28.	compliance	P
F.9.2	Test procedure		P
	The test shall be carried out according IEC 60068-2-14.	compliance	P
	For the these test, the electronic controls may be mounted inside the circuit-breaker or separately.	compliance	P
	The electronic controls shall be energized to simulate service conditions.	Compliance	P
	Where the electronics controls are mounted inside the circuit-breaker, the main circuit shall not be energized.	compliance	P
F.9.3	Test results		P
	The electronic controls shall meet the following requirement.	compliance	P

TRF No. IEC60947-2F

ВЯРНО С  
ОРИГИНАЛА

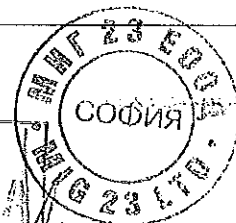

819

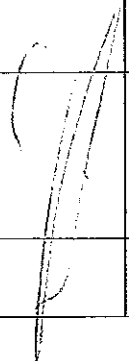
IEC 60947-2			
Clause	Requirement + Test	Result - Remark	Verdict
	No operation of the electronic controls which would cause the circuit-breaker to trip during the 28 cycles shall occur.	Compliance 	P
F.9.4	Verification of overload releases	compliance	P
	Following the test F.9.1, the operation of the overload releases of the circuit-breaker shall be verified in accordance with 7.2.1.2.4, item b).	I test: 1680 A(1, 0 In x 1,05) I test: 2080 A(1, 0 In x 1,30) Ambient temperature: 20 °C	P
7.2.1.2.4	Opening by over-current releases	Compliance	P
b)	Opening under overload conditions	Compliance	P
1)	Instantaneous or definite time-delay operation	-	N/A
	The release shall cause tripping of the circuit-breaker with an accuracy of + 10% of the tripping current value of the current setting for all values of current setting of the overload release	-	N/A
2)	Inverse timer-delay operation	Compliance	P
	At the reference temperature and at 1,05 times the current setting with the conventional non-tripping current, the opening release being energized on all poles, tripping shall not occur in less than the conventional time from the cold state, i.e. with the circuit-breaker at the reference temperature	No tripping	P
	Moreover, when at the end of the conventional time the value of current is immediately raised to 1,30 times the current setting, i.e. with the conventional tripping current, tripping shall then occur in less than the conventional time later	782 s	P
	If a release is declared by the manufacturer as substantially independent of ambient temperature, the current values of table 6 shall apply within the temperature band declared by the manufacturer, within a tolerance of 0,3%/K	- 	N/A
	The width of the temperature band shall be at least 10 K on either side of the reference temperature	compliance	P

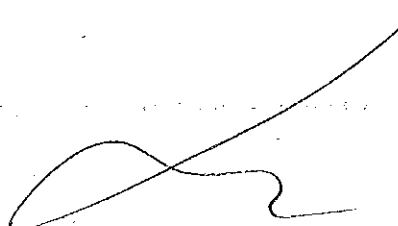

TRF No. IEC60947\_2F

ВЯРНО С  
ОРИГИНАЛА

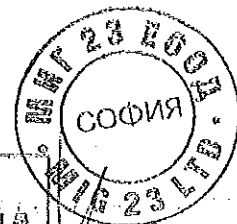
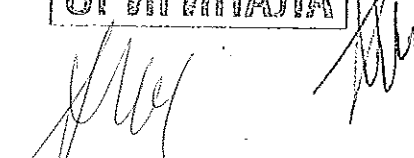
805

IEC 60947-2			
Clause	Requirement + Test	Result - Remark	Verdict
Annex H	Individual pole short-circuit test sequence		
	Circuit-breaker for use in IT systems		
H.2	Test of individual pole short-circuit breaking capacity		
	A short-circuit test is made on the individual poles of a multipole circuit-breaker at a value of prospective current ( $I_{pr}$ ) equal to 1,2 times the maximum setting of the short-time delay release tripping current or, in the absence of such a release, 1,2 time the max. setting of the tripping current of the instantaneous release, or, where relevant 1,2 times the maximum setting of the definite time delay release tripping current, but not less than 500 A nor exceeding 50kA.		
	Type designation or serial number	TS1600H 3P	
	Sample no:	H-1	
	Rated current: $I_n$ (A)	1600 A	
	Rated operational voltage: $U_e$ (V)	690 V	
	Rated ultimate short-circuit breaking capacity: (kA)	45 kA	
	Rated control supply voltage of closing mechanism: $U_c$ (V)		
	Rated control supply voltage of shunt release: $U_c$ (V)		
	The test sequence of operations is O – t – CO		
	For circuit-breaker fitted with adjustable releases, test shall be made with the current and time settings at maximum.	Compliance	P
	closing mechanism energized with 85% at the rated $U_c$ (V)	-	N/A
	The circuit-breaker is mounted complete on its own support or an equivalent support.	Compliance	P
	Test made in free air:	Compliance	P
	Distances of the metallic screen's: (all sides)	Side : 73.5 mm, Front : 0 mm Top bottom : no screen	P
	The characteristics of the metallic screen:		
	- woven wire mesh	-	N/A
	- perforated metal	Compliance	P
	- expanded metal	-	N/A
	- ratio hole area/total area: 0,45-0,65	0,5	P
	- size of hole: <30mm <sup>2</sup>	<30mm <sup>2</sup>	P

IEC 60947-2			
Clause	Requirement + Test	Result - Remark	Verdict
	- finish: bare or conductive plating	Compliance	P
	Test made in specified individual enclosure: Details of these tests, including the dimensions of the enclosure:	-	N/A
	Fuse "F": copper wire: diameter 0,8 mm, 50 mm long	Compliance	P
	Circuit is earthed at: (load-star- or supply-star point)	Load-star point	P
	Conductor cross-sectional area (mm <sup>2</sup> ):	2CX50X10 mm <sup>2</sup>	P
	If terminals unmarked: line connected at: (underside/upside)	-	N/A
	Tightening torques: (Nm)	50 Nm	P
	Test sequence of operation: O – t – CO	Compliance	P
	Test circuit according figure: 9	Compliance	P
	- test voltage U/U <sub>e</sub> = 1,05 (V) ..... L1: ..... L2: ..... L3:	L1: 735,3 V	P
	Short-circuit test current (I <sub>sc</sub> ): equal to 1,2 times the max. setting of the short-time delay release tripping current,	19,2 kA	P
	or, in the absence of such a release, 1,2 time the max. setting of the tripping current of the instantaneous release,	Compliance	P
	or, where relevant 1,2 times the max. setting of the definite time delay release tripping current, but not exceeding 50kA.	-	N.A.
	- r.m.s. test current AC/DC: (A)	19,2 kA	P
	power factor/time constant:	0,30	P
	- Factor "n"	2,01	P
	- peak test current (A <sub>max</sub> ) :	38,6 kA	P
	Test sequence "O" L1		
	- max. let-through current: (kA <sub>peak</sub> ) ..... L1:	37,7 kA	P
	- Joule integral I <sup>2</sup> dt (A <sup>2</sup> s) ..... L1:	154,7 MA <sup>2</sup> s	P
	Pause t <sub>1</sub> (min)	3	P
	Test sequence "CO" L1		
	- max. let-through current: (kA <sub>peak</sub> ) ..... L1:	32,7 kA	P
	- Joule integral I <sup>2</sup> dt (A <sup>2</sup> s) ..... L1:	150,9 MA <sup>2</sup> s	P

TRF No. IEC60947\_2F

ВЯРНО С  
ОРИГИНАЛА

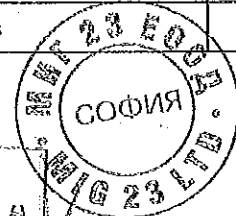

IEC 60947-2			
Clause	Requirement + Test	Result - Remark	Verdict
	Test sequence "O" L2		
	- max. let-through current: (kA <sub>peak</sub> ) ..... L2:	37,4 kA	P
	- Joule integral I <sup>2</sup> dt (A <sup>2</sup> s) ..... L2:	154,3 MA <sup>2</sup> s	P
	Pause, t: (min)	4	P
	Test sequence "CO" L2		
	- max. let-through current: (kA <sub>peak</sub> ) ..... L2:	31,1 kA	P
	- Joule integral I <sup>2</sup> dt (A <sup>2</sup> s) ..... L2:	150,6 MA <sup>2</sup> s	P
	Test sequence "O" L3		
	- max. let-through current: (kA <sub>peak</sub> ) ..... L3:	37,6 kA	P
	- Joule integral I <sup>2</sup> dt (A <sup>2</sup> s) ..... L3:	154,2 MA <sup>2</sup> s	P
	Pause, t: (min)	5	P
	Test sequence "CO" L3		
	- max. let-through current: (kA <sub>peak</sub> ) ..... L3:	33,9 kA	P
	- Joule integral I <sup>2</sup> dt (A <sup>2</sup> s) ..... L3:	150,8 MA <sup>2</sup> s	P
	For 4-pole circuit-breakers with a protected neutral pole, the test voltage for that pole shall be phase-to-phase voltage divided by $\sqrt{3}$ . This test is applicable only where the construction of the protected neutral pole differs from that of the phase poles.	-	N.A.
	Test sequence "O" N		
	- max. let-through current: (kA <sub>peak</sub> ) ..... N:	-	N.A.
	- Joule integral I <sup>2</sup> dt (A <sup>2</sup> s) ..... N:	-	N.A.
	Pause, t: (min)	-	N.A.
	Test sequence "CO" N		
	- max. let-through current: (kA <sub>peak</sub> ) ..... N:	-	N.A.
	- Joule integral I <sup>2</sup> dt (A <sup>2</sup> s) ..... N:	-	N.A.
	Melting of the fusible element	Compliance	P
	Holes in the PE-sheet for test sequence "O"	-	N/A
	Cracks observed	Compliance	P
H:3	Verification of dielectric withstand		
	- equal to twice the rated operational voltage with a minimum of 1000 V	1380 V	P
	- no breakdown or flashover	No	P

IEC 60947-2			
Clause	Requirement + Test	Result - Remark	Verdict
H.4	Verification of overload releases		
	The operation of overload releases shall be verified at 2.5 times the value of their current setting on each pole separately.		
	The operating time shall not exceed the max. value stated by the manufacturer for twice the current setting at the reference temperature, on a pole singly.		
	Time specified by the manufacturer:	92~182 s	P
	- Operation time: (s) ..... L1:	133 s	P
	..... L2:	129 s	
	..... L3:	129 s	
	..... N:		
H.5	Marking		
	Circuit-breaker for which all values of rated voltage have not been tested according to this annex or are not covered by such testing, shall be identified by the symbol  which shall be marked on the circuit-breaker immediately following these values of rated voltage	Compliance	P

Annex J	Electromagnetic compatibility (EMC) – Requirements and test methods for circuit-breakers: see report no. EMC-PW-6538	P
Annex N	Electromagnetic compatibility (EMC) – Additional requirements and test methods for devices not covered by Annexes B, F and M	N/A
Annex O	Instantaneous trip circuit-breakers (ICB)	N/A

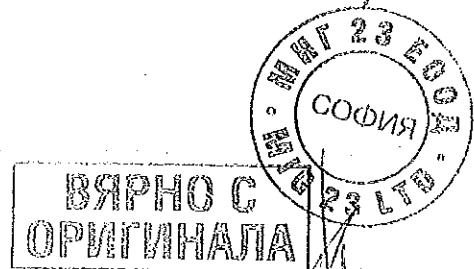
**IEC 60947-2**

TABLE: Heating Test			S1-1 (3P)
Test voltage (V): .....			—
Ambient (°C): .....		24,1 °C	—
Thermocouple Locations	max. temperature measured, (°C)	max. temperature limit, (°C)	
LINE L1	63,2	80	
LINE L2	67,2	80	
LINE L3	69,8	80	
LOAD L1	63,5	80	
LOAD L2	68,1	80	
LOAD L3	73,3	80	
Manual operating means: non-metallic	19,7	35	
Parts intended to be touched but not hand-held: non-metallic	19,3	50	
Parts which need not be touched during normal operation	40,9	60	
OCR (Over current relay)	32,9	N/A	

8.3.4.4 TABLE: Heating Test			S2-1R (3P)
Test voltage (V): .....			
Ambient (°C): .....		27,2 °C	
Thermocouple Locations	max. temperature measured, (°C)	max. temperature limit, (°C)	
LINE L1	63,9	80	
LINE L2	74,8	80	
LINE L3	63,9	80	
LOAD L1	67,6	80	
LOAD L2	75,3	80	
LOAD L3	66,1	80	

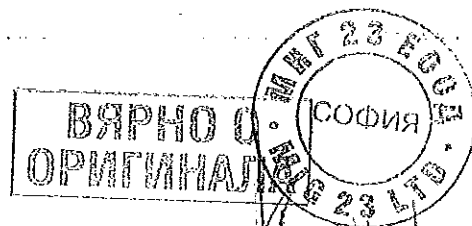

*Handwritten mark/signature*



IEC 60947-2

8.3.4.4	<b>TABLE: Heating Test</b>		S2-3 (3P)
	Test voltage (V): .....		
	Ambient (°C): .....	27,9 °C	
Thermocouple Locations	max. temperature measured, (°C)	max. temperature limit, (°C)	
LINE L1	67,0	80	
LINE L2	72,5	80	
LINE L3	66,9	80	
LOAD L1	69,7	80	
LOAD L2	78,4	80	
LOAD L3	74,9	80	

8.3.4.4	<b>TABLE: Heating Test</b>		S2-4R (3P)
	Test voltage (V): .....		
	Ambient (°C): .....	25,9 °C	
Thermocouple Locations	max. temperature measured, (°C)	max. temperature limit, (°C)	
LINE L1	63,7	80	
LINE L2	70,7	80	
LINE L3	62,9	80	
LOAD L1	67,0	80	
LOAD L2	78,9	80	
LOAD L3	69,0	80	

	<b>TABLE: Heating Test</b>		S4-1 (3P)
	Test voltage (V): .....		—
	Ambient (°C): .....	23,2 °C	—
Thermocouple Locations	max. temperature measured, (°C)	max. temperature limit, (°C)	
LINE L1	60,0	80	
LINE L2	66,8	80	
LINE L3	61,4	80	
LOAD L1	58,1	80	
LOAD L2	67,0	80	
LOAD L3	63,3	80	





IEC 60947-2

TABLE: clearance and creepage distance measurements						3P
clearance cl and creepage distance dcr at/of:	Up (V)	U r.m.s. (V)	required cl (mm)	cl (mm)	required dcr (mm)	dcr (mm)
P-P		690	8	40,3	16	49
L-A		690	8	32,9	16	32,9
C-O		690	8	31,3	16	65,79

**supplementary information:**  
P-P : Pole to Pole, L-A : Live part to accessible part, C-O : across open contacts.

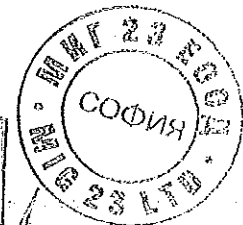

ВЯРНО С  
ОРИГИНАЛА





**IEC 60947-2**

TABLE: Heating Test			S1-1 (4P)
Test voltage (V): .....			—
Ambient (°C): .....	25,5 °C		—
Thermocouple Locations	max. temperature measured, (°C)	max. temperature limit, (°C)	
LINE L1	67,9	80	
LINE L2	66,2	80	
LINE L3	64,6	80	
LOAD L1	68,0	80	
LOAD L2	69,1	80	
LOAD L3	65,4	80	
Manual operating means: non-metallic	18,0	35	
Parts intended to be touched but not hand-held: non-metallic	17,1	50	
Parts which need not be touched during normal operation	36,7	60	
OCR (Over current relay)	36,1	N/A	

TABLE: clearance and creepage distance measurements						4P
clearance cl and creepage distance dcr at/of:	Up (V)	U r.m.s. (V)	required cl (mm)	cl (mm)	required dcr (mm)	dcr (mm)
P-P		690	8	40,3	16	49
L-A		690	8	32,9	16	32,9
C-O		690	8	31,3	16	65,79
<b>supplementary information:</b>						
P-P : Pole to Pole, L-A : Live part to accessible part, C-O : across open contacts.						

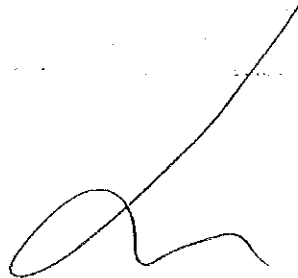

**ВЯРНО С  
ОРИГИНАЛА**

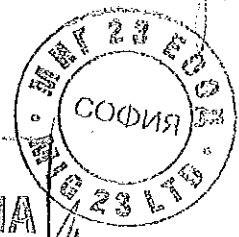
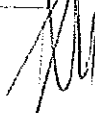
IEC 60947-2

## Time current characteristics

### 1. Instantaneous/Ground fault

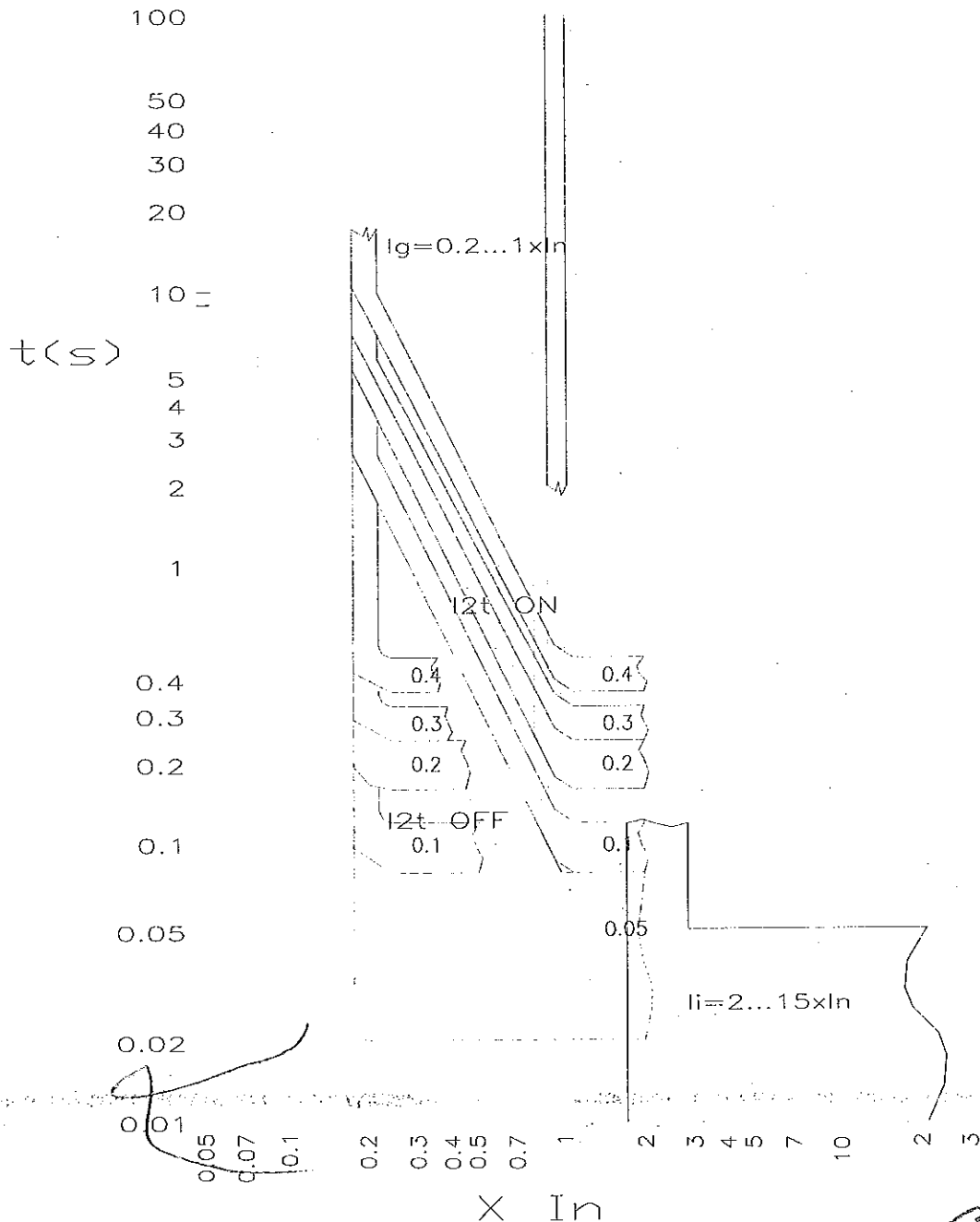

ВЯРНО С  
 ОПРИГНАЛ  
 СОФИЯ  
 23.11.2019

IEC 60947-2

2. Long time delay

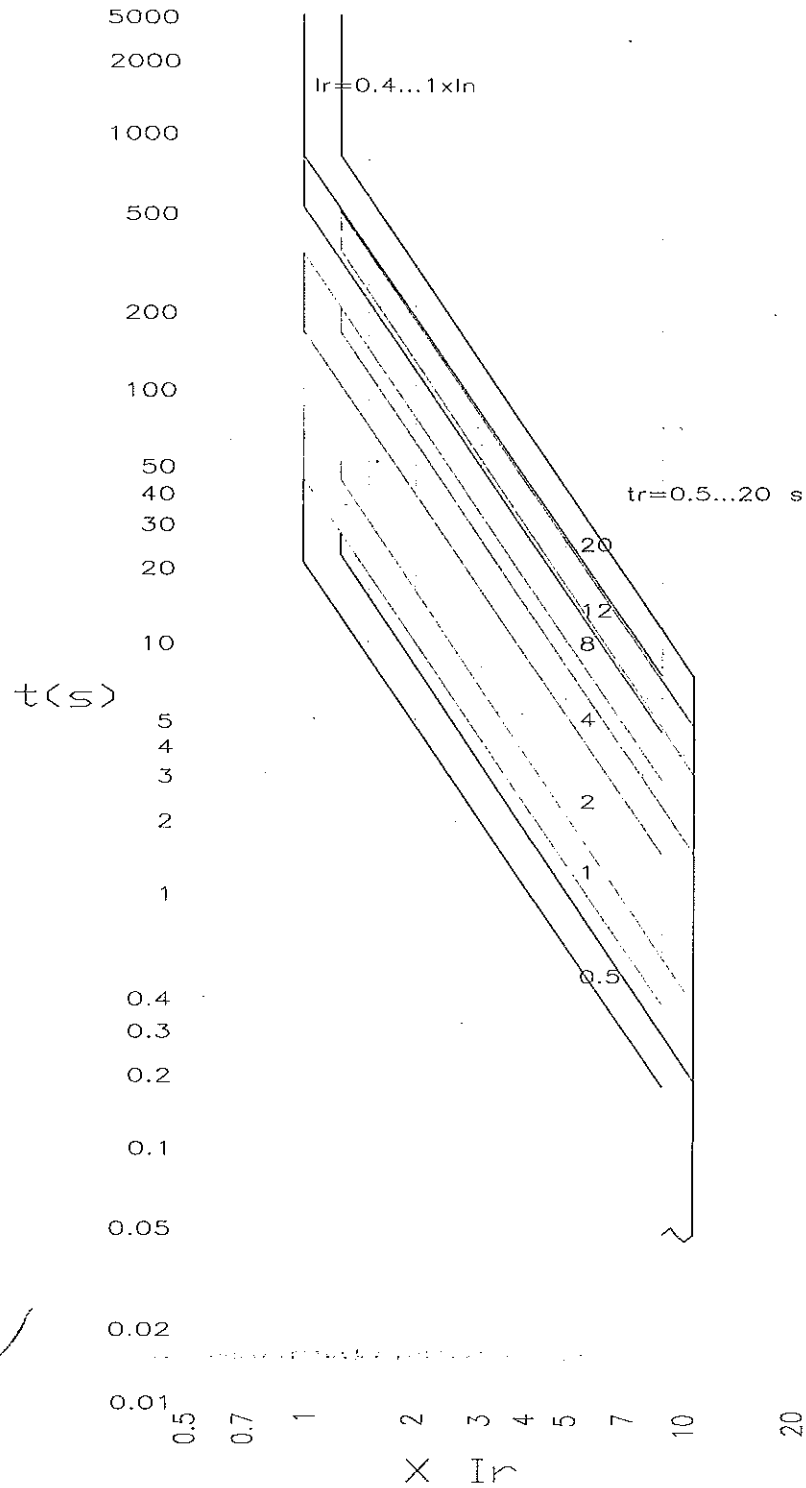

TRF No: IEC60947\_2F

*[Handwritten signature]*

ВЕРНО С  
ОРИГИНАЛОМ  
23.05.2010  
РИФОРМАТОРСКОЕ  
ПРЕДПРИЯТИЕ  
"МТБ 23170"

158

IEC 60947-2

3. Short time delay

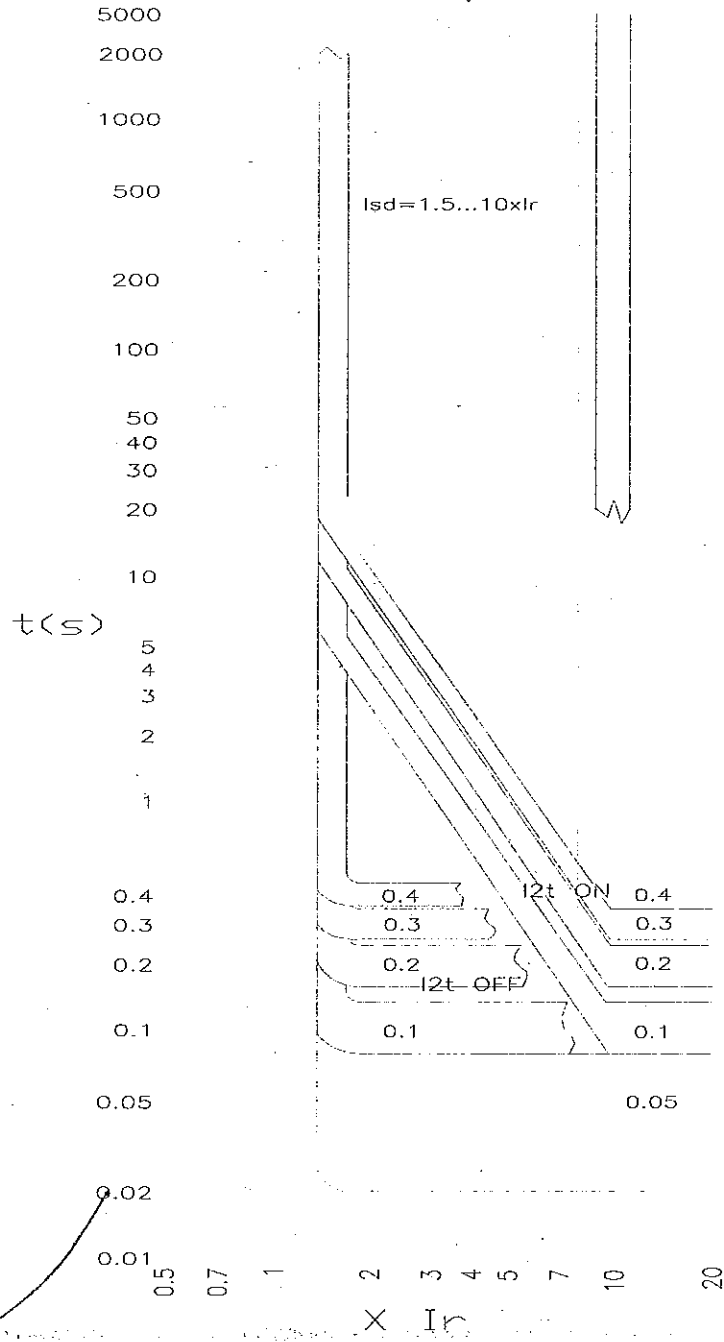

IEC 60947-2

Photographs

TS1600N 3P

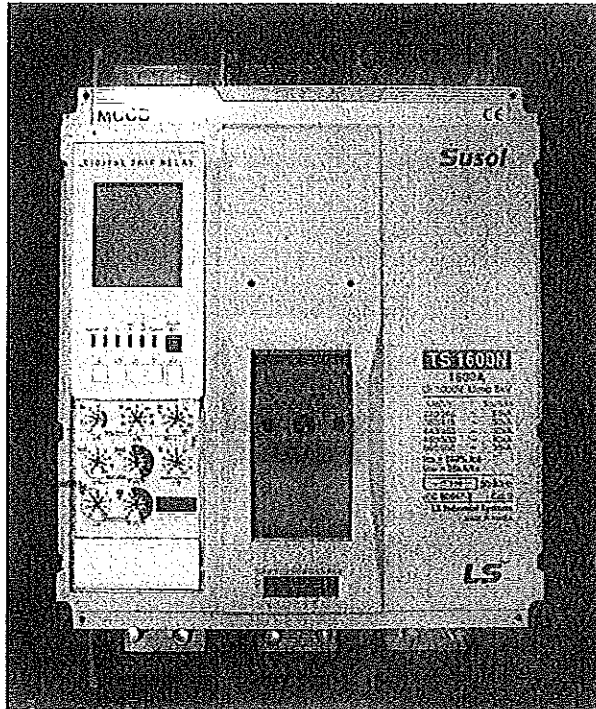

*[Handwritten signature]*

TS1600N 4P

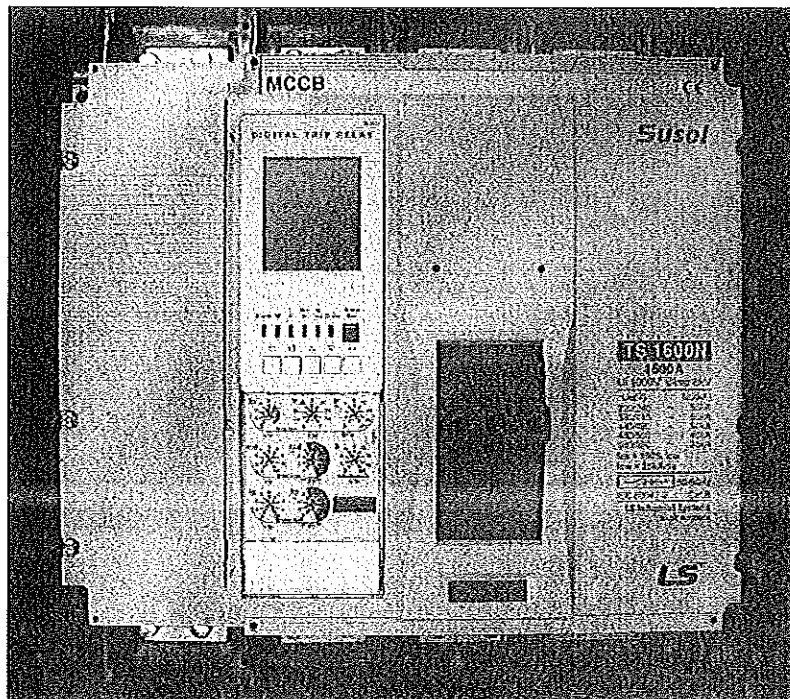

*[Handwritten signature]*

*[Handwritten signature]*

ВЯРНО С  
ОРИГИНАЛА

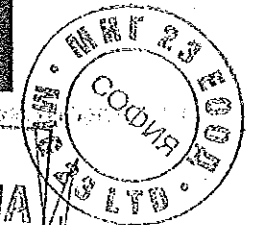

*[Handwritten signature]*

*[Handwritten signature]*

*[Handwritten signature]*

IEC 60947-2

TS1600H 3P

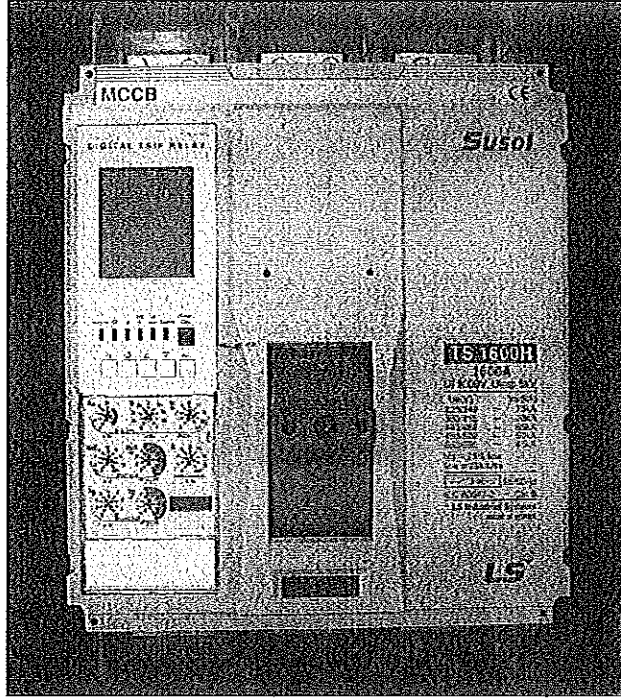

TS1600H 4P

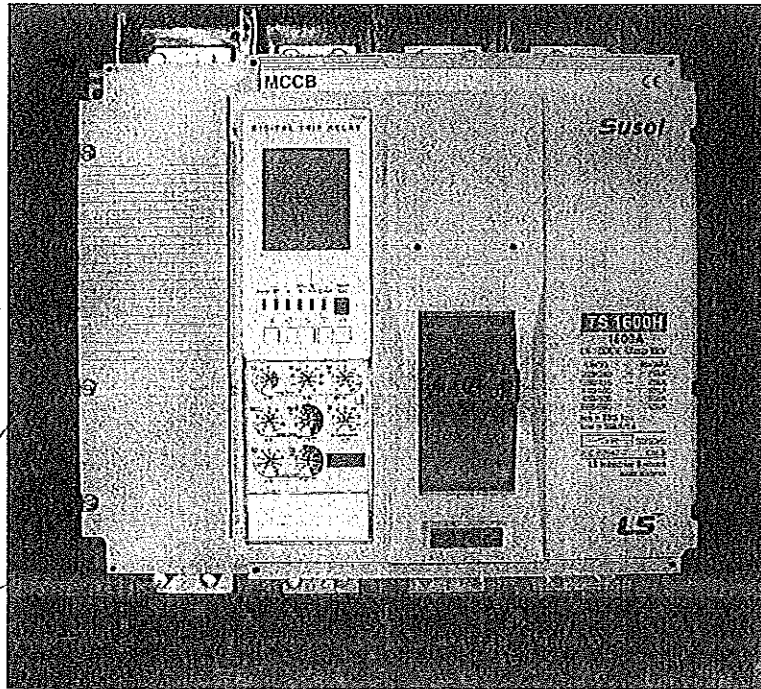

ВЕРНО  
ОРИГИНАЛ

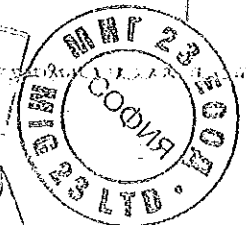

826



## СПИСЪК

на типовите изпитвания, проведени от независима изпитвателна лаборатория,  
за предлаганите триполюсни автоматични прекъсвачи, както следва:

Марка: LS Industrial Systems Co., Ltd  
Продукт: триполюсен автоматичен прекъсвач  
Серия: TS

- 5.2 Маркировка
- 7.1 Конструкция
- 8.3.3 Основни характеристики
  - 8.3.3.1 Изключващи граници и характеристики
  - 8.3.3.2 Диелектрични свойства
  - 8.3.3.3 Механични характеристики
  - 8.3.3.4 Характеристики при претоварване
  - 8.3.3.5 Проверка на диелектрична издръжливост
  - 8.3.3.6 Проверка при повишаване на температурата
  - 8.3.3.7 Проверка на сработване при претоварване
- 8.3.4 Характеристики при късо съединение
  - 8.3.4.1 Работна изключвателна възможност при късо съединение
  - 8.3.4.2 Работни характеристики
  - 8.3.4.3 Проверка на диелектрична издръжливост
  - 8.3.4.4 Проверка при повишаване на температурата
  - 8.3.4.5 Проверка на сработване при претоварване
- 8.3.5 Характеристики при късо съединение
  - 8.3.5.1 Издържан импулсен ток
  - 8.3.5.2 Изключвателна възможност при късо съединение
  - 8.3.5.3 Проверка на диелектричните свойства
  - 8.3.5.4 Проверка сработване при претоварване
- 8.3.6 Условен ток на късо съединение
  - 8.3.6.1 Проверка сработване при претоварване
  - 8.3.6.2 Издържан ток на късо съединение
  - 8.3.6.3 Проверка при повишаване на температурата
  - 8.3.6.4 Проверка на изключвателната възможност при максимален ток на късо съединение
  - 8.3.6.5 Проверка на диелектричните свойства
  - 8.3.6.6 Проверка на сработване при претоварване

ВЯРНО С  
ОРИГИНАЛА

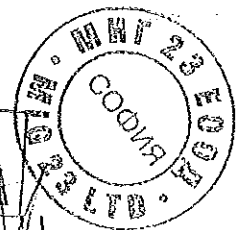

Annex to ISO/IEC 17025:2005 declaration of accreditation for registration number: L 022

of **DEKRA Certification B.V.**



This annex is valid from: 29-04-2015 to 01-03-2018

Replaces annex dated: 03-11-2014

**Location where activities are performed under accreditation**

**Head Office**

Meander 1051  
6825 MJ  
Arnhem  
The Netherlands

No.	Material or product	Type of activity	Reference number	Remarks
-----	---------------------	------------------	------------------	---------

**A. Electrical Safety Tests**

1a	Cables and cords (CABL)	Type test of cables and cords according to the tests in the standard, among others:  - electrical safety tests  - mechanical tests  - environmental tests	HD 21 HD 22 HD 603 HD 604 HD 605  EN 13501, EN 50143; EN 50214; EN 50267; EN 50525; EN 50288; EN 50399; EN 50618  NEN/EN 50200 NEN/EN/IEC 60228 NEN-EN 50525 NEN/EN 50266 NEN/EN 50362 NEN/EN /IEC 61034  IEC 60092; IEC 60227 *; IEC 60245 *; IEC 60331; IEC 60332; IEC 60502-1; IEC 60502-2; IEC 60754; IEC 60800; IEC 60840; IEC 62067	* see note 3
----	----------------------------	---	--	--------------

This annex has been approved by:

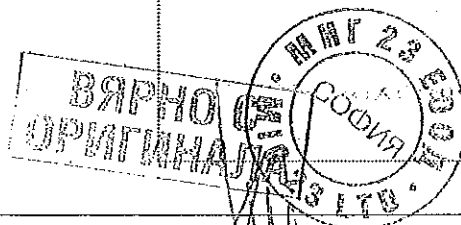

J.C. van der Poel  
Chief Executive

430

Annex to ISO/IEC 17025:2005 declaration of accreditation for registration number: L 022

of **DEKRA Certification B.V.**

This annex is valid from: **29-04-2015 to 01-03-2018**

Replaces annex dated: **03-11-2014**

No.	Material or product	Type of activity	Reference number	Remarks
1a	Cables and cords (CABL)	Type test of cables and cords according to the tests in the standard, among others:	DEKRA K 42; DEKRA K 102 DEKRA K 145; DEKRA K 146 DEKRA K 151; DEKRA K 152 DEKRA K 156; DEKRA K 157 DEKRA K 158; DEKRA K160 DEKRA K 161; DEKRA K 162 DEKRA K 163; DEKRA K 164 DEKRA K 165; DEKRA K 167 DEKRA K 168; DEKRA K 169 DEKRA K 170; DEKRA K 171 DEKRA K 175; DEKRA K 176 DEKRA K 177; DEKRA K 178 DEKRA K 179	* see note 3
		- electrical safety tests	BS 6004; BS 6007; BS 4553; BS 5467; BS 6231; BS 6346; BS 6387; BS 6500; BS 6622; BS 6724; BS 6883; BS 7211; BS 7629; BS 7835; BS 7846; BS 7889; BS 8491;	
		- mechanical tests	BS EN 50288-7 BS EN 50525	
		- environmental tests	DIN VDE0815; DIN VDE0250	
		Test methods for non-metallic materials	IEC 60811-201; IEC 60811-202 IEC 60811-203; IEC 60811-401 IEC 60811-402; IEC 60811-403 IEC 60811-404; IEC 60811-405 IEC 60811-406; IEC 60811-408 IEC 60811-409; IEC 60811-411 IEC 60811-412; IEC 60811-501 IEC 60811-502; IEC 60811-503 IEC 60811-504; IEC 60811-505 IEC 60811-506; IEC 60811-507 IEC 60811-508; IEC 60811-509 IEC 60811-510; IEC 60811-511 IEC 60811-605; IEC 60811-606 IEC 60811-607	
		Electrical test methods for low voltage energy cables	NEN-EN 50395	
		Non electrical test methods for low voltage energy cables	NEN-EN 50396	

ВЯРНО С  
ОРИГИНАЛА

831

Annex to ISO/IEC 17025:2005 declaration of accreditation for registration number: L 022

of **DEKRA Certification B.V.**

This annex is valid from: **29-04-2015 to 01-03-2018**

Replaces annex dated: **03-11-2014**

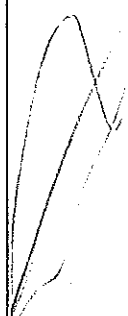
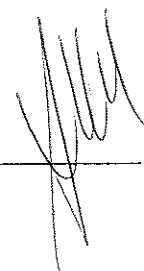
No.	Material or product	Type of activity	Reference number	Remarks
1b	Conduits	Type test of conduits according to the tests in the standard, among others: - electrical safety tests - mechanical tests - environmental tests	NEN/EN/IEC 61386 DEKRA K24 EN 50086	
1c	Installation systems Cable trays Cable ladders	Type test of cable trays and cable ladders, according to the tests in the standard, among others: - electrical safety tests - mechanical tests - environmental tests	KEMA 55 NEN/EN 50085 NEN/IEC/EN 61537 BS EN 61537	
1d	Boxes and enclosures for electrical installations	Type test of boxes and enclosures for electrical installations, according to the tests in the standard, among others: - electrical safety tests - mechanical tests - environmental tests	NEN/EN/IEC 60670	
2a	Switches for appliances and automatic controls for electrical household appliances <b>(CONT)</b>	Type test of switches according to the tests in the standard, among others: - electrical safety tests - mechanical tests - environmental tests.	IEC/EN 60730*, 61095* IEC/EN 60691, 60934, 61058*, 60529 IEC 60265, 62271-1, 62271-100, 62271-101, 62271-102, 62271-105, 62271-110, 62271-200, 62271-201, 62271-202, 62271-203, EN 50152-1 IEEE Std C37.09, C37.081, 37.60, C37.013, C37.34, ANSI C37.41, C37.73, C37.20.2, C37.122 ANSI/IEEE C37.21 ANSI C37.54, C37.55, C37.20.2, C37.72	* see note 3 



832

Annex to ISO/IEC 17025:2005 declaration of accreditation for registration number: L 022

of **DEKRA Certification B.V.**

This annex is valid from: **29-04-2015 to 01-03-2018**

Replaces annex dated: **03-11-2014**

No.	Material or product	Type of activity	Reference number	Remarks
3	Household and similar equipment (HOUS)	Type test of household equipment according to the tests in the standard, among others:	IEC/EN 60335* IEC/EN 61770 IEC/EN 62233 EN 50366 IEC/EN 60204 IEC/EN 60730-1/2-8/2-9 IEC/EN 61558-1/2-3/2-6/2-5/2-6/2-16 IEC/EN 62061 EN/ISO 13849-1	* see note 3
		- electrical safety tests - mechanical tests - environmental tests		
		Low power measurements	IEC/EN 62301	
4	Installation accessories and connection devices (INST)	Type test of installation accessories and connection devices according to the tests in the standard, among others:	IEC/EN 60309*, 60320*, 60669*, 60670*, 60799*, 60884*, 60998*, 61058*, 61242*, 61534*, 61984*, 62208*; IEC/EN 60335-2-76, 60974, 61316, 61386, 62094 EN 50075, 50066, 50146, 50250, 50393 NEN 1251, IEC 60884*, 61238, 62080 BS 1363-1, BS 1363-2, BS 1363-3, BS 1363-4 SS 145 BS 546 BS 4573 BS 5733 NEN 1020 NF C61-314 DIN VDE 0620-1 DIN VDE 0620-2-1 CEI 23-50 NBN C 61-112-1 NEK IEC 60884-1 NEK 502 ÖVE/ÖNORM E 8684-1 ÖVE/ÖNORM E 8620-2(-3,-4,-5) SFS 5610 SS 428-08 34 DS 60884-2-D1 SEV 1011 UNE 20315-1-1; UNE 20315-1-2 IEC/EN 61535 EN 50428 required with 60669	* see note 3

ВЯРНО С  
ОРИГИНАЛА

23 FEB 2015

825

Annex to ISO/IEC 17025:2005 declaration of accreditation for registration number: **L 022**

of **DEKRA Certification B.V.**



This annex is valid from: **29-04-2015** to **01-03-2018**

Replaces annex dated: **03-11-2014**

No.	Material or product	Type of activity	Reference number	Remarks
5	Luminaire (LITE)	Type test of luminaire according to the tests in the standard, among others: - electrical safety tests - mechanical tests - environmental tests	IEC/EN 60155*, 60238*, 60400*, 60570*, 60598*, 60838*, 60921*, 60968*, 60969*, 61347*, 62471* IEC/EN 60929, 61184, 62031, 62035, 60923, 60925, 60927, 61047, 62384, 62560, 61195, 62493	* see note 3
6	Measurement, control and laboratory equipment (MEAS)	Type test of measurement-, control- and laboratory equipment according to the tests in the standard, among others: - electrical safety tests - mechanical tests - environmental tests	IEC/EN 61010* IEC/EN 60044  IEC/EN 61243 IEEE Std C57.13	* see note 3
7	Electrical equipment for medical use (MED)	Type test of electrical equipment for medical use according to the tests in the standard, among others: - electrical safety tests - mechanical tests - environmental tests	IEC/EN 60601* IEC/EN/ISO 80601 HD 395	* see note 3
8	Miscellaneous equipment (MISC)	Type test of miscellaneous equipment according to the tests in the standard, among others: - electrical safety tests - mechanical tests - environmental tests	IEC/EN 60825*	* see note 3

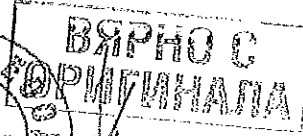

Annex to ISO/IEC 17025:2005 declaration of accreditation for registration number: **L 022**

of **DEKRA Certification B.V.**



This annex is valid from: **29-04-2015 to 01-03-2018**

Replaces annex dated: **03-11-2014**

No.	Material or product	Type of activity	Reference number	Remarks
9	IT and office equipment <b>(OFF)</b>	Type test of IT and office equipment according to the tests in the standard, among others:  - electrical safety tests  - mechanical tests  - environmental tests	IEC/EN 60950* IEC/EN 62040* IEC/EN 60825 IEC 62368 EN 41003	* see note 3
10	Low voltage, high power switching equipment <b>(POW)</b>	Type test of low voltage, high power switching equipment according to the tests in the standard, among others:  - electrical safety tests  - mechanical tests  - environmental tests	IEC/EN 60439*, 61439, IEC/EN 60947* IEC/EN 60282, 62208 EN 50178, IEC 60470, 60549, 60644, EN 60282-1 IEEE Std C37.41, C37.60 ANSI C37.44 IEC 61921	* see note 3
11	Installation protective equipment <b>(PROT)</b>	Type test of installation protective equipment according to the tests in the standard, among others:  - electrical safety tests  - mechanical tests  - environmental tests	IEC/EN 60127*, 60269*, 60529*, 60898*, 61008*, 61009*, 61643*, 60755, 62019 IEC 60099, 60137, 60168, 60383, 60507, 60660, 61109, 60815 HD 630, 639, 60269 IEEE Std 62.11 ANSI C29 CAN/CSA C411.1	* see note 3
12	Safety transformers and similar equipment <b>(SAFE)</b>	Type test of safety transformers and similar equipment according to the tests in the standard, among others:  - electrical safety tests  - mechanical tests  - environmental tests	IEC/EN 60044*, IEC/EN 61558* IEC/EN 62040, IEC/EN 60076, IEC/EN 60353 EN 50091, EN 50464-1 HD 538.1 IEEE Std. C57.12.90, C57.21 NEMA 107 CISPR 16	* see note 3

Handwritten signature or scribble in the bottom left area.

**ВЯРНО С  
ОРИГИНАЛА**

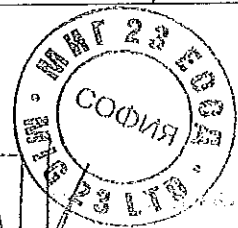

838

Annex to ISO/IEC 17025:2005 declaration of accreditation for registration number: L 022

of **DEKRA Certification B.V.**

This annex is valid from: **29-04-2015 to 01-03-2018**

Replaces annex dated: **03-11-2014**

No.	Material or product	Type of activity	Reference number	Remarks
13	Electric tools (TOOL)	Type test of electric tools according to the tests in the standard, among others:  - electrical safety tests  - mechanical tests  - environmental tests	IEC/EN 60745* IEC/EN 61029* IEC/EN 60335* (Gardening) IEC/EN 62233, IEC/EN 60204 EN 50144 EN 50260-2-7 EN 792 EN/ISO 1114 IEC/EN 62061 EN/ISO 13849-1	* see note 3
14	Electronics, entertainment equipment (TRON)	Type test according to the tests as mentioned in the standard, except the following tests which are subcontracted:  60065, cl. 20.1.3 Pre-conditioning of printed circuit boards 60065, cl. 12.1.2 Vibration-sine	IEC / EN 60065* IEC / EN 60491 IEC 62368	* see note 3
15	Products within the scope of the EMC Directive 2004/108/EC (EMC)	Type test according to the tests as mentioned in the standard	CISPR11; CISPR12; CISPR13; CISPR14-*; CISPR15; CISPR16-*-*; CISPR20; CISPR22; CISPR24; CISPR25; IEC60601-*-*; IEC60945; IEC60947-*-*; IEC61000-*-*; IEC61008-1; IEC61009-1; IEC61131-2; IEC61204-3; IEC61326-*; IEC61543; IEC61547; IEC61800-*; IEC62040-2; IEC62052-*; IEC62053-*; IEC62054-*;	* see note 3

**B. Electromagnetic Compatibility (EMC): Automotive tests**

1	Vehicles, Motorcycles, Motorboats and Spark-ignited engine-driven devices	Radiated emission 30 to 1000 MHz OATS	European Directives 2004/104/EC, 97/24/EC  European regulation ECE-R10.04  EN 55012, CISPR 12	
2	Vehicles, Motorcycles, Motorboats and Spark-ignited engine-driven devices	Radiated immunity up to 30 V/m 20 to 2000 MHz OATS	European Directive 2004/104, 97/24/EC  European regulation ECE-R10.04	

ВЯРНО С  
КОПИРИНАЛА  
МИГ 23 ЛТД.  
СОФИЯ



Annex to ISO/IEC 17025:2005 declaration of accreditation for registration number: L 022

of **DEKRA Certification B.V.**

This annex is valid from: **29-04-2015 to 01-03-2018**

Replaces annex dated: **03-11-2014**

No.	Material or product	Type of activity	Reference number	Remarks
3	Electrical/ electronic sub-assembly	Pulse emission for ESA's along supply lines 12V and 24V	European Directive 2004/104/EC  European regulation ECE-R10.04 ISO 7637-1 ISO 7637-2	
4		Conducted emission for ESA's (V-method, LISN) 150 kHz to 108 MHz	European Directive 2004/104/EC  European regulation ECE-R10.04  CISPR25	
5		Radiated emission for ESA's Anechoic Chamber method 30 to 1000 MHz	European Directive 2004/104/EC  European regulation ECE-R10.04  CISPR25	
6		Radiated immunity for ESA's Anechoic Chamber method and GTEM method 20 to 2000 MHz up to 30V/m	European Directive 2004/104/EC  European regulation ECE-R10.04  ISO 11452-1, ISO 11452-2, ISO 11452-3	
7	Electrical/ electronic sub-assembly	Bulk Current Injection for ESA's 20 to 400 MHz up to 100 mA	European Directive 2004/104/EC  European regulation ECE-R10.04  ISO 11452-1, ISO 11452-4	
8		Pulse immunity for ESA's along supply lines 12V and 24V	European Directive 2004/104/EC  European regulation ECE-R10.04  ISO 7637-1 ISO 7637-2	

**C. Electromagnetic Compatibility (EMC): EMF tests**

1	Electrical and electronic equipment	EMF measurements: 0-400 kHz	EN 62233  EN 62493	
---	--	--------------------------------	--------------------------	--

**ВЕРНО С  
ОРИГИНАЛА**

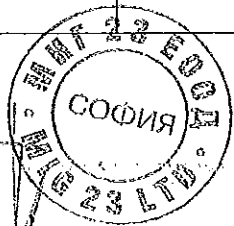

Annex to ISO/IEC 17025:2005 declaration of accreditation for registration number: **L 022**

of **DEKRA Certification B.V.**

This annex is valid from: **29-04-2015** to **01-03-2018**

Replaces annex dated: **03-11-2014**

No.	Material or product	Type of activity	Reference number	Remarks
-----	---------------------	------------------	------------------	---------

**D. Electromagnetic Compatibility (EMC): Emission tests**

1	Electrical and electronic equipment	Conducted emission 9 kHz to 30 MHz	EN 55011, CISPR 11 EN 55013, CISPR 13 EN 55014-1, CISPR 14-1 EN 55015, CISPR 15 EN 55022, CISPR 22	
2		Radiated Emission Electric (EM) Field 30 MHz to 18 GHz	EN 55011, CISPR 11 EN 55014-1, CISPR 14-1 EN 55022, CISPR 22	
3		Disturbance power 30 MHz to 300 MHz	EN 55014-1, CISPR 14-1	
4		Click disturbances 150 kHz to 30 MHz	EN 55011, CISPR 11 EN 55014-1, CISPR 14-1	
5		Radiated Emission Magnetic Field 9 kHz to 30 MHz	EN 55011, CISPR 11 EN 55015, CISPR 15	
6		Harmonic current emissions 0 Hz to 2 kHz up to 16 A per phase	IEC / EN 61000-3-2	
7		Pulse magnetic field immunity up to 1000 A/m	IEC/EN 61000-4-9	
8		Limitation of voltage fluctuations and flicker up to 16 A per phase	IEC / EN 61000-3-3	

**E. Electromagnetic Compatibility (EMC): FCC tests (USA legislation)**

1	Radio-Frequency Devices Industrial, Scientific and Medical Equipment	Emission 9 kHz to 3 GHz	47 CFR FCC Part 15, Part 18 ANSI C63.4 FCC MP-5	
---	---	----------------------------	---	--

**F. Electromagnetic Compatibility (EMC): Immunity test**

1	Electric and electronic equipment	Electrostatic discharge immunity up to 30 kV	IEC/EN 61000-4-2	
2		Radiated EM field immunity up to 2,5 GHz up to 30 V/m	IEC/EN 61000-4-3	
3		EFT Burst immunity up to 4 kV	IEC/EN 61000-4-4	

